

visual engineering  
**LIGHTWARE**

**User's Manual**



**HDMI-TPS-TX210**  
**HDMI-TPS-TX220**  
**DVI-HDCP-TPS-TX210**  
**DVI-HDCP-TPS-TX220**  
**DP-TPS-TX210**  
**DP-TPS-TX220**  
**SW4-TPS-TX240**

HDBaseT™ Multimedia Extender

## Important Safety Instructions

### Class II apparatus construction.

The equipment should be operated only from the power source indicated on the product.

To disconnect the equipment safely from power, remove the power cord from the rear of the equipment, or from the power source. The MAINS plug is used as the disconnect device, the disconnect device shall remain readily operable.

There are no user-serviceable parts inside of the unit. Removal of the cover will expose dangerous voltages. To avoid personal injury, do not remove the cover. Do not operate the unit without the cover installed.

The appliance must be safely connected to multimedia systems. Follow instructions described in this manual.

### Ventilation

For the correct ventilation and to avoid overheating ensure enough free space around the appliance. Do not cover the appliance, let the ventilation holes free and never block or bypass the ventilators (if any).

### WARNING

To prevent injury, the apparatus is recommended to securely attach to the floor/wall or mount in accordance with the installation instructions. The apparatus shall not be exposed to dripping or splashing and that no objects filled with liquids, such as vases, shall be placed on the apparatus. No naked flame sources, such as lighted candles, should be placed on the apparatus.

## Waste Electrical & Electronic Equipment WEEE

This marking shown on the product or its literature, indicates that it should not be disposed with other household wastes at the end of its working life. To prevent possible harm to the environment or human health from uncontrolled waste disposal, please separate this from other types of wastes and recycle it responsibly to promote the sustainable reuse of material resources. Household users should contact either the retailer where they purchased this product, or their local government office, for details of where and how they can take this item for environmentally safe recycling. Business users should contact their supplier and check the terms and conditions of the purchase contract. This product should not be mixed with other commercial wastes for disposal.

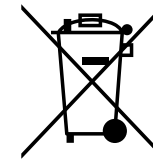

## Common Safety Symbols

Symbol	Description
	Direct current
	Alternating current
	Double insulation
	Caution, possibility of electric shock
	Caution

## Symbol Legend

The following symbols and markings are used in the document:

**WARNING!** Safety-related information which is highly recommended to read and keep in every case!

**ATTENTION!** Useful information to perform a successful procedure; it is recommended to read.

**INFO:** A notice which may contain additional information. Procedure can be successful without reading it.

**DEFINITION:** The short description of a feature or a function.

**TIPS AND TRICKS:** Ideas which you may have not known yet but can be useful.

## Navigation Buttons

 Go back to the previous page. If you clicked on a link previously, you can go back to the source page by the button.

 Navigate to the Table Contents.

 Step back one page.

 Step forward to the next page.

## Document Information

This User's Manual applies to the following versions of the mentioned software, firmware, and hardware:

Item	Version
Lightware Device Controller (LDC) software	1.17.1.b3
Lightware Device Updater (LDU) software	1.5.0b8
Controller firmware	1.1.1
Hardware	1.2

Document revision: **2.1**

Release date: 31-10-2018

Editor: Laszlo Zsedenyi

# Table of Contents

<b>1. INTRODUCTION</b> .....	<b>7</b>	<b>3.11. FURTHER BUILT-IN FEATURES</b> .....	<b>20</b>	5.6.2. EDID Summary Window .....	31
1.1. DESCRIPTION.....	7	3.11.1. Automatically Launched Actions – The Event Manager.....	20	5.6.3. Editing an EDID .....	31
1.2. COMPATIBLE DEVICES .....	7	3.11.2. Transmitter Cloning – Configuration Backup and Restore.....	20	5.6.4. Creating an EDID - Easy EDID Creator .....	32
1.3. BOX CONTENTS .....	7	3.11.3. Remote Firmware Upgrade of Connected Lightware Devices...	20	<b>5.7. CONTROL MENU</b> .....	<b>32</b>
1.4. FEATURES .....	8	<b>4. OPERATION</b> .....	<b>21</b>	5.7.1. RS-232 .....	32
1.5. MODEL COMPARISON .....	8	<b>4.1. FRONT PANEL LEDs</b> .....	<b>21</b>	5.7.2. GPIO .....	33
1.6. TYPICAL APPLICATION .....	8	4.1.1. Video Input LEDs .....	21	5.7.3. Ethernet.....	33
<b>2. INSTALLATION</b> .....	<b>10</b>	4.1.2. Audio Input LEDs .....	21	5.7.4. Infra .....	34
2.1. MOUNTING OPTIONS .....	10	4.1.3. HDCP LED .....	21	<b>5.8. EVENT MANAGER</b> .....	<b>35</b>
2.1.1. 1U High Rack Shelf.....	10	4.1.4. Autoselect LED .....	21	5.8.1. The Event Editor.....	36
2.1.2. Under-desk Double Mounting Kit.....	10	<b>4.2. FRONT PANEL BUTTONS</b> .....	<b>21</b>	5.8.2. Create or Modify an Event.....	36
2.2. CONNECTING STEPS.....	11	4.2.1. Video Select Button.....	21	5.8.3. Special Tools and Accessories.....	37
2.3. POWERING OPTIONS.....	11	4.2.2. Audio Select Button.....	21	5.8.4. Clear One or More Event(s).....	37
<b>3. PRODUCT OVERVIEW</b> .....	<b>12</b>	4.2.3. Programmable Show Me Button .....	22	5.8.5. Export and Import Events .....	37
3.1. FRONT VIEW .....	12	<b>4.3. SPECIAL FUNCTIONS</b> .....	<b>22</b>	5.8.6. Event Creating - Example .....	37
3.2. REAR VIEW .....	13	4.3.1. Enable DHCP (Dynamic) IP Address .....	22	<b>5.9. SETTINGS MENU</b> .....	<b>38</b>
3.3. ELECTRICAL CONNECTIONS .....	13	4.3.2. Reset to Factory Default Settings.....	22	5.9.1. Status .....	38
3.3.1. DVI-I Connector.....	13	4.3.3. Resetting the Device.....	22	5.9.2. Network.....	39
3.3.2. HDMI Connector .....	13	4.3.4. Control Lock.....	22	5.9.3. Backup .....	39
3.3.3. DisplayPort Connector .....	14	4.3.5. Entering Firmware Upgrade Mode.....	22	5.9.4. System .....	39
3.3.4. Ethernet Connector (TPS and LAN Ports) .....	14	<b>4.4. REAR PANEL STATUS LEDs</b> .....	<b>22</b>	<b>5.10. CONFIGURATION CLONING (BACKUP TAB)</b> .....	<b>40</b>
3.3.5. 12V DC Connection .....	14	4.4.1. LIVE LED.....	22	5.10.1. Steps in a Nutshell .....	40
3.3.6. Analog Stereo Audio.....	14	4.4.2. RS-232 LED .....	22	5.10.2. Save the Settings of a Device (Backup).....	40
3.3.7. RS-232 Connector.....	14	4.4.3. SRVC LED .....	22	5.10.3. Upload the Settings to a Device (Restore).....	40
3.3.8. IR Connector .....	14	4.4.4. LINK LED .....	22	<b>5.11. ADVANCED VIEW WINDOW</b> .....	<b>41</b>
3.3.9. GPIO - General Purpose Input/Output Ports.....	15	<b>4.5. SOFTWARE CONTROL MODES</b> .....	<b>23</b>	<b>6. LW2 PROGRAMMER'S REFERENCE</b> .....	<b>42</b>
3.4. TPS EXTENDER CONCEPT .....	15	<b>5. SOFTWARE CONTROL - LIGHTWARE DEVICE CONTROLLER</b> ....	<b>24</b>	6.1. LW2 PROTOCOL DESCRIPTION.....	42
3.5. PORT DIAGRAM .....	15	5.1. INSTALL AND UPGRADE .....	24	6.2. GENERAL LW2 COMMANDS.....	42
3.6. TPS INTERFACE.....	16	5.2. ESTABLISHING THE CONNECTION.....	24	6.2.1. View Product Type.....	42
3.7. AUDIO INTERFACE .....	16	5.3. CROSSPOINT MENU.....	25	6.2.2. Query Control Protocol.....	42
3.7.1. Audio Input Modes .....	16	5.4. PORT PROPERTIES WINDOWS.....	26	6.2.3. View Firmware Version of the CPU .....	43
3.7.2. Audio Options - Example.....	16	5.4.1. Digital Video Inputs .....	26	6.2.4. Connection Test.....	43
3.8. VIDEO INTERFACE .....	17	5.4.2. Digital Audio Inputs .....	26	6.2.5. View Serial Number .....	43
3.8.1. Video Input Modes .....	17	5.4.3. Analog Audio Input.....	27	6.2.6. Compile Time.....	43
3.8.2. Input Source Selection Modes.....	17	5.4.4. Video Outputs (TPS and HDMI).....	27	6.2.7. View Installed Board.....	43
3.9. THE AUTOSELECT FEATURE.....	17	5.4.5. Audio Outputs (TPS and HDMI).....	28	6.2.8. View Firmware for All Controllers.....	43
3.10. CONTROL FEATURES.....	18	<b>5.5. DIAGNOSTIC TOOLS</b> .....	<b>28</b>	6.2.9. Restart the Device .....	43
3.10.1. Serial Interface .....	18	5.5.1. Cable Diagnostics.....	28	6.2.10. Query Health Status .....	43
3.10.2. IR Interface.....	19	5.5.2. Frame Detector .....	29	6.2.11. Restore Factory Default Settings.....	43
3.10.3. Ethernet Control Interface .....	19	5.5.3. No Sync Screen (Test Pattern) .....	29	<b>6.3. A/V PORT SETTINGS</b> .....	<b>44</b>
3.10.4. GPIO Interface .....	20	<b>5.6. EDID MENU</b> .....	<b>30</b>	6.3.1. Switch an Input to the Output .....	44
		5.6.1. EDID Operations.....	30	6.3.2. Mute Output .....	44
				6.3.3. Unmute Output .....	44



## Table of Contents

6.3.4. Lock Output.....	44	7.6.2. Query the Status of Destination Port .....	58	7.8.4. Change the IP Address (Static) .....	66
6.3.5. Unlock Output .....	44	7.6.3. Query the Video Crosspoint Setting .....	58	7.8.5. Query the Subnet Mask.....	66
6.3.6. View Connection State on the Output .....	45	7.6.4. Switching Video Input .....	58	7.8.6. Change the Subnet Mask (Static).....	66
6.3.7. View Crosspoint Size.....	45	7.6.5. Query the Video Autoselect Settings.....	58	7.8.7. Query the Gateway Address .....	66
6.3.8. Change Video Autoselect Mode.....	45	7.6.6. Change the Autoselect Mode .....	58	7.8.8. Change the Gateway Address (Static) .....	66
6.3.9. Change Audio Autoselect Mode.....	45	7.6.7. Query the Input Port Priority .....	59	<b>7.9. RS-232 PORT CONFIGURATION .....</b>	<b>66</b>
6.3.10. Change the Video Input Priorities.....	46	7.6.8. Change the Input Port Priority .....	59	7.9.1. Protocol Setting.....	66
6.3.11. Change Audio Input Priority.....	46	7.6.9. Mute an Input Port.....	59	7.9.2. BAUD Rate Setting.....	67
<b>6.4. NETWORK CONFIGURATION .....</b>	<b>46</b>	7.6.10. Unmute an Input Port.....	59	7.9.3. Databit Setting.....	67
6.4.1. Query the Current IP Status .....	46	7.6.11. Lock an Input Port.....	59	7.9.4. Stopbits Setting .....	67
6.4.2. Set the IP Address .....	46	7.6.12. Unlock an Input Port.....	59	7.9.5. Parity Setting.....	67
6.4.3. Set the Subnet Mask .....	46	7.6.13. Mute Output.....	59	7.9.6. RS-232 Operation Mode .....	67
6.4.4. Set the Gateway Address.....	47	7.6.14. Unmute Output .....	60	<b>7.10. INFRARED PORT CONFIGURATION .....</b>	<b>68</b>
6.4.5. Apply Network Settings.....	47	7.6.15. Lock Output .....	60	7.10.1. Enable Command Injection Mode.....	68
<b>6.5. GPIO CONFIGURATION.....</b>	<b>47</b>	7.6.16. Unlock Output.....	60	7.10.2. Enable/Disable Output Signal Modulation.....	68
6.5.1. Set Level and Direction for Each Pins .....	47	7.6.17. HDCP Setting (Input Port).....	60	<b>7.11. SENDING MESSAGE VIA THE COMMUNICATION PORTS .....</b>	<b>68</b>
<b>6.6. LW2 COMMANDS – QUICK SUMMARY .....</b>	<b>48</b>	7.6.18. HDCP Setting (Output Port).....	60	7.11.1. Sending Message via TCP Port.....	68
<b>7. LW3 PROGRAMMER'S REFERENCE .....</b>	<b>49</b>	7.6.19. Test Pattern Generator.....	60	7.11.2. Sending Message via UDP Port.....	68
<b>7.1. OVERVIEW .....</b>	<b>49</b>	7.6.20. HDMI Mode Settings (Output Port).....	61	7.11.3. Sending Message via an RS-232 Port.....	69
7.1.1. Elements of the Tree Structure.....	49	7.6.21. Query the Recent TPS Mode.....	61	<b>7.12. GPIO PORT CONFIGURATION.....</b>	<b>69</b>
7.1.2. Escaping.....	51	7.6.22. TPS Mode Settings.....	61	7.12.1. Set the Direction of a GPIO Pin.....	69
7.1.3. Error Messages.....	51	<b>7.7. AUDIO PORT SETTINGS.....</b>	<b>62</b>	7.12.2. Set the Output Level of a GPIO Pin.....	70
7.1.4. Prefix Summary .....	51	7.7.1. Query the Status of Source Ports .....	62	7.12.3. Toggle the Level of a GPIO Pin .....	70
<b>7.2. THE TREE STRUCTURE OF THE TRANSMITTER .....</b>	<b>51</b>	7.7.2. Query the Status of Destination Port .....	62	<b>7.13. EDID MANAGEMENT.....</b>	<b>70</b>
<b>7.3. LW3 COMMANDS .....</b>	<b>52</b>	7.7.3. Query the Audio Crosspoint Setting .....	63	7.13.1. Query the Emulated EDIDs.....	70
7.3.1. Get Command.....	52	7.7.4. Switching Audio Input .....	63	7.13.2. Query the Validity of a Dynamic EDID .....	70
7.3.2. Set Command .....	53	7.7.5. Query the Audio Autoselect Settings .....	63	7.13.3. Query the Preferred Resolution of a User EDID .....	70
7.3.3. Invocation .....	53	7.7.6. Change the Autoselect Mode .....	63	7.13.4. Emulating an EDID to an Input Port.....	70
7.3.4. Manual .....	54	7.7.7. Query the Input Port Priority .....	64	7.13.5. Emulating an EDID to All Input Ports.....	70
7.3.5. Signature.....	54	7.7.8. Change the Input Port Priority .....	64	7.13.6. Copy an EDID to User Memory .....	70
7.3.6. Subscription.....	54	7.7.9. Mute an Audio Input .....	64	7.13.7. Deleting an EDID from User Memory .....	71
7.3.7. Notifications about the Changes of the Properties .....	55	7.7.10. Unmute an Audio Input .....	64	7.13.8. Resetting the Emulated EDIDs.....	71
<b>7.4. FORMAL DEFINITIONS.....</b>	<b>55</b>	7.7.11. Lock an Input Port.....	64	<b>7.14. LW3 COMMANDS - QUICK SUMMARY .....</b>	<b>72</b>
<b>7.5. SYSTEM COMMANDS.....</b>	<b>56</b>	7.7.12. Unlock an Input Port.....	64	<b>8. FIRMWARE UPGRADE .....</b>	<b>75</b>
7.5.1. Query the Product Name.....	56	7.7.13. Mute Audio Output .....	64	<b>8.1. ABOUT THE FIRMWARE PACKAGE (LFP FILE).....</b>	<b>75</b>
7.5.2. Set the Device Label.....	56	7.7.14. Unmute Audio Output.....	65	<b>8.2. SHORT INSTRUCTIONS.....</b>	<b>75</b>
7.5.3. Query the Serial Number .....	56	7.7.15. Lock Output .....	65	<b>8.3. INSTALL AND UPGRADE .....</b>	<b>75</b>
7.5.4. Query the Firmware Version .....	56	7.7.16. Unlock Output.....	65	<b>8.4. DETAILED INSTRUCTIONS.....</b>	<b>76</b>
7.5.5. Resetting the Device.....	56	7.7.17. Analog Audio Input Level Settings .....	65	8.4.1. Establish the Connection .....	76
7.5.6. Restore the Factory Default Settings .....	56	<b>7.8. NETWORK CONFIGURATION .....</b>	<b>65</b>	8.4.2. Start the LDU and Follow the Instructions .....	76
<b>7.6. VIDEO PORT SETTINGS .....</b>	<b>57</b>	7.8.1. Query the DHCP State .....	65	<b>8.5. KEEPING THE CONFIGURATION SETTINGS .....</b>	<b>79</b>
7.6.1. Query the Status of Source Ports.....	57	7.8.2. Change the DHCP State .....	66	<b>8.6. REMOTE FIRMWARE UPGRADE OF CONNECTED LIGHTWARE DEVICES ...</b>	<b>80</b>
		7.8.3. Query the IP Address.....	66		

## Table of Contents

<b>9. TROUBLESHOOTING .....</b>	<b>81</b>
<b>10. TECHNOLOGIES .....</b>	<b>83</b>
<b>10.1. EDID MANAGEMENT.....</b>	<b>83</b>
10.1.1. Understanding the EDID .....	83
10.1.2. Advanced EDID Management.....	83
<b>10.2. HDCP MANAGEMENT .....</b>	<b>84</b>
10.2.1. Protected and Unprotected Content .....	84
10.2.2. Disable Unnecessary Encryption.....	84
<b>10.3. PIXEL ACCURATE RECLOCKING .....</b>	<b>85</b>
<b>11. APPENDIX .....</b>	<b>86</b>
<b>11.1. SPECIFICATION .....</b>	<b>86</b>
<b>11.2. CONTENT OF BACKUP FILE.....</b>	<b>87</b>
<b>11.3. FACTORY DEFAULT SETTINGS.....</b>	<b>88</b>
<b>11.4. MAXIMUM EXTENSION DISTANCES.....</b>	<b>88</b>
<b>11.5. PORT NUMBERING.....</b>	<b>89</b>
11.5.1. For All Models.....	89
11.5.2. HDMI-TPS-TX210 .....	89
11.5.3. HDMI-TPS-TX220 .....	89
11.5.4. DVI-HDCP-TPS-TX210.....	89
11.5.5. DVI-HDCP-TPS-TX220.....	89
11.5.6. DP-TPS-TX210.....	89
11.5.7. DP-TPS-TX220.....	89
11.5.8. SW4-TPS-TX240 .....	90
<b>11.6. MECHANICAL DRAWINGS .....</b>	<b>90</b>
<b>11.7. FACTORY EDID LIST .....</b>	<b>91</b>
<b>11.8. FURTHER INFORMATION.....</b>	<b>92</b>

# 1

## Introduction

Thank You for choosing Lightware's HDMI-TPS-TX200 series device. In the first chapter we would like to introduce the device highlighting the most important features in the below listed sections:

- ▶ DESCRIPTION
- ▶ COMPATIBLE DEVICES
- ▶ BOX CONTENTS
- ▶ FEATURES
- ▶ MODEL COMPARISON
- ▶ TYPICAL APPLICATION

### 1.1. Description

This transmitter family was designed to extend digital video signals (e.g. HDMI 1.4 and DP 1.1) and audio signals (analog stereo audio from local input or embedded 7.1 HBR audio). Video signals with HDCP encryption are also supported. Many combinations of the audio/video signals are available to transmit.

Using the factory, custom or transparent EDID emulation the user can fix and lock EDID data on each input connector. Advanced EDID Management forces the required resolution from any video source and fixes the output format conforming to the system requirements. The unit offers bi-directional and transparent IR, RS-232 and Ethernet transmission. Furthermore, the IR and RS-232 connection support command injection, allowing them to send any IR or RS-232 control command directly from the LAN connection.

PoE-compatible remote powering (Power over Ethernet) is available through a single CAT cable, but local power supply can also be used. The device can be mounted on a rack shelf or used standalone. HDMI-TPS-TX200 series is compatible with both the HDBaseT™ extenders and matrix switchers.

Advanced models contain an 8-pole Phoenix® connector with user-configurable General Purpose Input and Output pins. Using the built-in Event manager with the GPIO pins, many controlling functions can be established in a simple way.

#### Model Denomination

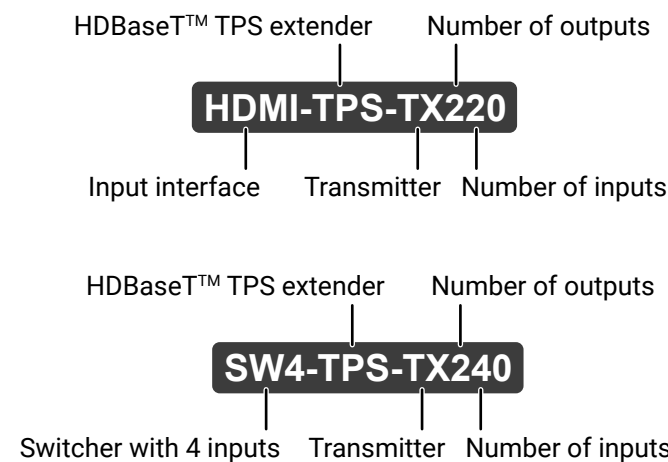

### 1.2. Compatible Devices

The transmitter is compatible with other Lightware TPS receivers, matrix TPS and TPS2 boards, 25G TPS2 boards, as well as third-party HDBaseT-extendors, displays, but not compatible with the phased out TPS-90 extendors.



The transmitter is compatible with any third-party HDBaseT™ device.

HDBaseT™ and the HDBaseT Alliance logo are trademarks of the HDBaseT Alliance.

### 1.3. Box Contents

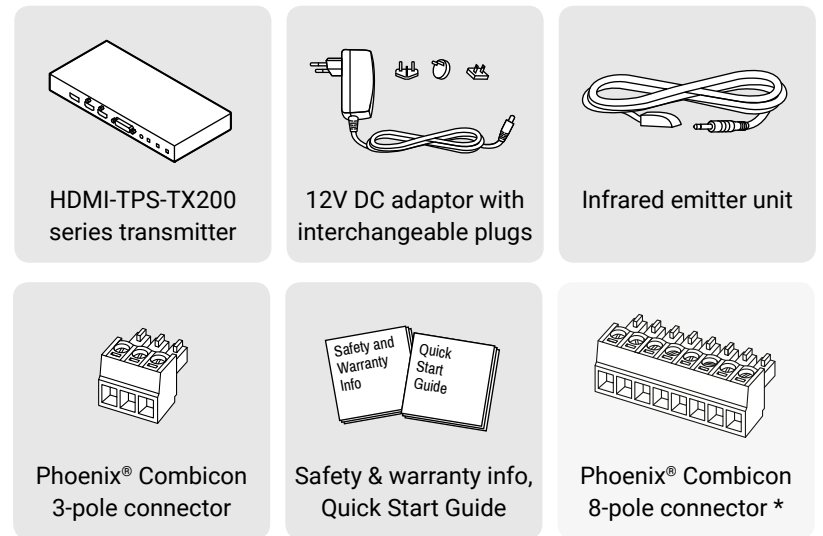

\* Only for the following models: HDMI-TPS-TX220, DP-TPS-TX220, DVI-HDCP-TPS-TX220, SW4-TPS-TX240.

### 1.4. Features



#### 3D and 4K Support

High bandwidth allows extension of resolutions up to 4K and even 3D sources and displays are supported.



#### Signal Transmission up to 170 m

Video and audio signal transmission (HDMI, Ethernet, RS-232, and Infra-Red over a single CAT5e...CAT7e cable).



#### Deep Color Support and Conversion

It is possible to transmit the highest quality 36-bit video streams for perfect color reproduction.



#### Pixel Accurate Reclocking

Each output has a clean, jitter free signal, eliminating signal instability and distortion caused by long cables or connector reflections.



#### HDCP-compliant

The receiver fulfills the HDCP standard. HDCP capability on the digital video inputs can be disabled when non-protected content is extended.



#### Built-in Event Manager

The Event Manager tool takes care of all the necessary control in a smaller configuration by performing predefined actions in response to device status changes. Hence, in a less complex environment, there is no need to invest in additional control solutions, which makes the receiver the best choice for numerous applications.



#### Autoselect Function for Video Inputs

The Autoselect feature can sense the port status on the video input ports and select automatically one of them. Priority number can be set for each input port and the feature allows to set various modes for the automatic input selection (First detect, Last detect, Priority mode).



#### Remote Power

The transmitters are PoE-compatible and can be powered locally by the supplied power adaptor, or remotely via the TPS connection (through the CATx cable) with a compatible power source equipment.



#### Bi-directional RS-232 Pass-through

AV systems can also contain serial port controllers and controlled devices. Serial port pass-through supports any unit that works with standard RS-232.



#### GPIO Control Port

7 GPIO pins operating at TTL digital signal levels and can be controlled with both LW2 and LW3 commands.

### 1.5. Model Comparison

The available models have different features depending on their design. The following table contains the most important differences between the models:

	Audio / Video ports						Audio port	Interface ports			
	HDMI input	DVI-D input	DP input	HDMI output	DVI-D output	TPS output	Jack 3.5 input	Ethernet	Infra	RS-232	GPIO
<b>HDMI-TPS-TX210</b>	✓	-	-	✓	-	✓	-	✓	✓	✓	-
<b>HDMI-TPS-TX220</b>	✓	-	-	✓	-	✓	✓	✓	✓	✓	✓
<b>DVI-HDCP-TPS-TX210</b>	-	✓	-	-	✓	✓	-	✓	✓	✓	-
<b>DVI-HDCP-TPS-TX220</b>	-	✓	-	-	✓	✓	✓	✓	✓	✓	✓
<b>DP-TPS-TX210</b>	-	-	✓	✓	-	✓	-	✓	✓	✓	-
<b>DP-TPS-TX220</b>	-	-	✓	✓	-	✓	✓	✓	✓	✓	✓
<b>SW4-TPS-TX240</b>	✓	✓	✓	✓	-	✓	✓	✓	✓	✓	✓

### 1.6. Typical Application

#### Standalone Application - HDMI-TPS-TX220

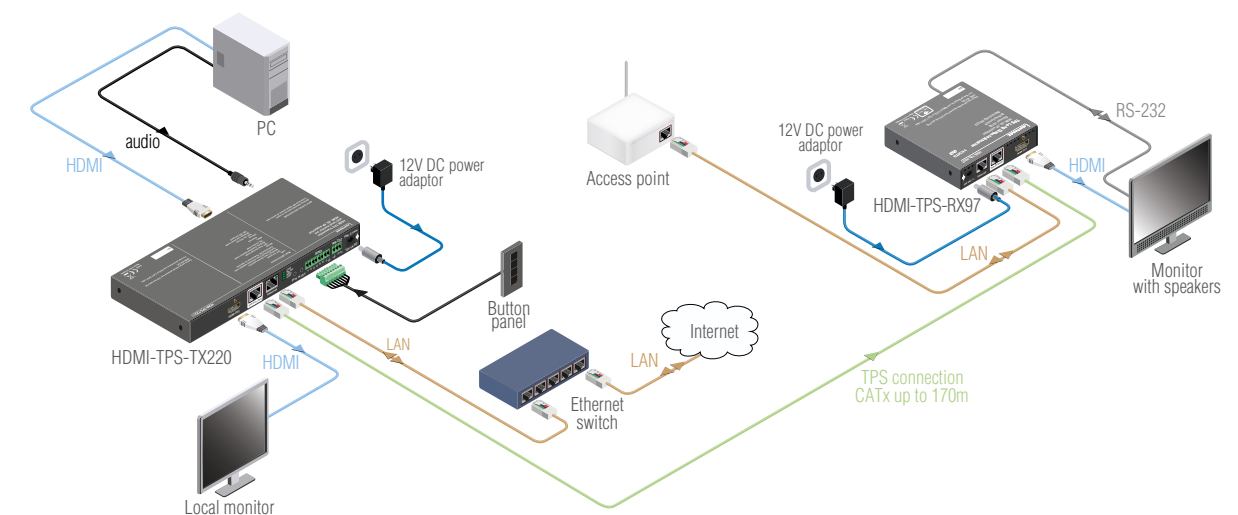

**Integrated System Diagram - DVI-HDCP-TPS-TX220**

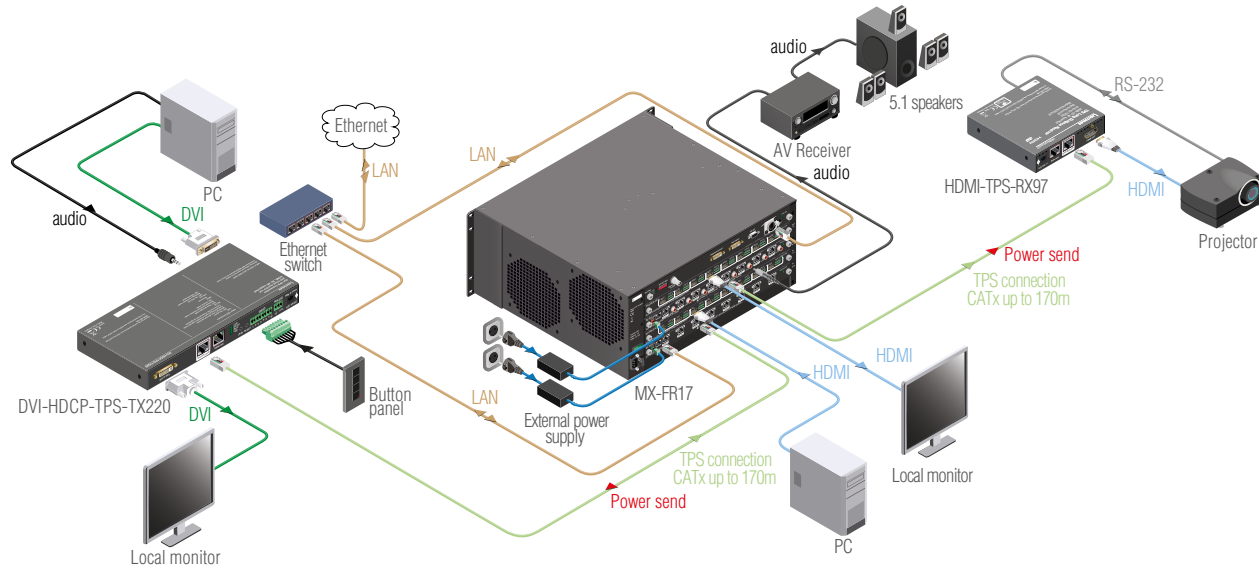

**Standalone Application - SW4-TPS-TX240**

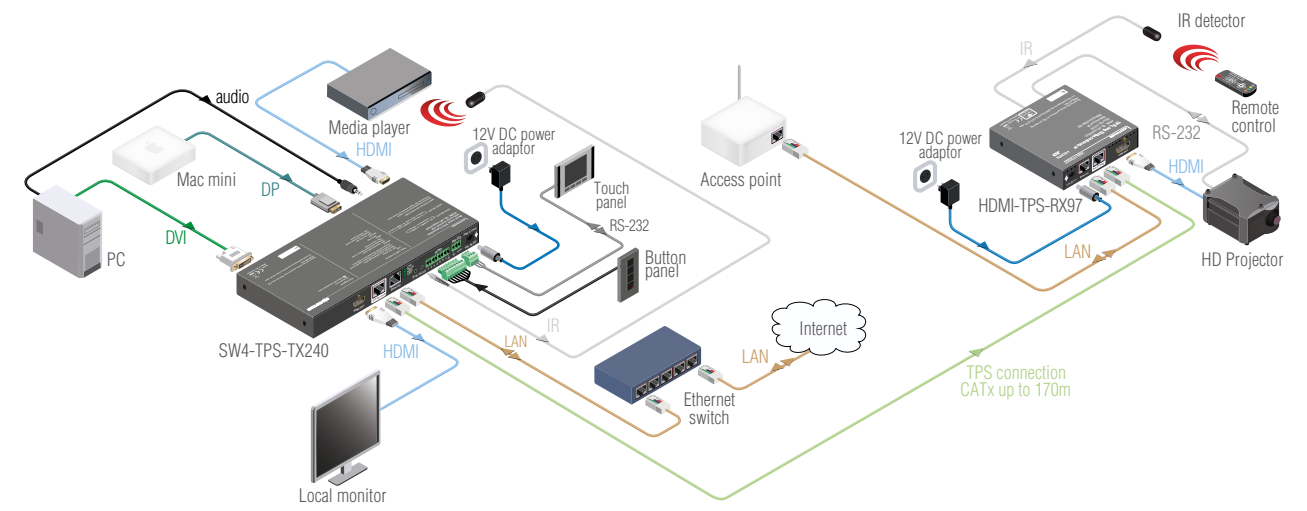

**Integrated System Diagram - DP-TPS-TX220**

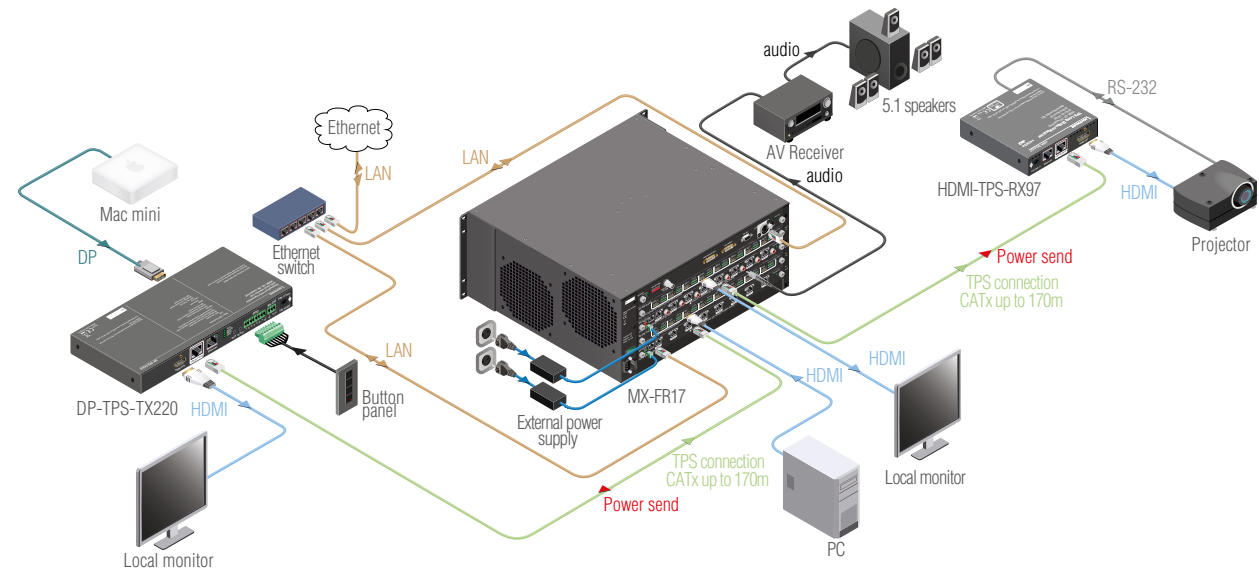

**Integrated System Diagram - SW4-TPS-TX240**

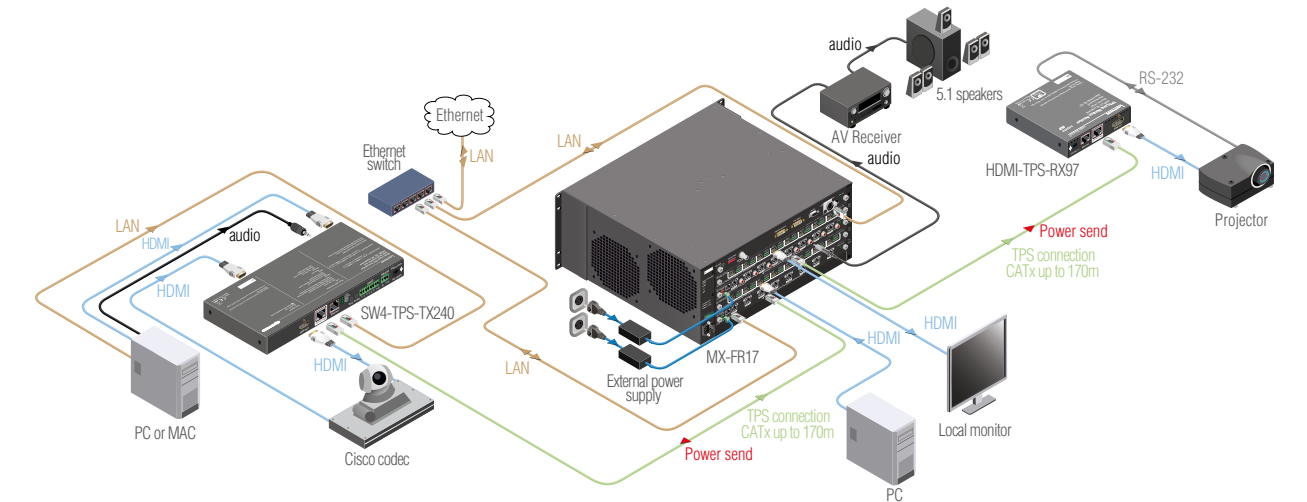



# 2

## Installation

The chapter is about the installation of the device and connecting to other appliances, presenting also the mounting options and further assembly steps

- ▶ MOUNTING OPTIONS
- ▶ CONNECTING STEPS
- ▶ POWERING OPTIONS

### 2.1. Mounting Options

To mount the transmitter Lightware supplies optional accessories for different usage. There are two kinds of mounting kits with similar fixing method. The device has two mounting holes with inner thread on the bottom side; see the bottom view in the [Mechanical Drawings](#) section. Fasten the device by the screws enclosed to the accessory:

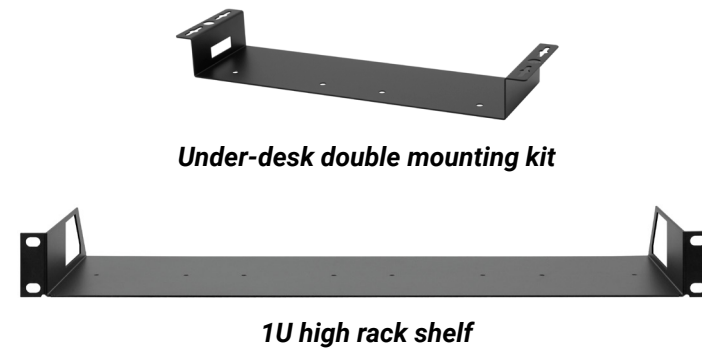

The Under-desk double mounting kit makes easy to mount a single device on any flat surface, e.g. furniture. 1U high rack shelf provides mounting holes for fastening two half-rack or four quarter-rack sized units. Pocket-sized devices can also be fastened on the shelf. To order mounting accessories please contact [sales@lightware.com](mailto:sales@lightware.com).

**WARNING!** Always use the supplied screws. Using different (e.g. longer) ones may cause damage to the device.

INFO: The transmitter is half-rack sized.

#### 2.1.1. 1U High Rack Shelf

Allows rack mounting for half-rack, quarter-rack and pocket sized units.

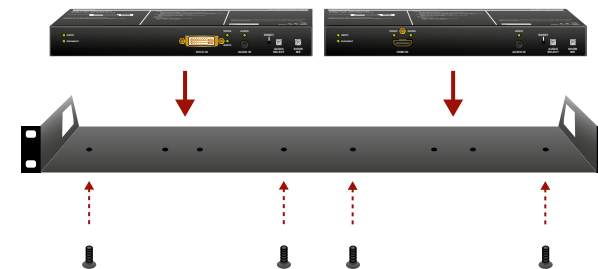

1U high rack shelf provides mounting holes for fastening two half-rack or four quarter-rack sized units. Pocket sized devices can also be fastened on the self.

#### 2.1.2. Under-desk Double Mounting Kit

The UD-kit double makes it easy to mount a single transmitter on any flat surface (e.g. furniture).

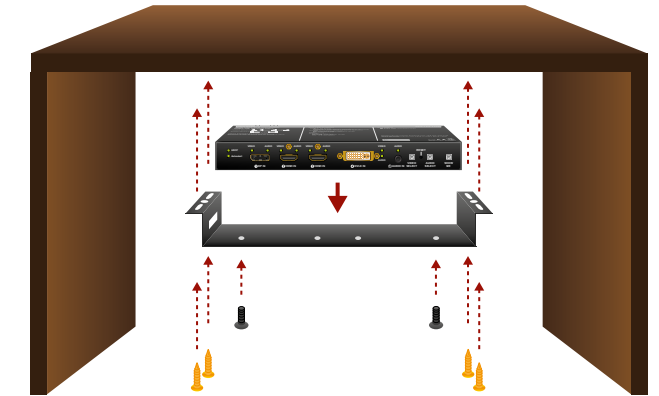

INFO: The chipboard screws are not supplied with the mounting kit.

## 2.2. Connecting Steps

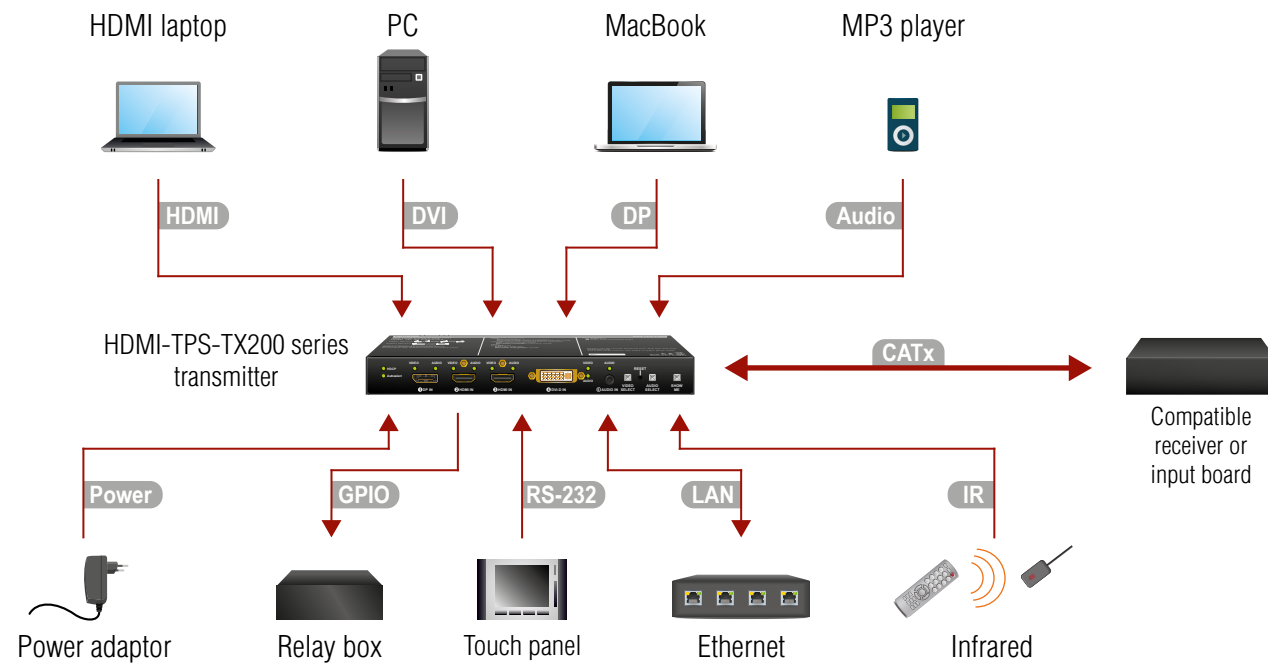

**CATx** Connect the the transmitter and a compatible receiver or the matrix input board by a CATx cable via the TPS connectors.

**DVI**  
**HDMI**  
**DP** Connect the transmitter and the sources using the inputs and DVI-I / HDMI / DisplayPort cables.

**Audio** Optionally connect an asymmetric audio device with unbalanced audio signal (e.g. a MP3 player) to the 2.5" TRS (Jack) audio input port.

**IR** Optionally for Infrared control:  
- Connect the IR emitter to the IR OUT port of the device.  
- Connect the IR detector to the IR IN port of the device.

**LAN** Optionally connect the transmitter to a LAN network in order to control the device.

**RS-232** Optionally for RS-232 control: connect a controller/controlled device (e.g. touch panel) to the RS-232 port.

**GPIO** Optionally connect a controller/controlled device (e.g. relay box) to the GPIO port.

**Power** See powering options in the next section.

## 2.3. Powering Options

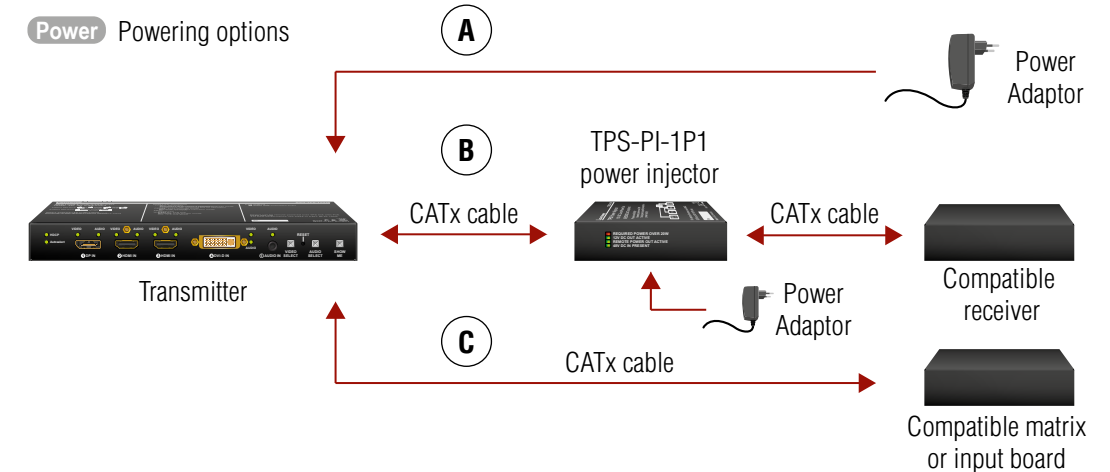

**A** **Using local PSU:** connect the power adaptor to the DC input on the transmitter first, then to the AC power socket.

**B** **Using PoE with connecting a transmitter:** connect the TPS OUT (PoE) port of the transmitter to the TPS+PoE port of the TPS-PI-1P1 power injector by a CATx cable, and connect the TPS input port of the compatible receiver to the TPS port of the TPS-PI-1P1 by a CATx cable.

**C** **Using PoE with connecting a matrix or an input board:** connect the TPS OUT (PoE) port of the transmitter to the PoE-compatible TPS input port of the matrix or input board by a CATx cable.

**ATTENTION!** In case of connecting the transmitter to an input board of the matrix always connect an external PSU to the board. For the detailed information please read the user's manual of the matrix.

**ATTENTION!** The Ethernet port does not support PoE. Only the TPS port support PoE function.

**INFO:** If both remote and local power sources are connected, the remote power will be used.



# 3

## Product Overview

The following sections are about the physical structure of the device, input/output ports and connectors:

- ▶ [FRONT VIEW](#)
- ▶ [REAR VIEW](#)
- ▶ [ELECTRICAL CONNECTIONS](#)
- ▶ [TPS EXTENDER CONCEPT](#)
- ▶ [PORT DIAGRAM](#)
- ▶ [TPS INTERFACE](#)
- ▶ [AUDIO INTERFACE](#)
- ▶ [VIDEO INTERFACE](#)
- ▶ [THE AUTOSELECT FEATURE](#)
- ▶ [CONTROL FEATURES](#)
- ▶ [FURTHER BUILT-IN FEATURES](#)

### 3.1. Front View

HDMI-TPS-TX210



HDMI-TPS-TX220



DVI-HDCP-TPS-TX210

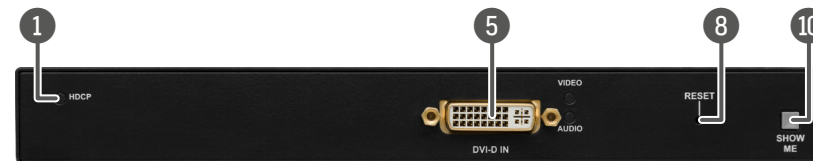

DVI-HDCP-TPS-TX220

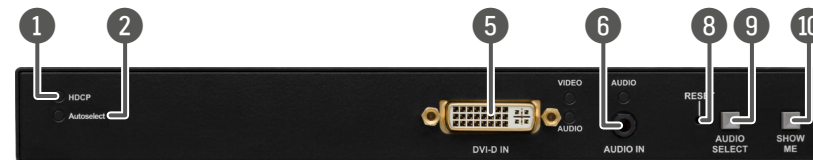

DP-TPS-TX210



DP-TPS-TX220



SW4-TPS-TX240



- |    |                            |  |
|----|----------------------------|--|
| 1  | <b>HDCP LED</b>            | LED gives feedback about the HDCP status of the output signal. See the details in the <a href="#">HDCP LED</a> section.  |
| 2  | <b>Autoselect LED</b>      | LED gives feedback about the current Autoselect status. See the details in the <a href="#">Autoselect LED</a> section. You can find more information about Autoselect feature in <a href="#">The Autoselect Feature</a> section. |
| 3  | <b>DisplayPort input</b>   | DisplayPort connector for DisplayPort audio/video signal.  |
| 4  | <b>HDMI input</b>          | HDMI connector for DVI video or HDMI video and audio.  |
| 5  | <b>DVI-D input</b>         | DVI-I connector for DVI-D video and audio.   |
| 6  | <b>Audio input</b>         | 3.5 mm Jack connector for asymmetric analog audio input signal.  |
| 7  | <b>Video Select button</b> | Button for switching between video sources. See the details in the <a href="#">Video Select Button</a> section.  |
| 8  | <b>Reset button</b>        | Pushing the button reboots the unit.   |
| 9  | <b>Audio Select button</b> | Button for switching between audio sources. See the details in the <a href="#">Audio Select Button</a> section.  |
| 10 | <b>Show Me button</b>      | Special functions can be reached using this button (firmware upgrade (bootload) mode, DHCP settings, restore factory default settings, condition launching in <a href="#">Event Manager</a> ).                                   |

### 3.2. Rear View

#### HDMI-TPS-TX210

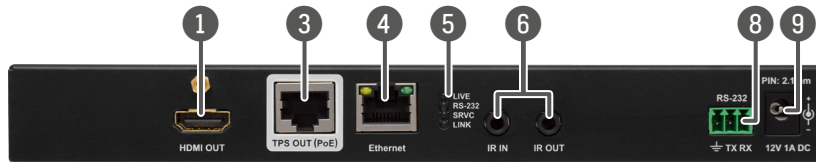

#### HDMI-TPS-TX220

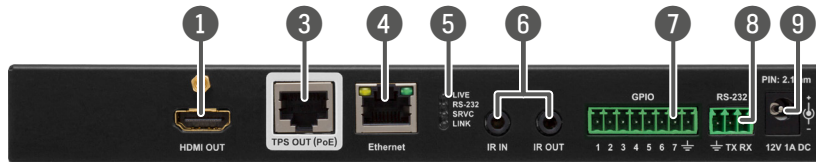

#### DVI-HDCP-TPS-TX210

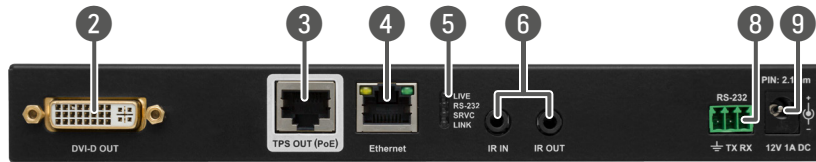

#### DVI-HDCP-TPS-TX220

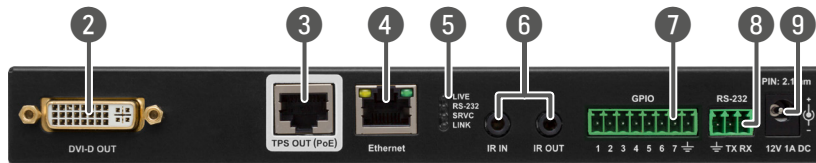

#### DP-TPS-TX210

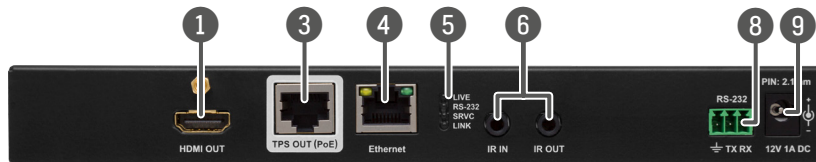

#### DP-TPS-TX220

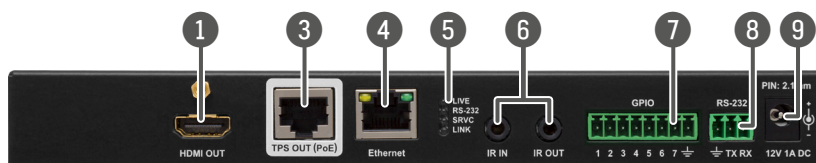

#### SW4-TPS-TX240

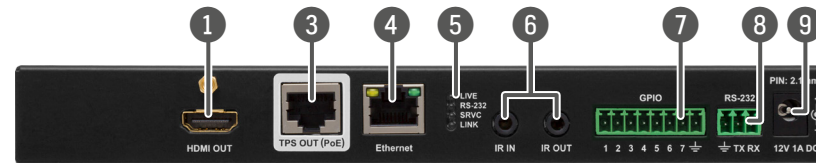

- 1 **HDMI output** Local HDMI output with the same A/V content as the TPS output.
- 2 **DVI-D output** Local DVI-D output with the same A/V content as the TPS output.
- 3 **TPS output** Locking RJ45 connector for HDBase™ signal transmission. Maximum CATx cable distances can be found in the [Maximum Extension Distances](#) section.
- 4 **Ethernet** Locking RJ-45 connector for configuring the device using Lightware Device Controller (LDC), or upgrading it using Lightware Device Updater (LDU). Any third-party control system can use this port to control the device.
- 5 **Status LEDs** The LEDs give feedback about the actual state of the device. See the details in the [Rear Panel Status LEDs](#) section.
- 6 **IR IN and OUT** 3-pole TRS connector, also known as 3.5 mm (1/8") jack plug for optional IR receiver (IR IN) and transmitter (IR OUT) connection. Pin assignments can be found in the [IR Connector](#) section.
- 7 **GPIO** 8-pole Phoenix connector for configurable general purpose input/output ports. Pin assignment can be found in the [GPIO - General Purpose Input/Output Ports](#) section.
- 8 **RS-232 connector** 3-pole Phoenix connector for controlling the device with LDC or third-party control systems, or third-party device control. Pin assignment can be found in the [RS-232 Connector](#) section.
- 9 **12V DC connector** 12V DC input for local powering. For more details see the [12V DC Connection](#) section or see all the available [Powering Options](#).

### 3.3. Electrical Connections

#### 3.3.1. DVI-I Connector

DVI-HDCP-TPS-TX210/TX220 and SW4-TPS-TX240 transmitters provide 29 pole „digital only” DVI-I Dual-Link connectors (only digital pins are internally connected) for input and local output. This way, users can plug in any DVI connector, but keep in mind that analog signals (such as VGA or RGBHV) are not processed.

Always use high quality DVI cable for connecting sources and displays.

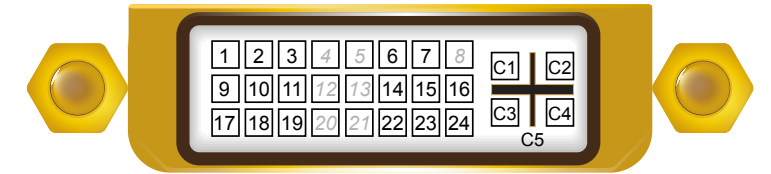

Pin	Signal	Pin	Signal
1	TMDS Data2-	16	Hot Plug Detect
2	TMDS Data2+	17	TMDS Data0-
3	TMDS Data2 Shield	18	TMDS Data0+
4	Not connected	19	TMDS Data0 Shield
5	Not connected	20	Not connected
6	DDC Clock	21	Not connected
7	DDC Data	22	TMDS Clock Shield
8	Not connected	23	TMDS Clock+
9	TMDS Data1-	24	TMDS Clock-
10	TMDS Data1+	C1	Not connected
11	TMDS Data1 Shield	C2	Not connected
12	Not connected	C3	Not connected
13	Not connected	C4	Not connected
14	+5V Power	C5	GND
15	GND (for +5V)		

#### 3.3.2. HDMI Connector

The extender provides standard 19 pole HDMI connector for input and local output. Always use high quality HDMI cable for connecting sources and displays.



### 3.3.3. DisplayPort Connector

DP-TPS-TX210/TX220 and SW-TPS-TX240 models provide standard 20-pole DisplayPort connector for input. Always use high quality DP cable for connecting DisplayPort devices.

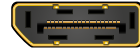

### 3.3.4. Ethernet Connector (TPS and LAN Ports)

The extender provides standard RJ45 connectors for TPS IN and LAN ports. Always use high quality Ethernet cable for connecting transmitters and receivers. Maximum CATx cable distances can be found in the [Maximum Extension Distances](#) section.

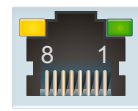

LAN connector

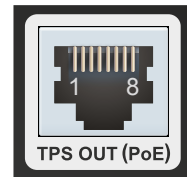

TPS connector

#### Wiring of TPS and LAN Cables

Lightware recommends the termination of LAN cables on the basis of TIA/EIA T 568 A or TIA/EIA T 568 B standards.

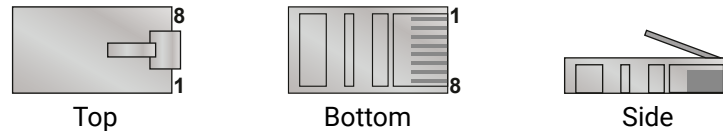

Pin	TIA/EIA T568 A	Color and name	TIA/EIA T568 B	Color and name
1		white/green stripe		white/orange stripe
2		green solid		orange solid
3		white/orange stripe		white/green stripe
4		blue solid		blue solid
5		white/blue stripe		white/blue stripe
6		orange solid		green solid
7		white/brown stripe		white/brown stripe
8		brown solid		brown solid

Pin assignments of RJ45 connector types

You can find more information about TPS interface in the [TPS Interface](#) section.

### 3.3.5. 12V DC Connection

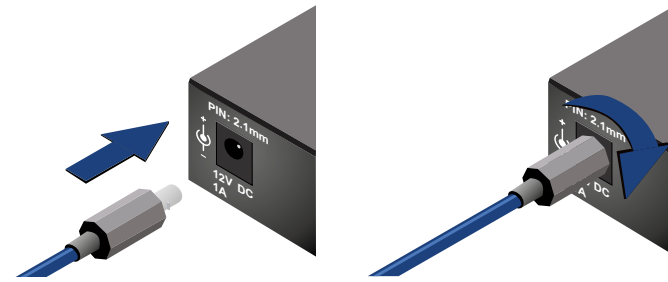

Locking DC connector

The transmitters are built with locking 12V DC connector. Do not forget to turn the plug clockwise direction before disconnecting the power adaptor.

**WARNING!** Always use the supplied 12V power adaptor. Warranty void if damage occurs due to use of a different power source.

### 3.3.6. Analog Stereo Audio

The connector is used for receiving unbalanced analog audio signal. It is also known as (3.5 mm or approx. 1/8") audio jack, phone jack, phone plug and mini-jack plug.

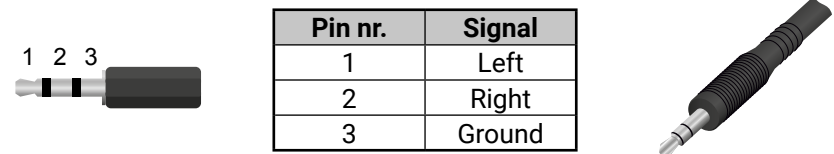

Jack audio plug pin assignments

Pin nr.	Signal
1	Left
2	Right
3	Ground

You can find more information about audio functions in the [Audio Interface](#) section.

### 3.3.7. RS-232 Connector

The extender contains a 3-pole Phoenix connector which is used for RS-232 serial connection.

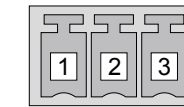

Pin nr.	Signal
1	Ground
2	TX data
3	RX data

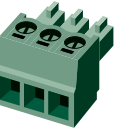

RS-232 connector pin assignments

#### Compatible Plug Type

Phoenix® Combicon series (3.5mm pitch, 3-pole), type: MC 1.5/3-ST-3.5.

You can find more information about RS-232 interface in the [Serial Interface](#) section.

### 3.3.8. IR Connector

IR detector and IR emitter can be connected to the HDMI-TPS-TX100 series extenders with TRS (Tip, Ring, and Sleeve) connectors. They are also known as (3,5 mm or approx. 1/8") audio jack, phone jack, phone plug, and mini-jack plug. The pin assignments are the following for the detector and the emitter:

Detector – 3-pole-TRS		Emitter – 2-pole-TS	
1 Tip	IR Input -	1 Tip	IR Output +
2 Ring	GND	2 Ring	IR Output -
3 Sleeve	IR Input +	3 Sleeve	IR Output -

**INFO:** Ring pole of the emitter is optional. If your IR emitter has three pole-TRS plug, then the Ring and the Sleeve are the same signal (Output -).

You can find more information about Infrared interface in the [IR Interface](#) section.

### 3.3.9. GPIO - General Purpose Input/Output Ports

The TPS-TX220 series and the SW4-TPS-TX240 transmitters contain a 8-pole Phoenix connector with seven GPIO pins, which operates at TTL digital signal levels and can be set to high or low level (Push-Pull). The direction of the pins can be input or output (adjustable). Voltage ranges for GPIO inputs are the following:



	Input voltage [V]	Max. current [mA]
<b>Logical low level</b>	0 - 0,8	30
<b>Logical high level</b>	2 - 5	18

INFO: The maximum total current for the seven GPIO pins is 180 mA.

Pin nr.	Level and direction
1	Configurable
2	
3	
4	
5	
6	
7	
Ground	

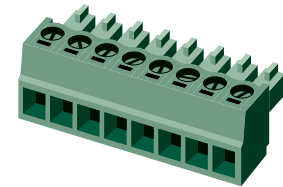
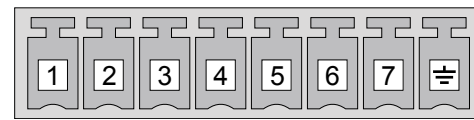

GPIO connector and plug pin assignments

#### Compatible plug type

Phoenix® Combicon series (3.5mm pitch 8-pole), type: MC 1.5/8-ST-3.5.

You can find more information about GPIO interface in the [GPIO Interface](#) section.

### 3.4. TPS Extender Concept

The HDMI-TPS-TX200 series transmitters are able to receive digital (DP, HDMI, DVI-D) video signals and analog audio signal as well and transmit HDBaseT (TPS) signal including HDMI/DVI audio/video signals, Ethernet, RS-232, and Infrared signals. Analog audio signals can be received via the 3.5" TRS (jack).

The device can be controlled via Ethernet, RS-232 or Infrared and is able to control third-party devices via the RS-232, Ethernet, Infrared interfaces.

### INPUT

- HDMI 1 →
- DP 2 →
- DVI-D 3 →
- Analog audio 4 →



### OUTPUT

- TPS {
  - HDMI / DVI
  - Ethernet
  - RS-232
  - Infrared
  - HDMI / DVI

- + Ethernet
- + RS-232
- + Infrared
- + GPIO 4

#### The summary of the interfaces

- <sup>1</sup> Only for HDMI-TPS-TX210/TX220 and SW4-TPS-TX240 models.
- <sup>2</sup> Only for DP-TPS-TX210/TX220 and SW4-TPS-TX240 models.
- <sup>3</sup> Only for DVI-HDCP-TPS-TX210/TX220 and SW4-TPS-TX240 models.
- <sup>4</sup> Only for TPS-TX220 and SW4-TPS-TX240 models.

### 3.5. Port Diagram

The following diagram introduces the route of the different signal types (including the audio/ video and control signals as well) from the input to the output ports in the device.

The diagram is about the SW4-TPS-TX240 transmitter. The principle of the operation is the same for all models.

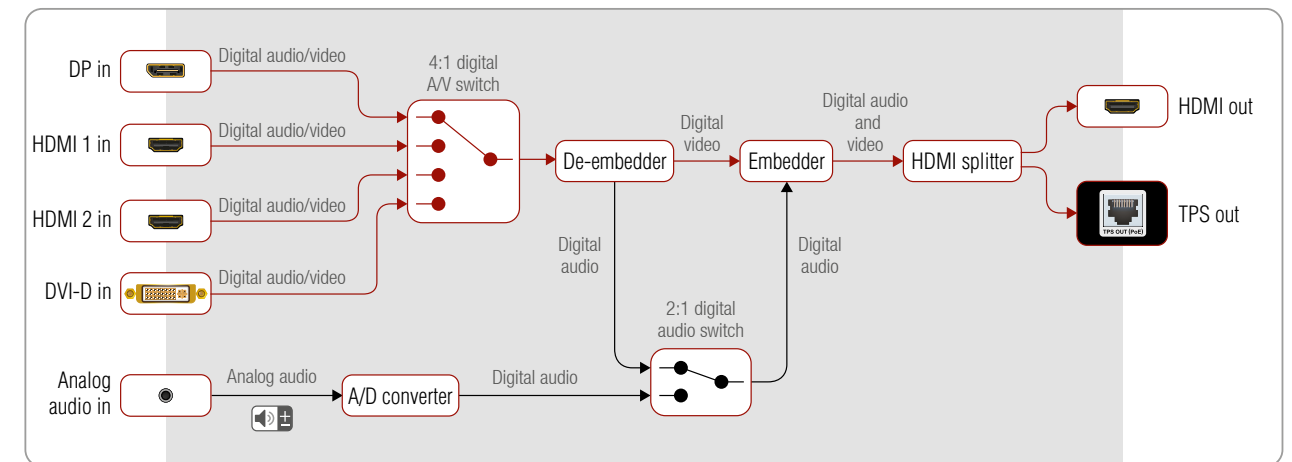

Port diagram of SW4-TPS-TX240 transmitter



### 3.6. TPS Interface

The device is built with TPS (Twisted Pair Single) interface which are using HDBaseT™ technology. It means the unit transmits video, audio, Ethernet, RS-232, and Infrared signals via a single CATx cable.

#### TPS Interface Working Modes

The TPS working mode between the transmitter and the receiver is determined by the mode set in them. Both devices TPS mode settings together determine the finally established TPS transmission mode.

The following TPS modes are defined in the transmitter:

- **Auto:** The TPS mode is determined automatically.
- **HDBaseT:** Ideal for high resolution signals up to 4K.
- **Long reach:** Ideal for big distances up to 1080p@60Hz with extended cable lengths.
- **LPPF1\*:** Only RS-232 communication is transmitted (@ 9600 baud).
- **LPPF2\*:** Only RS-232 (@ 9600 baud) and Ethernet communication are transmitted.

\* LPPF: Low Power Partial Functionality.

		Selected mode on RX side				
		LPPF1	LPPF2	HDBaseT	Long reach	Auto
Selected mode on TX side	LPPF1	LPPF1	LPPF1	LPPF1	LPPF1	LPPF1
	LPPF2	LPPF1	LPPF2	LPPF2	LPPF2	LPPF2
	HDBaseT	LPPF1	LPPF2	HDBaseT	Long reach	HDBaseT
	Long reach	LPPF1	LPPF2	Long reach	Long reach	Long reach
	Auto	LPPF1	LPPF2	HDBaseT	Long reach	HDBaseT **

\*\* If there is valid HDMI/DVI signal is on the TX side, the TPS mode will be HDBaseT on both side. If the transmitter does not transmits HDMI/DVI signal, the TPS mode will be changed to LPPF2 or LPPF1 automatically. Long reach mode is not available when both sides are set to Auto mode.

When using automatic operation mode selection, the device determines the mode of operation. If both halves are set to Auto mode, the source side is the initiator. It will negotiate each state transition with its sink side partner.

When one of the devices is configured to manual operation mode selection, the other device may be placed in automatic mode. In this case, the mode transition negotiation is initiated by the host-managed device and the auto-mode device follows through. The allowed cable lengths and resolutions are listed in the [Maximum Extension Distances](#) section.

### 3.7. Audio Interface

#### 3.7.1. Audio Input Modes

The device can receive embedded digital audio signal on the HDMI, DisplayPort, and DVI-D input ports and analog audio signal on the Jack input ports.

##### Audio Embedding

The transmitter has a built-in audio embedder function which means the audio signal being received on the analog audio input port can be embedded to the TPS output.

#### 3.7.2. Audio Options - Example

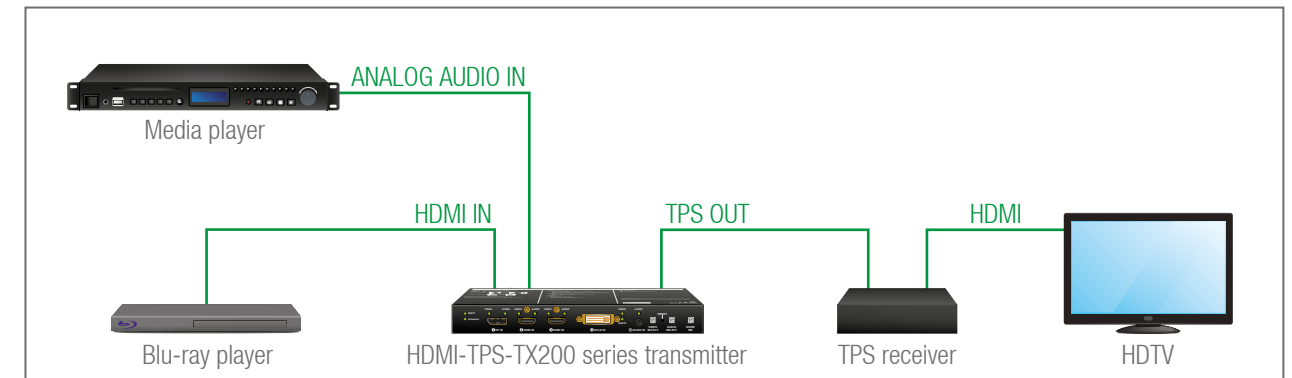

##### The Concept

Two audio sources are connected to the transmitter: a Blu-ray player on the HDMI input (embedded HDMI audio); and a Media player on the analog audio input (Jack). The transmitter is connected to a TPS receiver which transmits the A/V signal to a HDTV.

The following options are available for audio routing / signal selection:

The video input source of the **HDTV** is the **Blu-ray player**, you can select from the following audio sources:

- the original embedded HDMI audio from the **Blu-ray player**;
- the analog audio input from the **Media player**.

**INFO:** In case of the TPS-TX220 series transmitters you can use the Autoselect feature for audio input selection. For the details see [The Autoselect Feature](#) section.

### 3.8. Video Interface

#### 3.8.1. Video Input Modes

The device can receive digital video signal on the HDMI, DisplayPort, and DVI-D input ports.

#### 3.8.2. Input Source Selection Modes

Video input source can be selected the following ways:

- pressing **Video Select** button on the device;
- using Lightware Device Controller (LDC);
- sending LW2 or LW3 protocol commands; or
- using the **Autoselect** function.

### 3.9. The Autoselect Feature

There are three types of Autoselect as follows.

- **First detect mode:** selected input port is kept connected to the output as long as it has an active signal.
- **Priority detect mode:** always the highest priority active input is selected to transmit.
- **Last detect mode:** always the last attached input is selected to transmit.

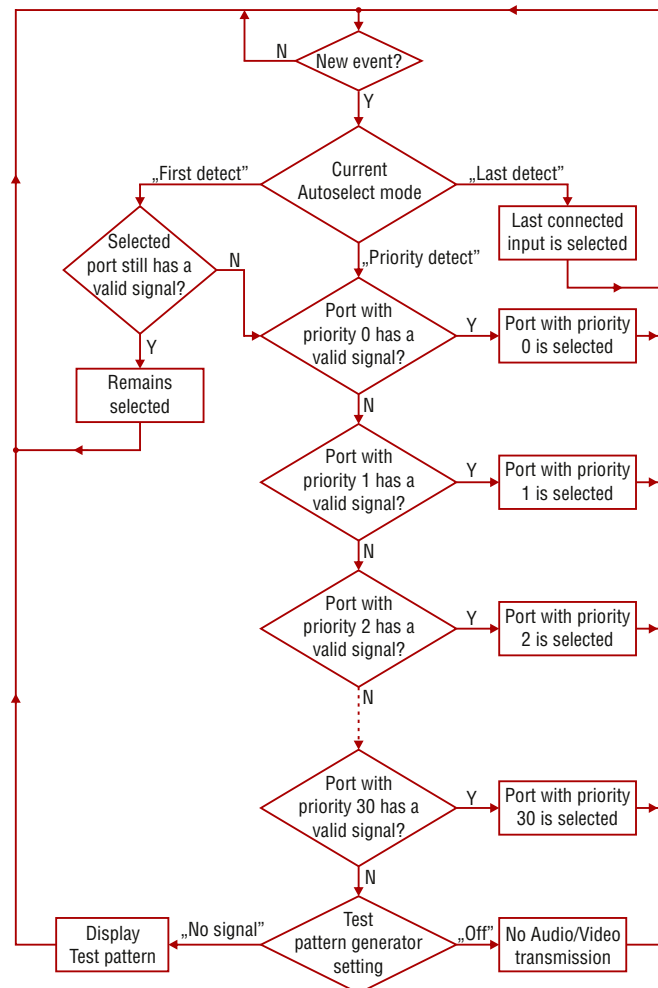

Flowchart of Autoselect modes

#### Automatic Input Selection - Example

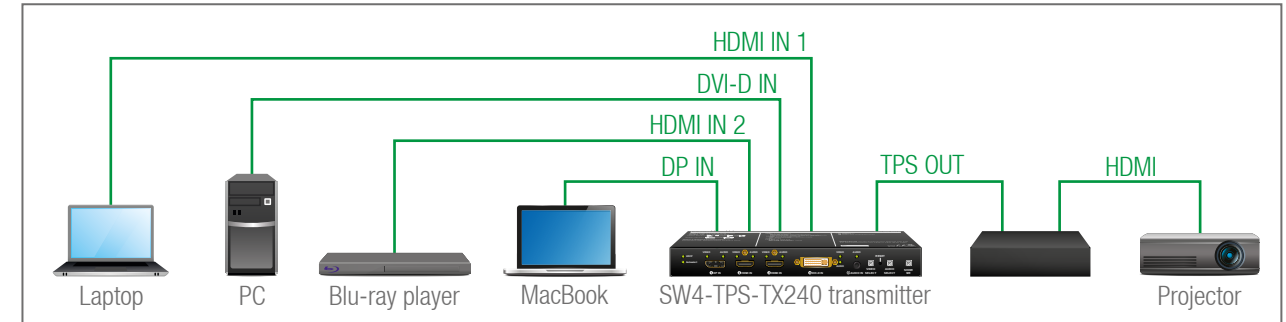

#### The Concept

If there is no other source connected to the transmitter, but the Laptop, HDMI 1 input will be automatically switched to the TPS output. If the Laptop and the PC are also connected to the transmitter, DVI-D input will be switched to the TPS output. If the Blu-ray player is connected on the HDMI 2 input, and later the MacBook is connected on the DP input of the transmitter, it will be switched to the TPS output – independently of the presence of other video signals.

#### Settings

- **TPS output:** Set the Autoselect to **Enabled**. Set Autoselect mode to **Priority detect**. The priorities are the following (the lowest number means the highest priority):

Source device	Input interface	Input port	Priority
MacBook	DP IN	I1	0
Blu-ray player	HDMI IN 1	I2	1
PC	DVI-D IN	I4	2
Laptop	HDMI IN 2	I3	3

INFO: Priorities can be set in Lightware Device Controller software, see related settings in the [Video Outputs \(TPS and HDMI\)](#) sections.

## 3.10. Control Features

### 3.10.1. Serial Interface

#### Technical Background

Serial data communication can be established via the local RS-232 port (Phoenix connector) or via the TPS lines. The RS-232 ports – which are connected to the CPU – can be configured separately (e.g. if the Baud rates are different, the CPU does the conversion automatically between the ports). The RS-232 port can be switched to Pass-through mode, Control mode, or Command Injection mode; see the figure below.

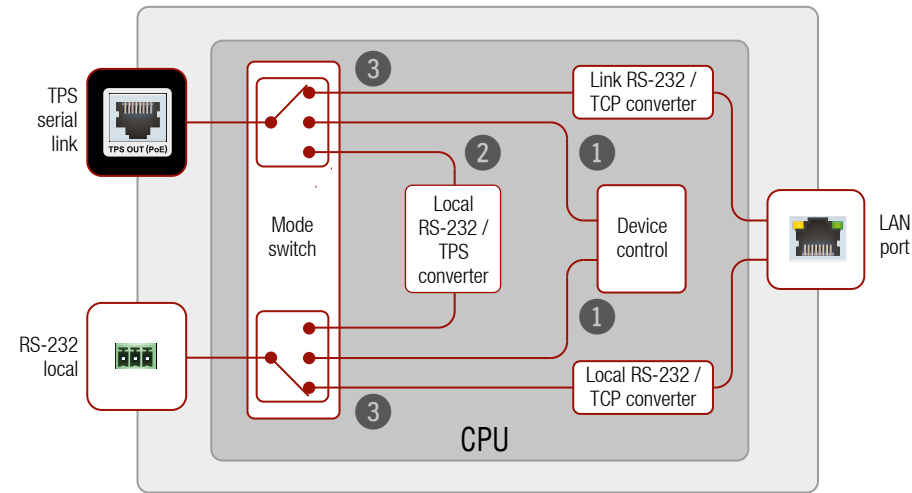

**Block diagram of the serial interface**

The following settings are defined:

- ① The Local and the TPS serial ports are in **Control mode**.
- ② The Local and the TPS serial ports are in **Pass-through mode**.
- ③ The Local and the TPS serial ports are in **Command Injection mode**.

INFO: All settings are available in the LDC software, see settings in the [RS-232](#) section.

Only one mode can be used at the same time: Control mode, or Pass-through mode, or Command Injection mode. If you choose one of them, TPS serial link and local RS-232 port will operate in the same mode.

#### Pass-through Mode

In pass-through mode, the given device forwards the data that is coming from one of its ports to another same type of port. The command is not processed by the CPU. Incoming serial data is forwarded from local RS-232 port to the TPS output port and vice versa inside the transmitter.

#### Control Mode

The incoming data from the given port is processed and interpreted by the CPU. The mode allows to control the transmitter directly. LW2 or LW3 protocol commands are accepted – depending on the current port setting.

#### Command Injection Mode

In this mode, the transmitter works as an RS-232 bidirectional converter. The TPS signal is converted to RS-232 data and vice versa. TCP/IP port numbers are defined for the serial ports (TPS and local) for this purpose. E.g. the default Command Injection port number of the local RS-232 port is 8001. If a command is coming from the TPS interface which addresses to the port no. 8001, it will be transmitted to the Tx pin of the local RS-232 port. That works in the opposite direction of course and the method is the same on the serial interface of the TPS port as well.

#### RS-232 Signal Transmission – Example

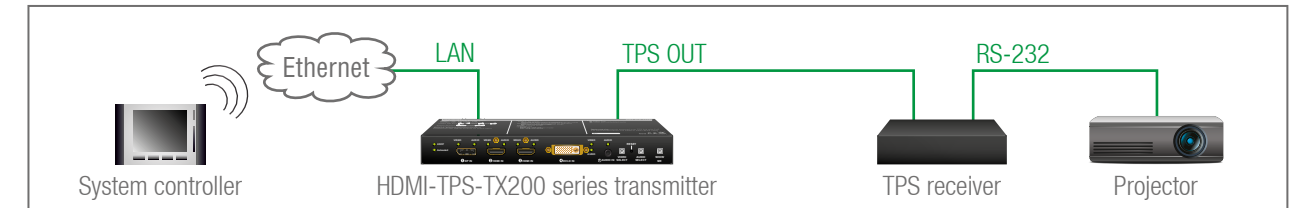

#### The Concept

The System controller can send commands to the transmitter and it is able to remote control the projector through the TPS receiver via RS-232.

#### Settings

- **System controller:** wireless IP connection to the same Ethernet as the transmitter is connected to. Use a dedicated software tool (e.g. a terminal) which is suitable for sending commands via TCP/IP to a certain IP:port address.
- **Transmitter:** set the RS-232 mode to Command Injection on TPS output port. Set the further parameters (Baud rate, Data bits, etc.) in accordance with the specifications of the projector. The transmitter will transmit the RS-232 data toward the receiver.
- **Receiver:** set the RS-232 mode to Pass-through on RS-232 port.
- **Projector:** note the RS-232 port setting that is specified by the Manufacturer. Connect a suitable serial cable with the proper wiring.



### 3.10.2. IR Interface

**ATTENTION!** For the complete usage attach an IR emitter unit to the IR OUT and an IR detector unit to the IR IN connectors.

#### Technical Background

The Infrared signal transmission is similar to the serial data communication. The transmitter contains dedicated IR I/O connection and also can transmit/receive IR signal via the TPS interface. The signal is in pronto HEX format in both cases.

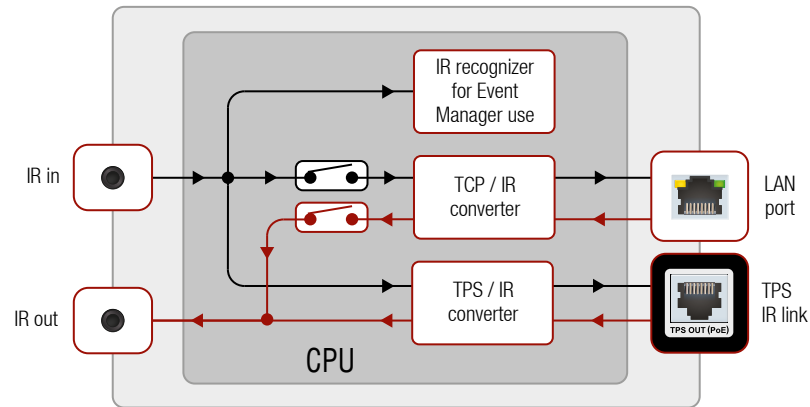

**Block diagram of the IR interface**

The most trivial usage of the IR interface is the transparent mode: signal received or sent on local IR ports are transmitted directly on the TPS IR link port and vice versa. Beside of this there is an IR recognizer in the device where you can assign actions in Event Manager for. The third option is the command injection mode (like at serial interface in the previous section) where you can send IR commands over LAN. Command injection mode can be turned on and off by input/output ports.

**INFO:** All settings are available in the LDC software, see settings in the [Infra](#) section.

**INFO:** The modulation of output IR signal can be turned off or on by LW3 command, see details in the [Enable/Disable Output Signal Modulation](#) section.

### IR Signal Transmission - Example 1

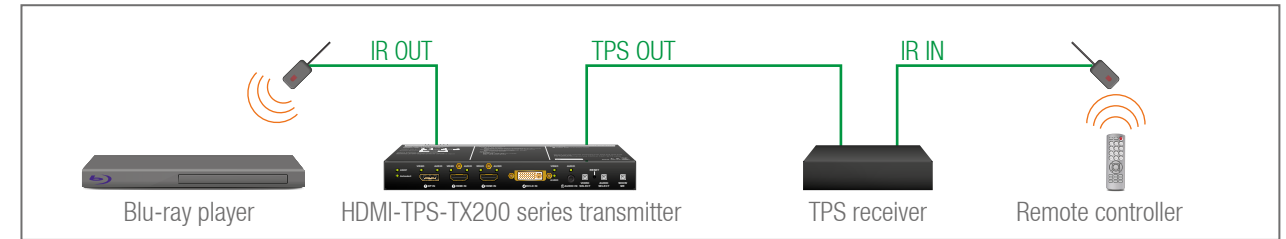

#### The Concept

An IR detector is attached to the Infrared input port of the TPS receiver and IR signals are sent by the Remote controller. The TPS Receiver is connected to a HDMI-TPS-TX200 series transmitter built with IR output port via TPS line.

#### Settings:

Set the TPS IR link of the Transmitter to **Transparent mode**. IR signals are received over the local IR input port of the **Receiver** by the Remote controller. The signals transmitted further over the TPS line to the **Transmitter** which can control the **Blu-ray player** via an IR emitter.

### 3.10.3. Ethernet Control Interface

The device can be controlled over front panel Ethernet standard RJ45 connector which connected to LAN. This interface supports both LW2 and LW3 protocols.

The interface can be used to remote control the device with Lightware Device Controller and establish the connection to Lightware Device Updater software and perform firmware upgrade.

### 3.10.4. GPIO Interface

The GPIO (General Purpose Input/Output) port is a multifunctional input/output interface to control the transmitter or third-party devices and peripherals. You can establish connection between the controller/controllable device and the transmitter by the 8-pole Phoenix connector. Seven pin's direction is configurable independently based on needs of the application.

#### GPIO Options - Example

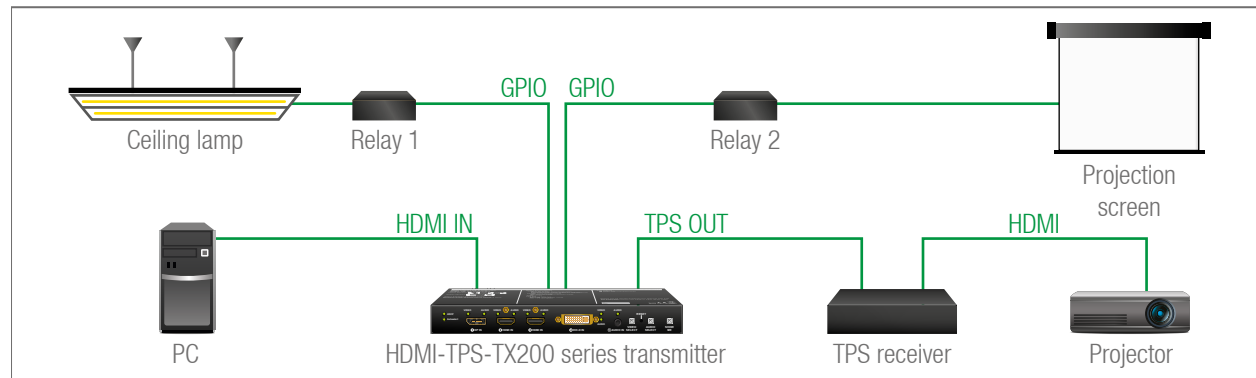

#### The Concept

Ceiling lamp is turned off by Relay 1 and projection screen is rolled down by Relay 2 when signal received from the PC over the VGA input. Both relays are controlled by the GPIO port.

#### Settings of the Transmitter

- **For Relay 1:** create an event in Event manager: when signal is present on Input 1 (I1) then set GPIO pins to low level for Relay 1 opening. Also create another event when signal is not present on Input 1 (I1) then set GPIO pins to high level for Relay 1 closing.
- **For Relay 2:** create an event in Event manager when signal is present on Input 1 (I1) then set GPIO pins to high level for Relay 2 closing. Also create another event when signal is not present on Input 1 (I1) then set GPIO pins to low level for Relay 2 opening.

When the PC starts to play the video presentation, the signal is received over the VGA input so GPIO pins send signal to Relay 1 to open which results turning off the lights. Furthermore GPIO pins also send signal to Relay 2 to close and the projection screen is rolled down. When the presentation is ended, signal ceases on the VGA input, so GPIO pins send signal to Relay 1 to close which results turning on the lights and sends signal to Relay 2 to open so projection screen returns to its enclosure.

**ATTENTION!** Please always check the electrical parameters of the devices what you want to control. The maximum current of one GPIO pin is 30 mA, the maximum total current for the seven pins is 180 mA.

See the LDC settings for GPIO port in the [GPIO](#) section. See also the details about the Event Manager settings in the [Event Manager](#) section.

### 3.11. Further Built-in Features

#### 3.11.1. Automatically Launched Actions – The Event Manager

The Event Manager feature means that the device can sense changes on its ports and is able to react according to the pre-defined settings. Lightware Device Controller contains a user-friendly software tool and allows to create Events by defining a Condition and an Action.

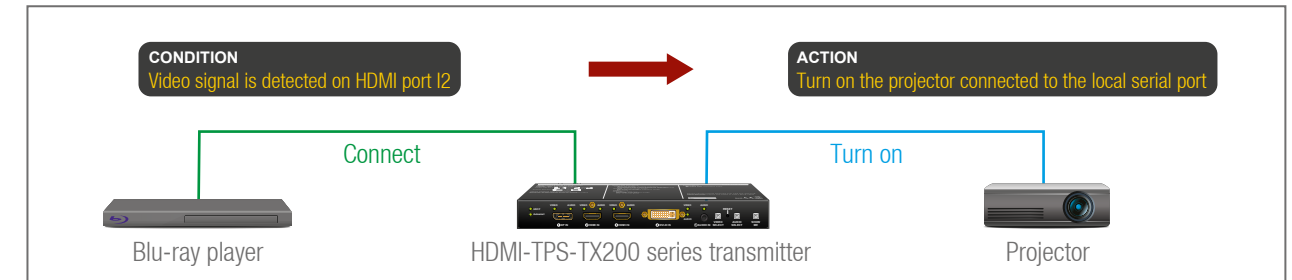

*Event Manager example*

See more information about the settings in the [Event Manager](#) section.

#### 3.11.2. Transmitter Cloning – Configuration Backup and Restore

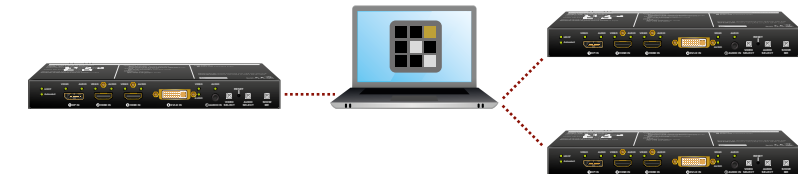

The transmitter (configuration) cloning of a HDMI-TPS-TX200 series transmitter is a simple method that eliminates the need to repeatedly configure certain devices to have identical (non-factory) settings. If the devices are installed in the same type of system multiple times then it is enough to set up only one device to fit the user's needs and then copy those settings to the others, thus saving time and resources.

See more information about the settings in the [Configuration Cloning \(Backup Tab\)](#) section.

#### 3.11.3. Remote Firmware Upgrade of Connected Lightware Devices



The firmware of the Lightware TPS devices can be upgraded individually by Lightware Device Updater (LDU) software. HDMI-TPS-TX200 series transmitters contain a feature which allows having a faster and more comfortable firmware upgrade process. When the firmware of the connected extenders has to be upgraded the TPS connection is necessary towards the extenders – nothing else. The LDU will find the connected devices and can upgrade them.

The upgrade process is almost the same as in the case of the usual upgrade process. See the details of the process in the [Remote Firmware Upgrade of Connected Lightware Devices](#) section.

# 4

## Operation

This chapter is about the powering and operating of the device describing the functions which are available by the front/rear controls:

- ▶ FRONT PANEL LEDs
- ▶ FRONT PANEL BUTTONS
- ▶ SPECIAL FUNCTIONS
- ▶ REAR PANEL STATUS LEDs
- ▶ SOFTWARE CONTROL MODES

### 4.1. Front Panel LEDs

#### 4.1.1. Video Input LEDs



- OFF:** The video source is not selected.
- BLINKING:** The video source is selected but signal is not detected.
- ON:** The video source is selected and signal is detected.

#### 4.1.2. Audio Input LEDs



- OFF:** The audio source is not selected.
- BLINKING:** The audio source is selected but no signal is detected, regardless of the output mode (e.g. DVI EDID is emulated on the port with HDMI signal).
- ON (with short pause):** Audio source is selected, the audio is embedded to the output video stream.
- ON (continuously):** Audio source is selected, the port is active but audio is not embedded in the video stream (e.g. the output mode is DVI).

#### 4.1.3. HDCP LED



- OFF:** Video output signal is not encrypted with HDCP.
- ON:** Video output signal is encrypted with HDCP.

#### 4.1.4. Autoselect LED



- OFF:** Autoselect function is disabled.
- BLINKING:** Autoselect function is enabled, searching for signal (the video input LEDs are also blinking).
- ON:** Autoselect function is enabled, the active video signal is found (the selected video input's LED is also ON).

### 4.2. Front Panel Buttons

#### 4.2.1. Video Select Button



Only for SW4-TPS-TX240 model: desired video input can be selected by the **Video Select button** from the front panel. The selection order of the inputs is the following:

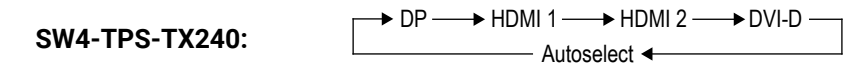

#### 4.2.2. Audio Select Button



Desired audio input can be selected by the **Audio Select button** from the front panel. The selection order of the inputs depends on the model as follows:

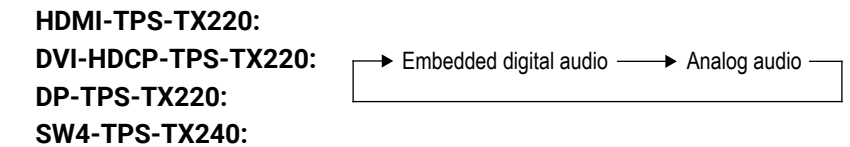

### 4.2.3. Programmable Show Me Button



Action or an operation can be assigned to the Show Me button. “**Show Me button pressed**” is a condition that can be selected in the Event Manager. See more details in the [Event Manager](#) section.

## 4.3. Special Functions

### 4.3.1. Enable DHCP (Dynamic) IP Address



The device has a static IP address as a factory default setting. If this setting does not fit to the circumstances during install or usage, DHCP can be enabled from the front panel:

- Step 1.** Make sure the device is powered on and operational.
- Step 2.** Press and keep pressed the **Show Me** button for 5 seconds.
- Step 3.** After 5 seconds front panel LEDs start blinking; release the button and press it 3 times again quickly (within 3 seconds).
- Step 4.** The LEDs get dark, DHCP gets enabled.

### 4.3.2. Reset to Factory Default Settings

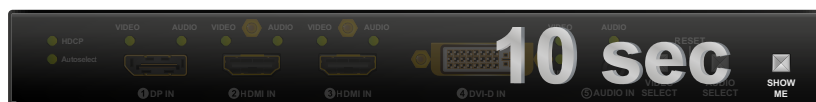

To restore factory default values, do the following steps:

- Step 1.** Make sure the device is powered on and operational.
- Step 2.** Press and keep pressed the **Show Me** button for 10 seconds. After 5 seconds front panel LEDs start blinking but keep on pressing the button.
- Step 3.** After 10 seconds the LEDs start blinking faster; release the button and press it 3 times again quickly (within 3 seconds).
- Step 4.** The LEDs get dark, the device restores the factory default settings and reboots.

Factory default settings are listed in the [Factory Default Settings](#) section.

### 4.3.3. Resetting the Device



In few cases (after firmware upgrade, etc) you may need to reset the device. Pushing the reset button results the same as you disconnect and reconnect the power adaptor to the transmitter. To resetting the device follow the steps:

- Step 1.** Push the button with a thin object for a second.
- Step 2.** Wait until the device reboots. You can use the transmitter when the LIVE LED is blinking slowly again.

**ATTENTION!** Resetting the device does not reset the settings to factory defaults. To reset factory default settings see previous section.

### 4.3.4. Control Lock



Press the **Audio Select** and **Show Me** buttons **together** (within 100 ms) to disable/enable front panel buttons; front panel LEDs blink 4 times when locking/unlocking. If the control lock is enabled and a button is pressed, front panel LEDs blink 3 times.

### 4.3.5. Entering Firmware Upgrade Mode



It may happen that the firmware upgrade process is not successful and the device cannot be switched to bootloader mode automatically. In this case, the device can be forced into firmware upgrade mode as follows:

- Step 1.** Make sure the transmitter is powered off.
- Step 2.** Press and keep pressed the **Show Me** button.
- Step 3.** Power on the transmitter while the **Show Me** button is being pressed. If the device is switched to firmware upgrade mode the LIVE LED is blinking quickly (less than 500 ms duty cycle). The other LEDs are off.

The procedure of firmware upgrade can be found in the [Firmware Upgrade](#) chapter.

## 4.4. Rear Panel Status LEDs

### 4.4.1. LIVE LED

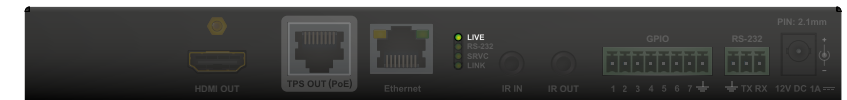

- OFF:** The device is not powered.
- BLINKING (slow):** The device is powered and operational.
- BLINKING (fast):** The device is in firmware upgrade (bootload) mode.
- ON:** The device is powered but not operational.

### 4.4.2. RS-232 LED

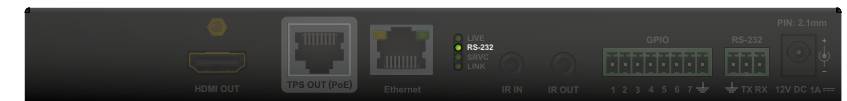

- OFF:** RS-232 ports (Local and Link) are in [Pass-through Mode](#).
- BLINKING:** [Command Injection Mode](#) is active.
- ON:** RS-232 ports (Local and Link) are in [Control Mode](#).

### 4.4.3. SRVC LED



Reserved for future developments.

### 4.4.4. LINK LED

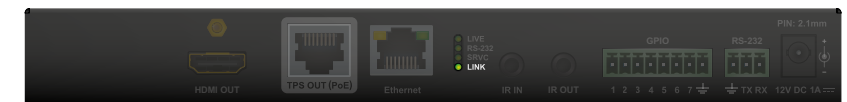

- OFF:** No TPS link between the transmitter and the receiver.
- BLINKING (slow):** Low power mode is active.
- BLINKING (fast):** Ethernet fallback mode is active.
- ON:** TPS link is established, HDBaseT or Long Reach mode is active.

See more details about TPS modes in the [TPS Interface](#) section.

## 4.5. Software Control Modes

User has more possibilities to control the device besides the front panel buttons. The following list contains the software control modes:

- **Lightware Device Controller (LDC)** - you can connect to the device via our control software using Ethernet or RS-232 interface and control or configure the device as you wish. For the details see the [Software Control - Lightware Device Controller](#) chapter.
- **LW2 protocol commands**: you can configure the device by using the reduced command set of LW2 protocol. For more details see the [LW2 Programmer's Reference](#) chapter.
- **LW3 protocol commands**: you can configure the device by using the full-range command set of LW3 protocol. For more details see the [LW3 Programmer's Reference](#) chapter.



# 5

## Software Control - Lightware Device Controller

The device can be controlled by a computer through Ethernet and RS-232 interfaces by the Lightware Device Controller (LDC). The software can be installed on a Windows PC or Mac OS X. The application and the User's Manual can be downloaded from [www.lightware.com](http://www.lightware.com).

- ▶ INSTALL AND UPGRADE
- ▶ ESTABLISHING THE CONNECTION
- ▶ CROSSPOINT MENU
- ▶ PORT PROPERTIES WINDOWS
- ▶ DIAGNOSTIC TOOLS
- ▶ EDID MENU
- ▶ CONTROL MENU
- ▶ EVENT MANAGER
- ▶ SETTINGS MENU
- ▶ CONFIGURATION CLONING (BACKUP TAB)
- ▶ ADVANCED VIEW WINDOW

### 5.1. Install and Upgrade

**INFO:** After the installation, the Windows and the Mac application has the same look and functionality. This type of the installer is equal with the Normal install in case of Windows and results an updateable version with the same attributes.

#### Installation for Windows OS

Run the installer. If the User Account Control drops a pop-up message click **Yes**.

During the installation you will be prompted to select the type of the installation: **normal** and the **snapshot** install:

Normal install	Snapshot install
Available for Windows and Mac OS X	Available for Windows
The installer can update only this instance	Cannot be updated
Only one updateable instance can exist for all users	More than one different version can be installed for all users

#### Comparison of installation types

**ATTENTION!** Using the Normal install as the default choice is highly recommended.

#### Installation for Mac OS X

Mount the DMG file with double clicking on it and drag the LDC icon over the Applications icon to copy the program into the Applications folder. If you want to copy the LDC into another location just drag the icon over the desired folder.

#### Upgrading of LDC

**Step 1.** Run the application.

The **Device Discovery** window appears automatically and the program checks the available updates on Lightware's website and opens the update window if the LDC found updates.

The current and the update version number can be seen at the top of the window and they are shown in this window even with the snapshot install.

The **Update** window can also be opened by clicking the **About** icon  and the **Update** button.

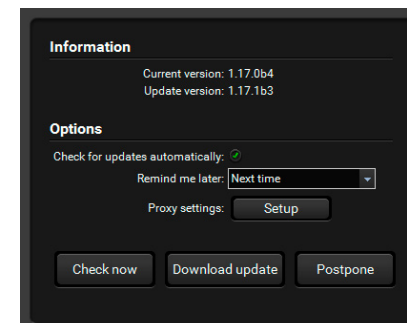

**Step 2.** Set the desired update setting in the **Options** section.

- If you do not want to check for the updates automatically, uncheck the **circle**, which contains the green tick.
- If you want to postpone the update, a reminder can be set with different delays from the **drop down list**.

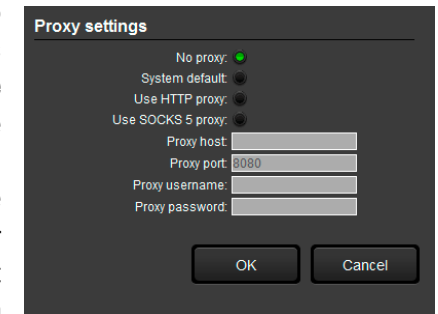

- If the proxy settings traverse the update process, set the proper values then click the **OK** button.

**Step 3.** Click the **Download update** button to start the upgrading.

The updates can be checked manually by clicking the **Check now** button.

### 5.2. Establishing the Connection

**Step 1.** Connect the device to a computer via Ethernet or RS-232.

**Step 2.** Run the controller software; device discovery window appears automatically.

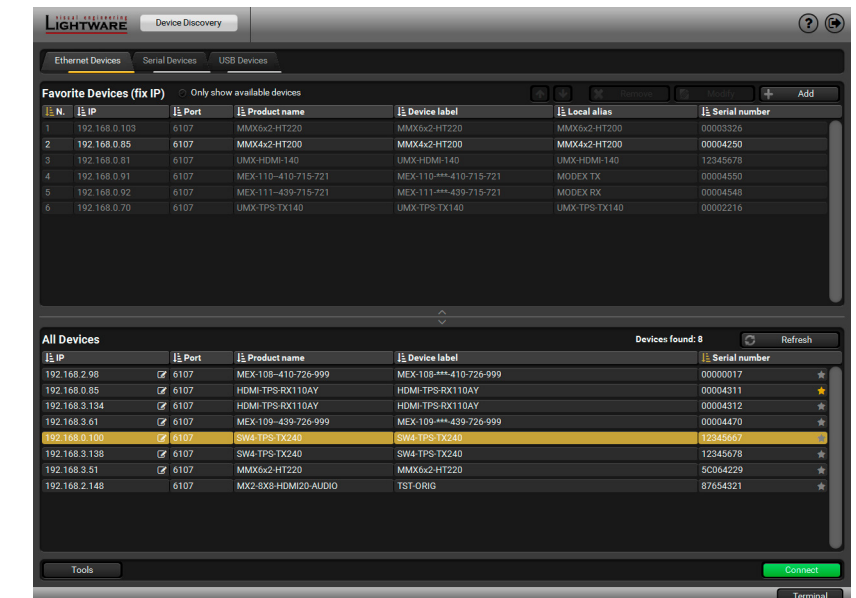

Device discovery window in LDC

### Change IP Address

To modify IP address settings quickly it is not necessary to enter the device's settings/network menu, you can set them by clicking the pencil icon beside the IP address.

You can see the new settings only in this window.

This will change the IP address settings of the selected device remotely.

DHCP  Fix IP

Serial number: 00004148

IP Address: 192.168.0.100

Network mask:

Default gateway:

**Step 3.** Select the unit from the discovered Ethernet devices or under Serial devices; when the device is connected through RS-232 click on the **Query** button next to the desired serial port to display the device's name and serial number. Double click on the transmitter or select the device and click on the **Connect** button.

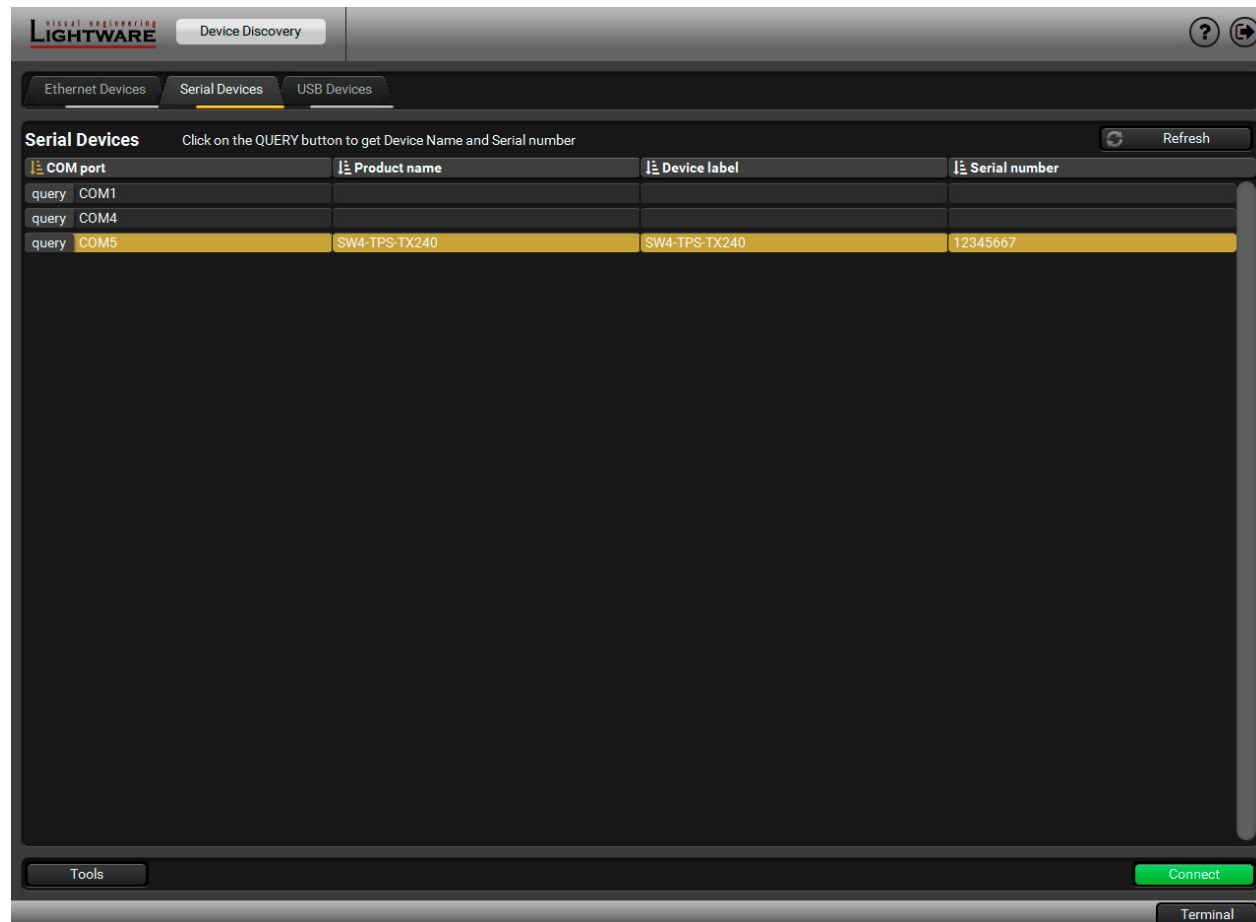

**ATTENTION!** Before the device is connected via the local RS-232 port, make sure that **Control mode** and **LW3 protocol** are set on the serial port.

### 5.3. Crosspoint Menu

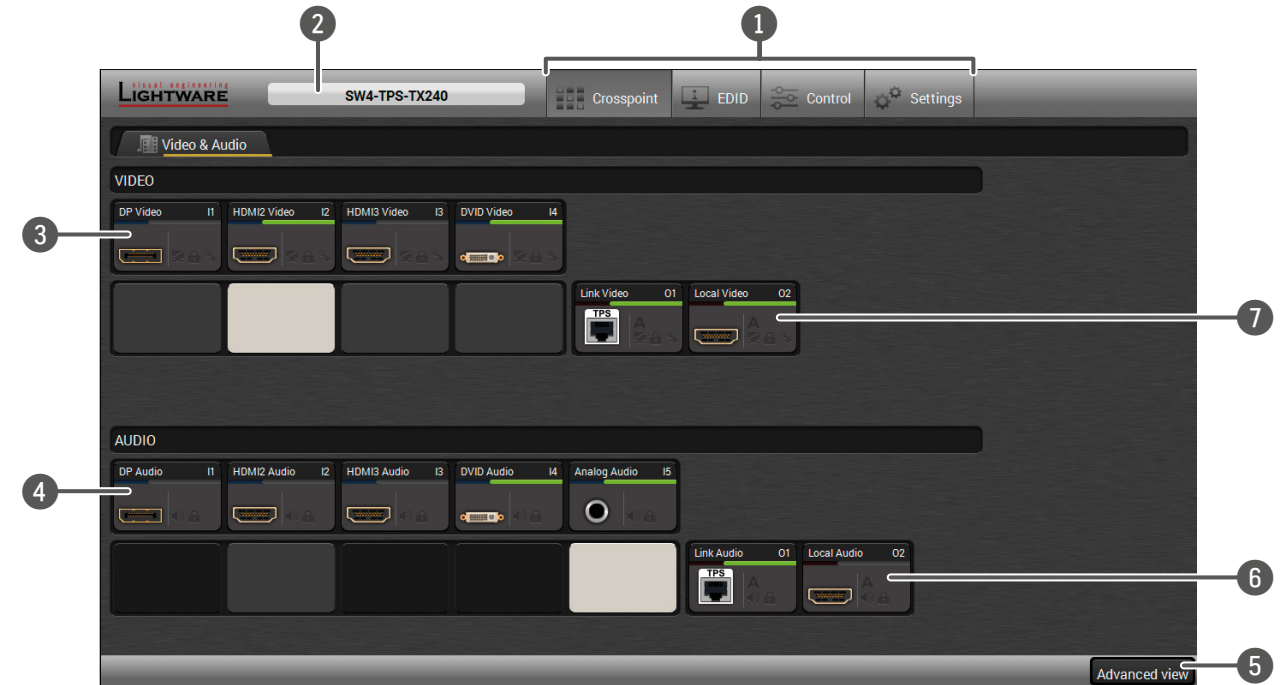

- 1 Main menu** The available menu items are displayed. The active one is showed with dark grey background color.
- 2 Information ribbon** The label shows the device label which can be edited in the Settings menu - [Status](#) tab. Device discovery window can be displayed by clicking on this ribbon.
- 3 Video input ports** Each tile represents a video input port. The tile below the port shows the current crosspoint setting; if the port is switched to the output, the color of the tile is white, otherwise grey.
- 4 Audio input ports** Each tile represents an audio input port. The tile below the port shows current crosspoint setting; if the port is switched to the output, the color of the tile is white, otherwise grey. Dark grey means the audio port is not allowed to embed in the current video input port.
- 5 Advanced view** Displaying the [Advanced View Window](#), showing the Terminal window and the LW3 protocol tree.
- 6 Audio output ports** The audio output of the TPS out and HDMI out ports. Clicking on the tile opens the [Audio Outputs \(TPS and HDMI\)](#) port properties window.
- 7 Video output ports** The video output of the TPS out and HDMI out ports. Clicking on the tile opens the [Video Outputs \(TPS and HDMI\)](#) port properties window.



**Port Tiles**

The colors of the port tiles and the displayed icons represent different states and information:

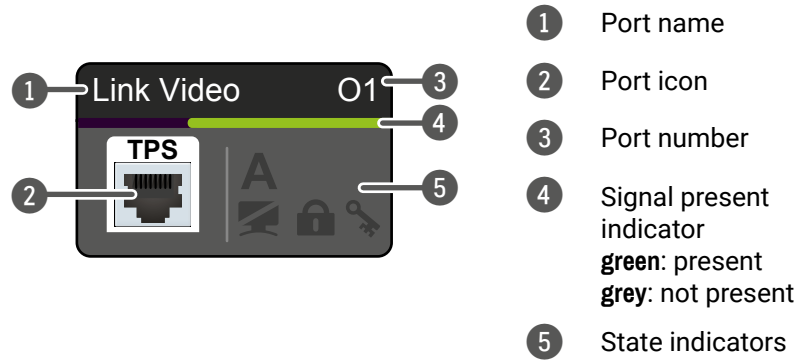

- 1 Port name
- 2 Port icon
- 3 Port number
- 4 Signal present indicator  
green: present  
grey: not present
- 5 State indicators

**State Indicators**

Following icons display different states of the port/signal:

Icon	Icon is grey	Icon is black	Icon is green
	Signal is not encrypted with HDCP	Signal is encrypted with HDCP	-
	Port is unmuted	Port is muted	-
	Port is unlocked	Port is locked	-
	Autoselect is disabled	-	Autoselect is enabled

**5.4. Port Properties Windows**

Clicking on the port tile opens the Port properties window. This section shows the available settings and status information by port types.

**5.4.1. Digital Video Inputs**

Clicking on the HDMI, DisplayPort, or DVI-D video input port icon results opening the Port properties window. The most important information and settings are available from the panel.

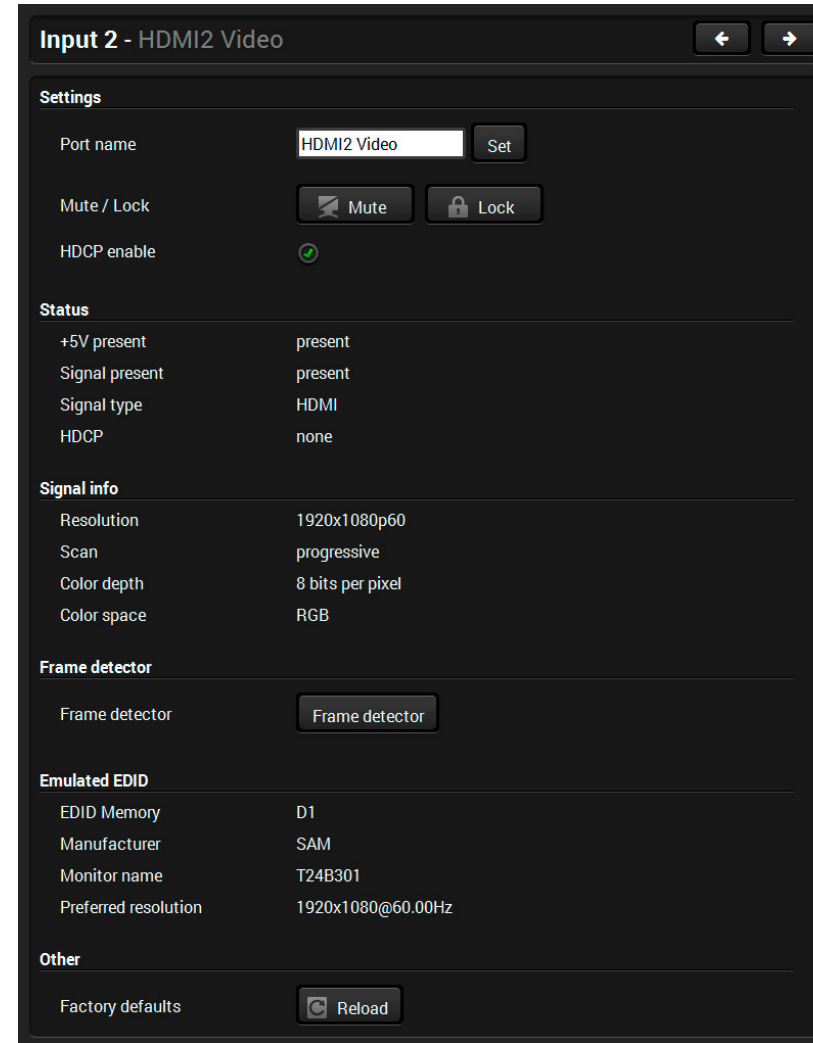

*Port properties window of the HDMI video input*

**Available settings:**

- Mute/unmute the port;
- Lock/unlock the port;
- HDCP setting (enable / disable);
- [Frame Detector](#);
- Reloading factory default settings for the selected port.

**5.4.2. Digital Audio Inputs**

Clicking on the HDMI, DisplayPort, or DVI-D audio input port icon results opening the Port properties window. The most important information and settings are available from the panel.

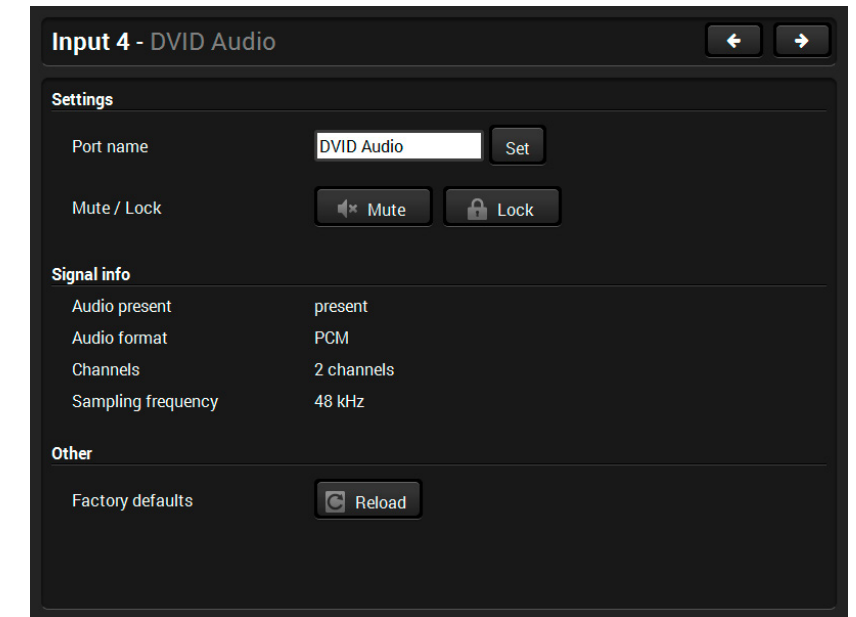

*Port properties window of the DVI-D audio input*

Certain parameters of the embedded audio input signal can be set as follows:

- Mute/unmute the port;
- Lock/unlock the port;
- Reloading factory default settings for the selected port.

### 5.4.3. Analog Audio Input

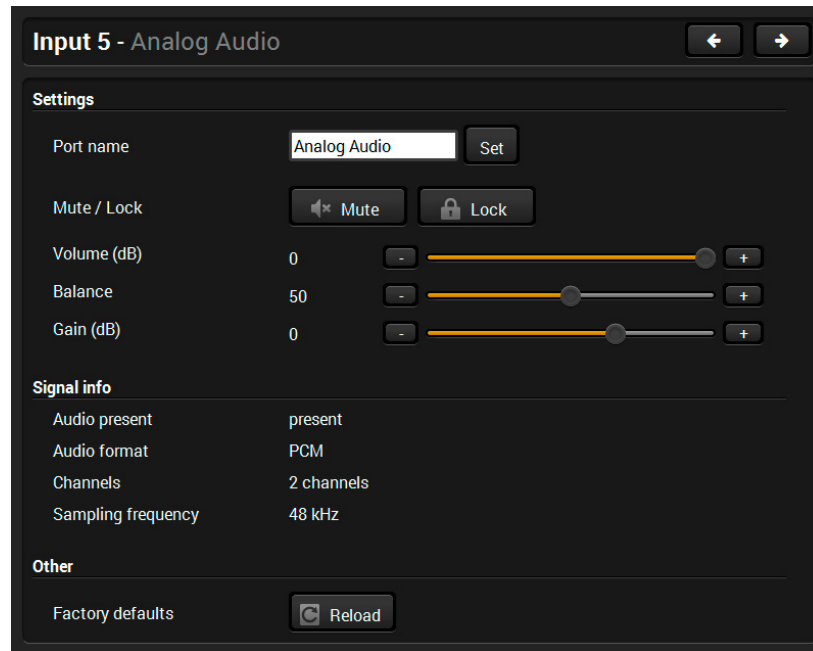

**Port properties window of the Analog Audio (Jack) input**

Certain parameters of the analog audio input signal can be set as follows:

- Mute/unmute the port;
- Lock/unlock the port;
- Volume: from 0 dB to -95.62 dB, in step 0.375 dB (default is 0 dB);
- Balance: from 0 to 100, in step 1 (default is 50 = center);
- Gain: -12 to 6 dB, in step 3 dB (default is 0 dB);
- Reloading factory default settings for the selected port.

### 5.4.4. Video Outputs (TPS and HDMI)

Click on the output port to display its properties. The most important information and settings are available from the panel.

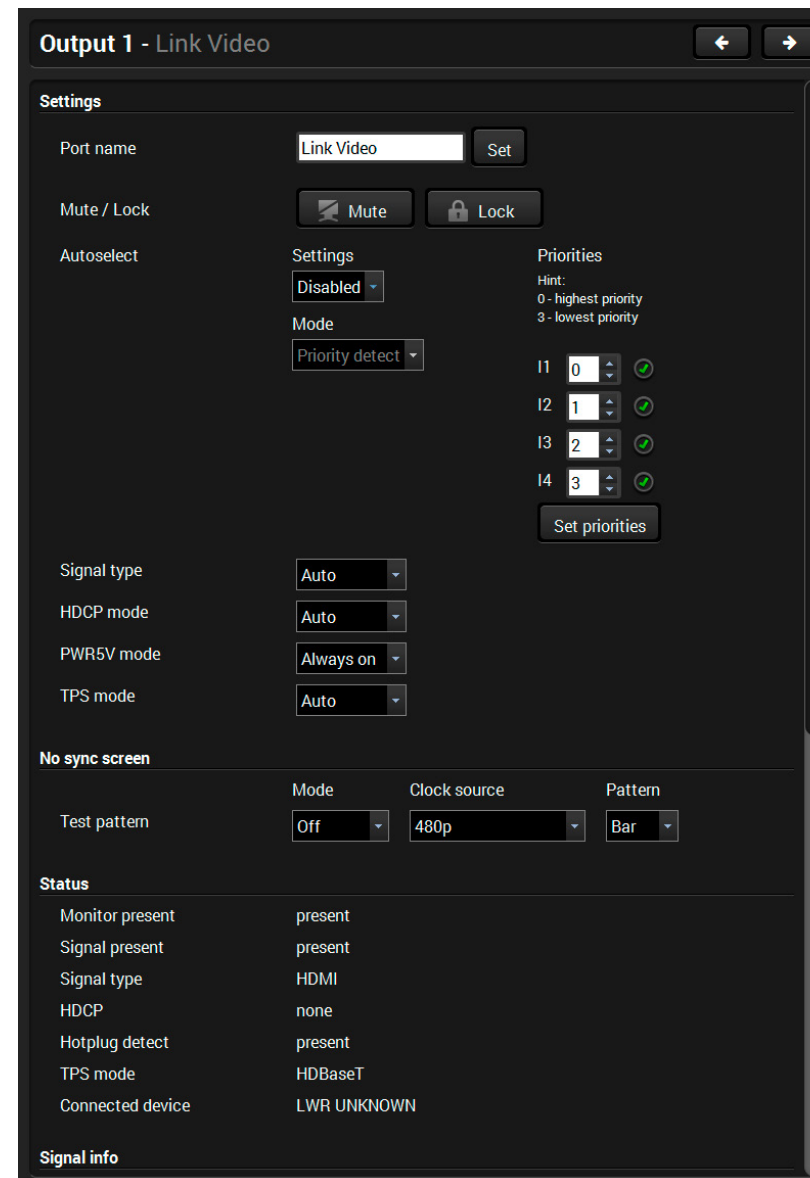

**Port properties window of the TPS video output**

#### Available settings:

- Mute/unmute the port;
- Lock/unlock the port;
- **Autoselect settings:** enable / disable, mode, and priorities. (See more details about Autoselect feature in [The Autoselect Feature](#) section);
- **Signal type:** Auto / DVI / HDMI - The outgoing signal format can be selected by a drop-down menu;
- **HDCP mode:** Auto / Always - The transmitter forces the source sent the signal without encryption if the content allows when Auto mode is selected;
- **Power 5V mode:** Auto / Always on / Always off - The setting lets the source and the sink devices be connected – independently from the transmitted signal;
- **TPS mode:** Auto / HDBaseT / Long reach / LPPF1 / LPPF2. See more information about TPS modes in the [TPS Interface](#) section.
- **No sync screen:** configuration settings of the test pattern. See more details in the [No Sync Screen \(Test Pattern\)](#) section.
- [Frame Detector](#);
- [Cable Diagnostics](#);
- Reloading factory default settings for the selected port.

### 5.4.5. Audio Outputs (TPS and HDMI)

Click on the output port to display its properties. The most important information and settings are available from the panel.

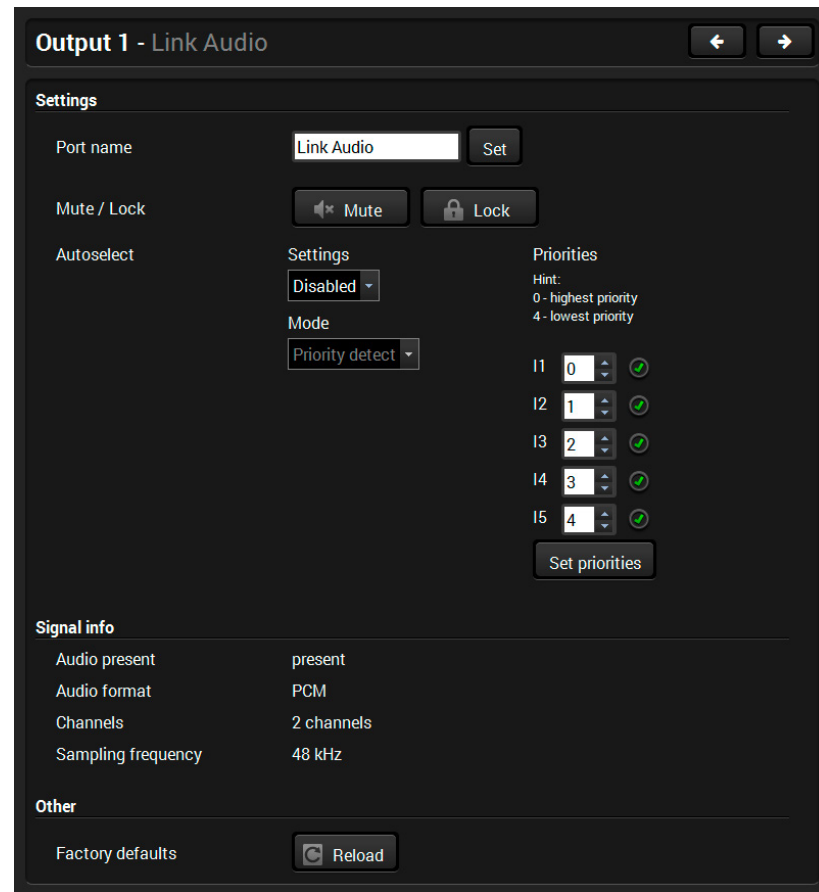

Port properties window of the TPS audio output

#### Available settings:

- Mute/unmute the port;
- Lock/unlock the port;
- **Autoselect settings:** enable / disable, mode, and priorities. (See more details about Autoselect feature in [The Autoselect Feature](#) section);
- Reloading factory default settings for the selected port.

## 5.5. Diagnostic Tools

### 5.5.1. Cable Diagnostics

The cable diagnostics is a useful tool to determine any cable related issues in case of TPS connection. The estimated cable length and the quality of the link are measured periodically and the diagnostic window shows the values in real-time. If the green bars hit the first line in the middle they turn into red. It means the number of the errors – during the extension – is higher than recommended. The link might be alive but recovering of the received data is not guaranteed.

INFO: Each bar represents a differential line in the CATx cable. The inappropriate termination of the cable usually causes high error rates. Check the cable terminations or change the cable.

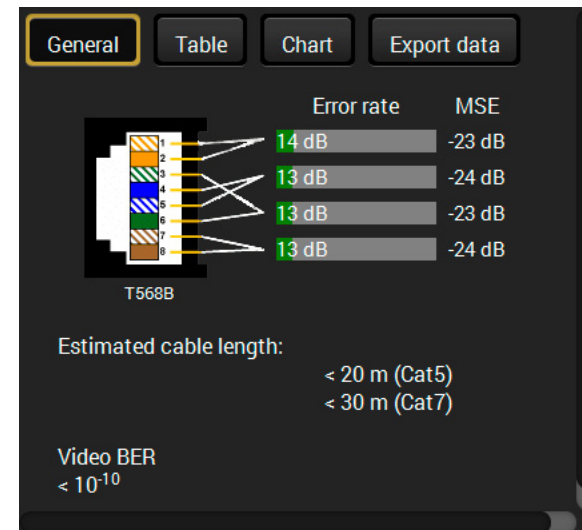

#### Reference Values

Value	Explanation
10 <sup>-10</sup> -10 <sup>-9</sup>	Excellent image quality
10 <sup>-8</sup>	Minor error, not recognizable by eyes
10 <sup>-7</sup>	Sometimes recognizable flash on a special test pattern
10 <sup>-6</sup>	Small noise can be seen
10 <sup>-5</sup>	Easy to recognize image error
10 <sup>-4</sup>	Bad image quality

Above displayed Video Bit Error Ratio (BER) means that on average there is 1 bad pixel after 10<sup>10</sup> pixels, which means the number of the bit errors is about 1 pixel in every 80 seconds at 1080p60 video signal.

INFO: You can find more details about maximum twisted pair cable distances in the [Maximum Extension Distances](#) section.

#### Table and Chart Views

Cable diagnostics can be displayed in advanced modes as well. Two ways are available: **table view** and **chart view**. Data can be exported to a file on clicking on the **Export data** button.

Date	MSE #1	MSE #2	MSE #3	MSE #4	Error rate #1	Error rate #2	Error rate #3	Error rate #4	Cable length
2016-11-12 09:57:23	-24	-22	-22	-22	28	52	32	34	< 20
2016-11-12 09:57:24	-24	-22	-22	-22	28	52	32	34	< 20
2016-11-12 09:57:25	-24	-22	-23	-23	28	46	30	34	< 20
2016-11-12 09:57:26	-24	-22	-22	-22	26	44	30	36	< 20
2016-11-12 09:57:27	-24	-22	-22	-22	26	44	30	36	< 20
2016-11-12 09:57:28	-24	-22	-23	-22	26	46	32	38	< 20
2016-11-12 09:57:29	-24	-22	-23	-22	26	46	32	38	< 20
2016-11-12 09:57:30	-24	-22	-23	-22	26	46	32	38	< 20

Table view of cable diagnostics

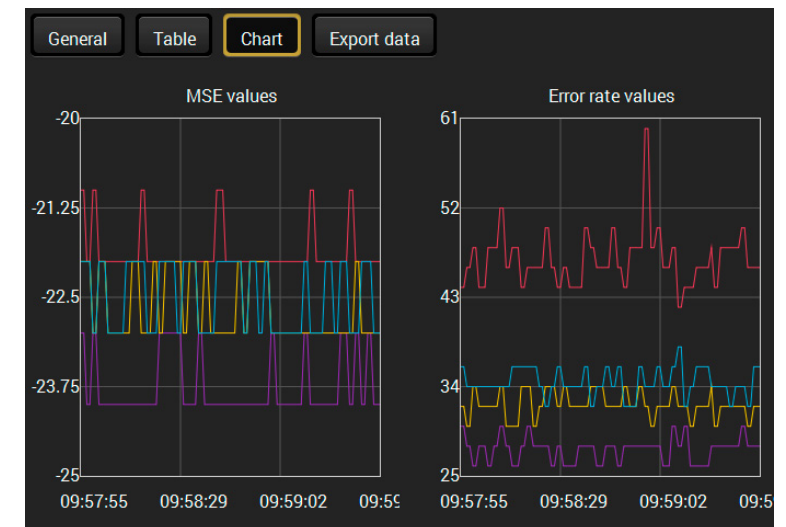
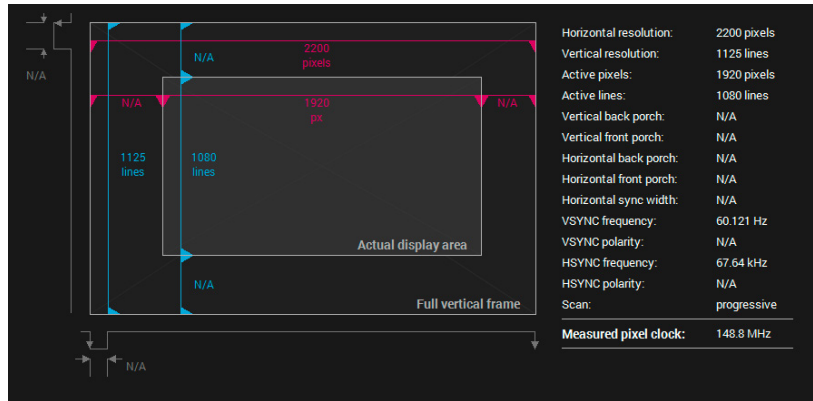

Chart view of cable diagnostics

### 5.5.2. Frame Detector

The ports can show detailed information about the signal like full size and active video resolution. This feature is a good troubleshooter if compatibility problems occur during system installation. To access this function, open the port properties window and click on **Frame detector** button.



**Frame detector window**

Lightware's Frame Detector function works like a signal analyzer and makes possible to determine the exact video format that is present on the port, thus helps to identify many problems. E.g. actual timing parameters may differ from the expected and this may cause some displays to drop the picture.

Frame Detector measures detailed timings on the video signals just like a built-in oscilloscope, but it is much more easy to use. Actual display area shows the active video size (light grey). Dark grey area of the full frame is the blanking interval which can contain the info frames and embedded audio data for HDMI signals. Shown values are measured actually on the signal and not retrieved only from the HDMI info frames.

### 5.5.3. No Sync Screen (Test Pattern)

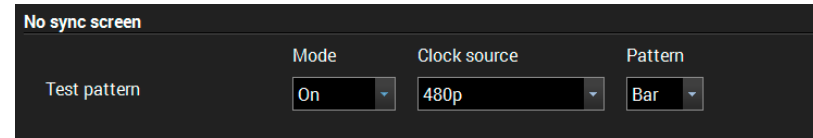

#### **No sync screen options in the port properties window of TPS output**

The No sync screen feature generates an image which can be displayed when there is no incoming signal on the port. The following settings can be set for the Test Pattern function:

#### **Mode**

- **On:** the video output port always transmits the test pattern.
- **No signal:** the video output port transmits the test pattern if there is no incoming signal on the selected input port.
- **Off:** the test pattern function is disabled, the video output port transmits the video signal of the selected input port.

#### **Clock Source**

- 480p
- 576p
- Original video signal

#### **Pattern**

- Red
- Green
- Blue
- Black
- White
- Ramp
- Chess
- Bar
- Cycle

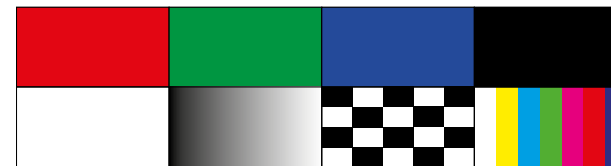

**ATTENTION!** However the mode of the Test pattern can be set at each port separately, the clock source and the pattern settings are common.



## 5.6. EDID Menu

Advanced EDID Management can be accessed by selecting the EDID menu. There are two panels: left one contains Source EDIDs, right one contains Destination places where the EDIDs can be emulated or copied.

The screenshot shows the EDID menu interface for device SW4-TPS-TX240. It features two main panels: 'Source' (left) and 'Emulated' (right). Both panels have tabs for 'Factory', 'Dynamic', and 'User'. The 'Source' panel lists EDIDs F1-F22, and the 'Emulated' panel lists EDIDs U1-U14. A yellow highlight is visible on row F1 in the Source panel and row U5 in the Emulated panel. At the bottom, there are control buttons: Export, Import, Info, Edit, Create, a right-pointing arrow, Delete selected, Select all, and Select none. An 'Advanced view' button is located at the bottom right of the interface.

Mem...	Manu...	Resolution	Audio	Monitor Name
F1	LWR	640x480@60.00Hz	N/A	D640x480p60
F2	LWR	848x480@60.00Hz	N/A	D848x480p60
F3	LWR	800x600@60.32Hz	N/A	D800x600p60
F4	LWR	1024x768@60.00Hz	N/A	D1024x768p60
F5	LWR	1280x768@50.00Hz	N/A	D1280x768p50
F6	LWR	1280x768@59.94Hz	N/A	D1280x768p60
F7	LWR	1280x768@75.00Hz	N/A	D1280x768p75
F8	LWR	1360x768@60.02Hz	N/A	D1360x768p60
F9	LWR	1280x1024@50.00Hz	N/A	D1280x1024p50
F10	LWR	1280x1024@60.02Hz	N/A	D1280x1024p60
F11	LWR	1280x1024@75.02Hz	N/A	D1280x1024p75
F12	LWR	1400x1050@50.00Hz	N/A	D1400x1050p50
F13	LWR	1400x1050@60.00Hz	N/A	D1400x1050p60
F14	LWR	1400x1050@75.00Hz	N/A	D1400x1050p75
F15	LWR	1680x1050@60.00Hz	N/A	D1680x1050p60
F16	LWR	1920x1080@50.00Hz	N/A	D1920x1080p50
F17	LWR	1920x1080@60.00Hz	N/A	D1920x1080p60
F18	LWR	2048x1080@50.00Hz	N/A	D2048x1080p50
F19	LWR	2048x1080@60.00Hz	N/A	D2048x1080p60
F20	LWR	1600x1200@50.00Hz	N/A	D1600x1200p50
F21	LWR	1600x1200@60.00Hz	N/A	D1600x1200p60
F22	LWR	1920x1200@50.00Hz	N/A	D1920x1200p50

Mem...	Manu...	Resolution	Audio	Monitor Name
U1	LWR	1920x1080@60.00Hz	N/A	Univ_DVI
U2	LWR	1920x1080@60.00Hz	2chLPCM,8ch...	Univ_HDMI_ALL
U3	LWR	3840x2160@30.00Hz	2chLPCM	Univ_4k_PCM
U4	LWR	3840x2160@30.00Hz	2chLPCM,8ch...	Univ_4k_ALL
U5	N/A	N/A	N/A	N/A
U6	N/A	N/A	N/A	N/A
U7	N/A	N/A	N/A	N/A
U8	N/A	N/A	N/A	N/A
U9	N/A	N/A	N/A	N/A
U10	N/A	N/A	N/A	N/A
U11	N/A	N/A	N/A	N/A
U12	N/A	N/A	N/A	N/A
U13	N/A	N/A	N/A	N/A
U14	N/A	N/A	N/A	N/A

EDID menu

### Control Buttons

	Exporting an EDID (save to a file)		Transfer button: executing EDID emulation or copying
	Importing an EDID (load from a file)		Deleting EDID (from User memory)
	Display EDID Summary window		Selecting all memory places in the right panel
	Opening Advanced EDID Editor with the selected EDID		Selecting none of the memory places in the right panel
	Opening Easy EDID Creator		

### 5.6.1. EDID Operations

#### Changing Emulated EDID

**Step 1.** Choose the desired **EDID list** on the source panel and select an **EDID**.

**Step 2.** Press the **Emulated** button on the top of the Destination panel.

**Step 3.** Select the desired **port** on the right panel (one or more ports can be selected); the EDID(s) will be highlighted with a yellow cursor.

**Step 4.** Press the **Transfer** button to change the emulated EDID.

#### Learning an EDID

The process is the same as changing the emulated EDID; the only difference is the Destination panel: press the **User** button. Thus, one or more EDIDs can be copied into the user memory either from the factory memory or from a connected sink (Dynamic).

#### Exporting an EDID

**ATTENTION!** This function is working on Windows and Mac OS X operating systems and under Firefox or Chrome web browsers only.

Source EDID can be downloaded as a file (\*.bin, \*.dat or \*.edid) to the computer.

**Step 1.** Select the desired **EDID** from the Source panel (line will be highlighted with yellow).

**Step 2.** Press the **Export** button to open the dialog box and save the file to the computer.

#### Importing an EDID

Previously saved EDID (\*.bin, \*.dat or \*.edid file) can be uploaded to the user memory:

**Step 1.** Press the **User** button on the top of the Source panel and select a **memory slot**.

**Step 2.** Press the **Import** button below the Source panel.

**Step 3.** Browse the file in the opening window then press the **Open** button. Browsed EDID is imported into the selected User memory.

**ATTENTION!** The imported EDID overwrites the selected memory place even if it is not empty.

#### Deleting EDID(s)

The EDID(s) from User memory can be deleted as follows:

**Step 1.** Press **User** button on the top of the Destination panel.

**Step 2.** Select the desired **memory slot(s)**; one or more can be selected ("Select All" and "Select None" buttons can be used). The EDID(s) will be highlighted with yellow.

**Step 3.** Press the **Delete selected** button to delete the EDID(s).

### 5.6.2. EDID Summary Window

Select an EDID from Source panel and press **Info** button to display EDID summary.



**General**

EDID version:	1
EDID revision:	3
Manufacturer ID:	SAM (Samsung Electric Company)
Product ID:	8E09
Monitor serial number:	Not present
Year of manufacture:	2012
Week of manufacture:	9
Signal interface:	Digital
Separate Sync H&V:	-
Composite sync on H:	-
Sync on green:	-
Serration on VS:	-
Color depth:	Undefined
Interface standard:	Not defined
Color spaces:	RGB 4:4:4 & YCrCb 4:4:4
Aspect ratio:	0.56
Display size:	52 cm X 29 cm

*EDID summary window*

### 5.6.3. Editing an EDID

Select an EDID from Source panel and press Edit button to display Advanced EDID Editor window. The editor can read and write all descriptors, which are defined in the standards, including the additional CEA extensions. Any EDID from the device's memory or a saved EDID file can be loaded into the editor. The software resolves the raw EDID and displays it as readable information to the user. All descriptors can be edited, and saved in an EDID file, or uploaded to the User memory. For more details about EDID Editor please visit our website ([www.lightware.com](http://www.lightware.com)) and download EDID Editor user's manual.



**Basic EDID**

- Vendor / Product Information
- Display Parameters
- Power Management and Features
- Gamma / Color and Established Timings
- Standard Timings
- Preferred Timing Mode
- 2nd Descriptor Field
- 3rd Descriptor Field
- 4th Descriptor Field
- CEA Extension
- General
- Video Data
- Audio Data
- Speaker Allocation Data
- HDMI
- Colorimetry
- Detailed Timing Descriptor #1
- Detailed Timing Descriptor #2
- Detailed Timing Descriptor #3
- Detailed Timing Descriptor #4
- Detailed Timing Descriptor #5
- Detailed Timing Descriptor #6
- Save EDID

**EDID Byte Editor**

	0	1	2	3	4	5	6	7	8	9
0	00	FF	FF	FF	FF	FF	FF	00	4C	2D
10	8E	09	00	00	00	00	09	16	01	03
20	80	34	1D	78	0A	7D	D1	A4	56	50
30	A1	28	0F	50	54	BD	EF	80	71	4F
40	81	C0	81	00	81	80	95	00	A9	C0
50	B3	00	01	01	02	3A	80	18	71	38
60	2D	40	58	2C	45	00	09	25	21	00
70	00	1E	66	21	56	AA	51	00	1E	30
80	46	8F	33	00	09	25	21	00	00	1E
90	00	00	00	FD	00	18	4B	1A	51	17
100	00	0A	20	20	20	20	20	20	00	00
110	00	FC	00	54	32	34	42	33	30	31
120	0A	20	20	20	20	20	01	6C		

*EDID Editor window*

### 5.6.4. Creating an EDID - Easy EDID Creator

Since above mentioned Advanced EDID Editor needs more complex knowledge about EDID, Lightware introduced a wizard-like interface for fast and easy EDID creation. With Easy EDID Creator it is possible to create custom EDIDs in four simple steps. By clicking on the **Create** button below Source panel, **Easy EDID Creator** is opened in a new window. For more details about EDID Editor please visit our website ([www.lightware.com](http://www.lightware.com)) and download EDID Editor user's manual.

*EDID Creator window*

## 5.7. Control Menu

### 5.7.1. RS-232

*RS-232 tab in Control menu*

The following settings and functions are available on the **local** and **TPS link** RS-232 port:

- **Operation mode:** Control, Pass-through, and Command Injection (for more details about serial interface modes see the [Serial Interface](#) section);
- Baud rate: 4800, 7200, 9600, 14400, 19200, 38400, 57600, 115200;
- Data bits: 8 or 9;
- Parity: None, Odd, or Even;
- Stop bits: 1, 1.5, or 2;
- Command injection: enable or disable;
- Command injection port number;
- Control protocol: LW2 or LW3;
- Message sending via serial port;
- Reloading [Factory Default Settings](#).

**ATTENTION!** The RS-232 **Operation mode** is mirrored on the Local and Link serial port. The other settings can be adjusted separately on the two ports.



## 5.7.2. GPIO

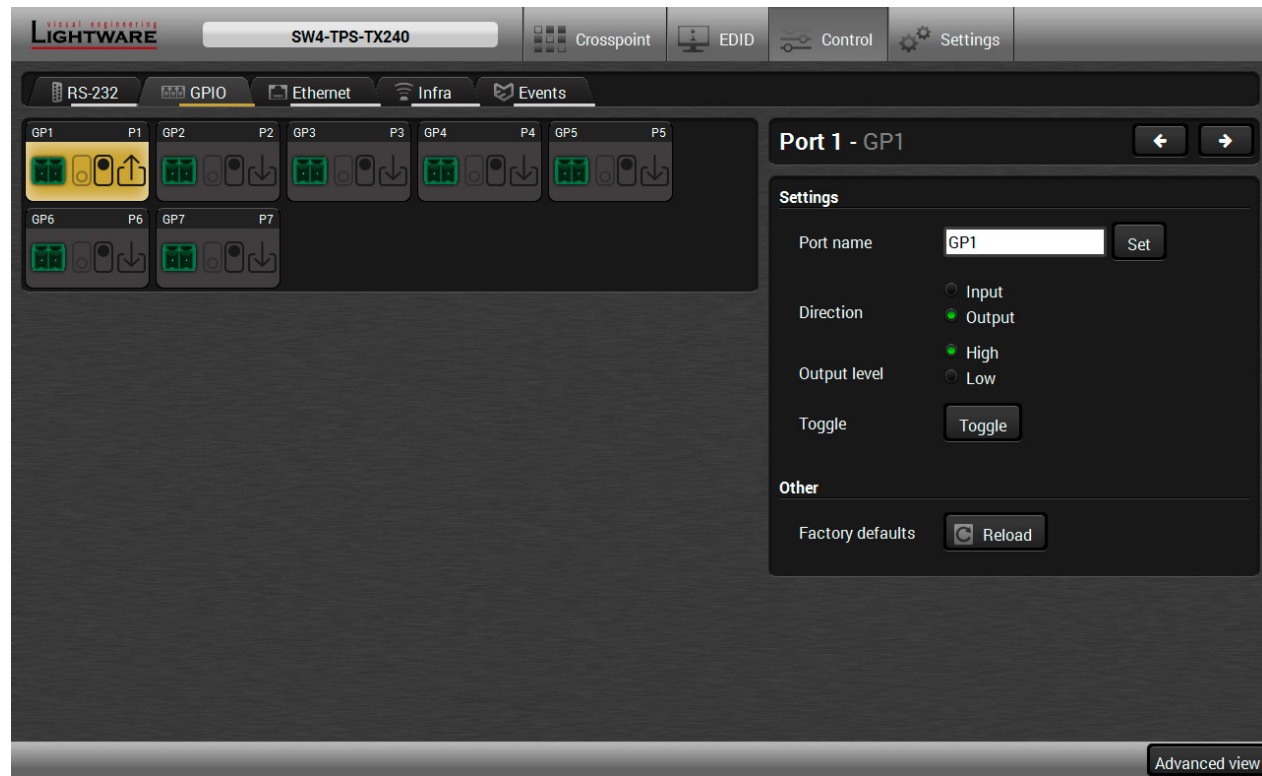

GPIO tab in Control menu

The GPIO port has 7 pins, which operate at TTL digital signal levels and can be controlled by LDC or protocol commands. Select a GPIO pin and under the Port settings section; the settings (pin direction and input level) are displayed on the port tiles as well:

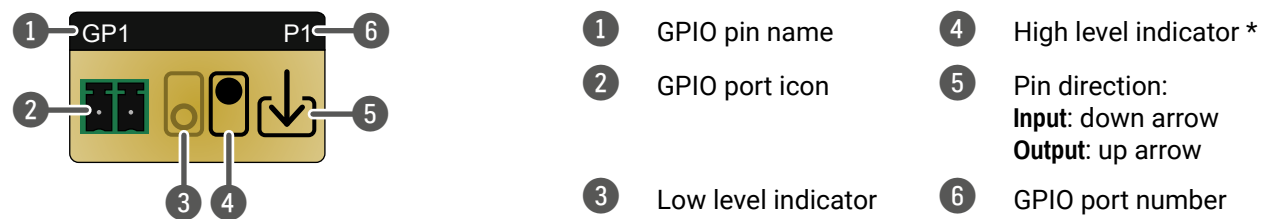

\* Highlighted with black means the current setting.

INFO: Output level can be set only in case of setting the pin direction to Output. In case of input direction the output level setting and the Toggle button is not available.

For more details about GPIO interface see the [GPIO Interface](#) section.

## 5.7.3. Ethernet

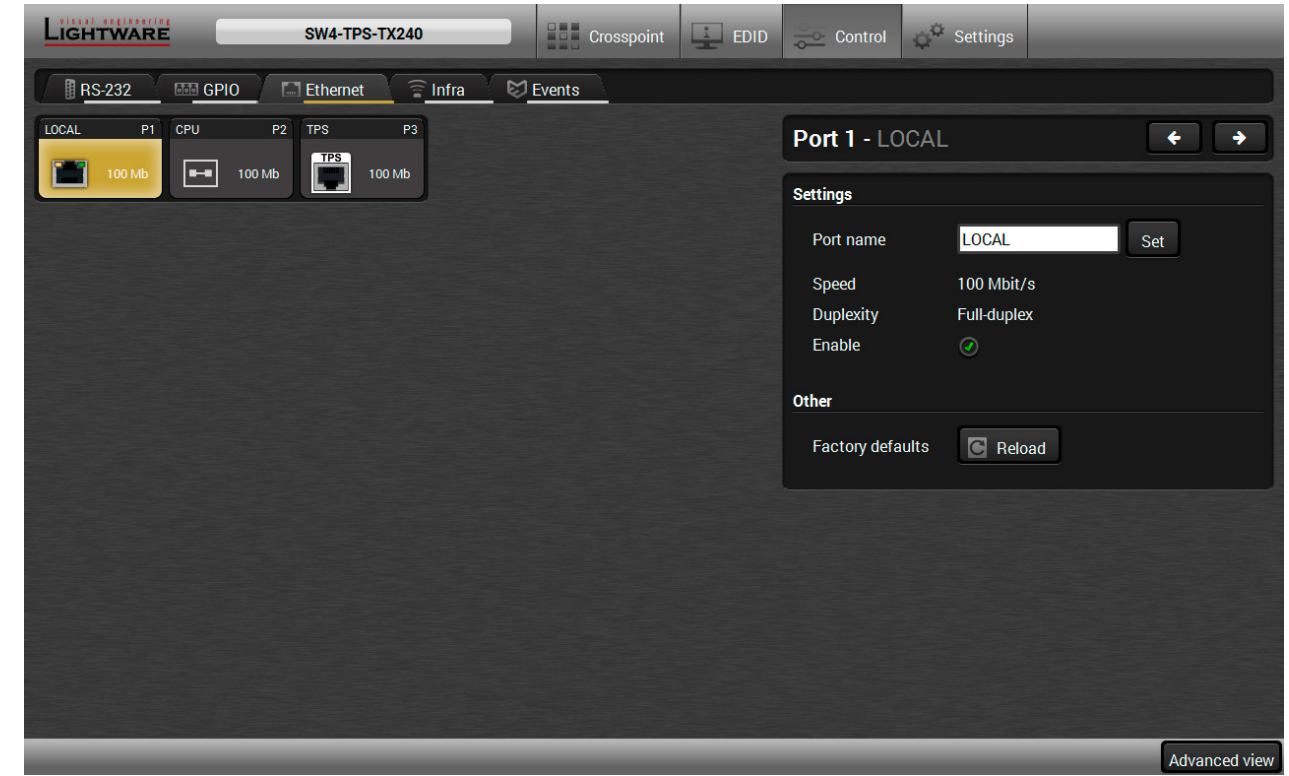

Ethernet tab in Control menu

Two ports are displayed in the Ethernet settings: Local, CPU, and TPS. You can check the status of the Ethernet line by each ports: the speed and the duplexity of the connection.

The following settings are available for the local port:

- Enable / disable the port;
- Reloading factory defaults.

**ATTENTION!** If the Ethernet port is set to disabled, this may break the connection with the device.

INFO: CPU Ethernet port cannot be disabled.

### 5.7.4. Infra

**ATTENTION!** The device has no built-in Infrared receiver and transmitter. For the complete usage attach an IR emitter unit to the IR OUT and an IR detector unit to the IR IN connectors.

Infra-Red (IR) receiver and transmitter options can be found on this tab. There are three submenus available under it: **IR codes**, **Ports**, and **Clear all IR codes**.

#### IR Codes

User can set the name of the IR code, the fingerprint (hash), and the repeat timeout in ms, as well as actions can be ordered to each IR codes.

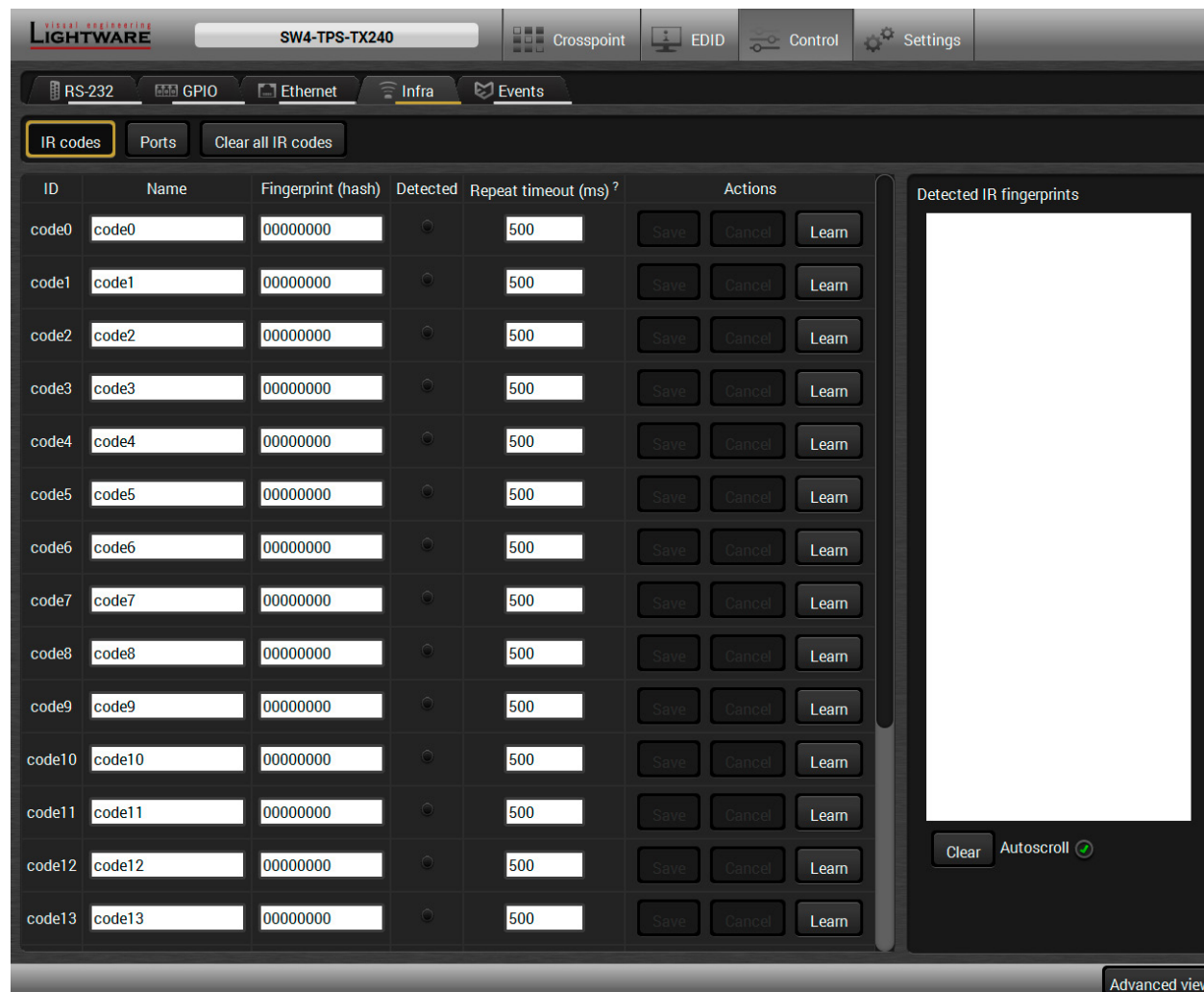

*IR codes window in Control menu*

Description	Function
<b>ID</b>	Code number.
<b>Name</b>	You can give an unique name for the desired code.
<b>Fingerprint (hash)</b>	Fingerprint code in pronto hexa format.
<b>Detected</b>	Indicator gives feedback about the given IR code is detected currently.
<b>Repeat timeout (ms)</b>	You can set a timeout to avoid the involuntary code recurrence.
<b>Actions</b>	Action buttons for the desired IR code: <b>Save:</b> saving the fingerprint. <b>Cancel:</b> canceling the fingerprint. <b>Learn:</b> learning the detected IR code.
<b>Detected IR fingerprints</b>	You can check the detected IR codes in this panel. Pushing <b>Clear</b> button deleting all current fingerprints and switch on or off the automatic scrolling with the <b>Autoscroll</b> pipe.

20 fingerprints can be stored in the device at the same time. Each of them can be ordered to an action in [Event Manager](#).

#### Learning IR Codes

- Step 1.** Connect the IR detector unit to the IR IN port of the transmitter.
- Step 2.** Click on the **Learn** button.
- Step 3.** Turn the remote controller to the IR detector. A pop-up window appears in LDC - press your remote button to learn.
- Step 4.** Once the code is received, a new window pops up in LDC - learning completed. Click **OK** to continue.
- Step 5.** Optionally type a unique name for the code in the **Name** text box. The default name is code#, e.g. code0.

## Ports

User can set the name and command injection port to each sources and destinations. For more details about IR interface see the [IR Interface](#) section.

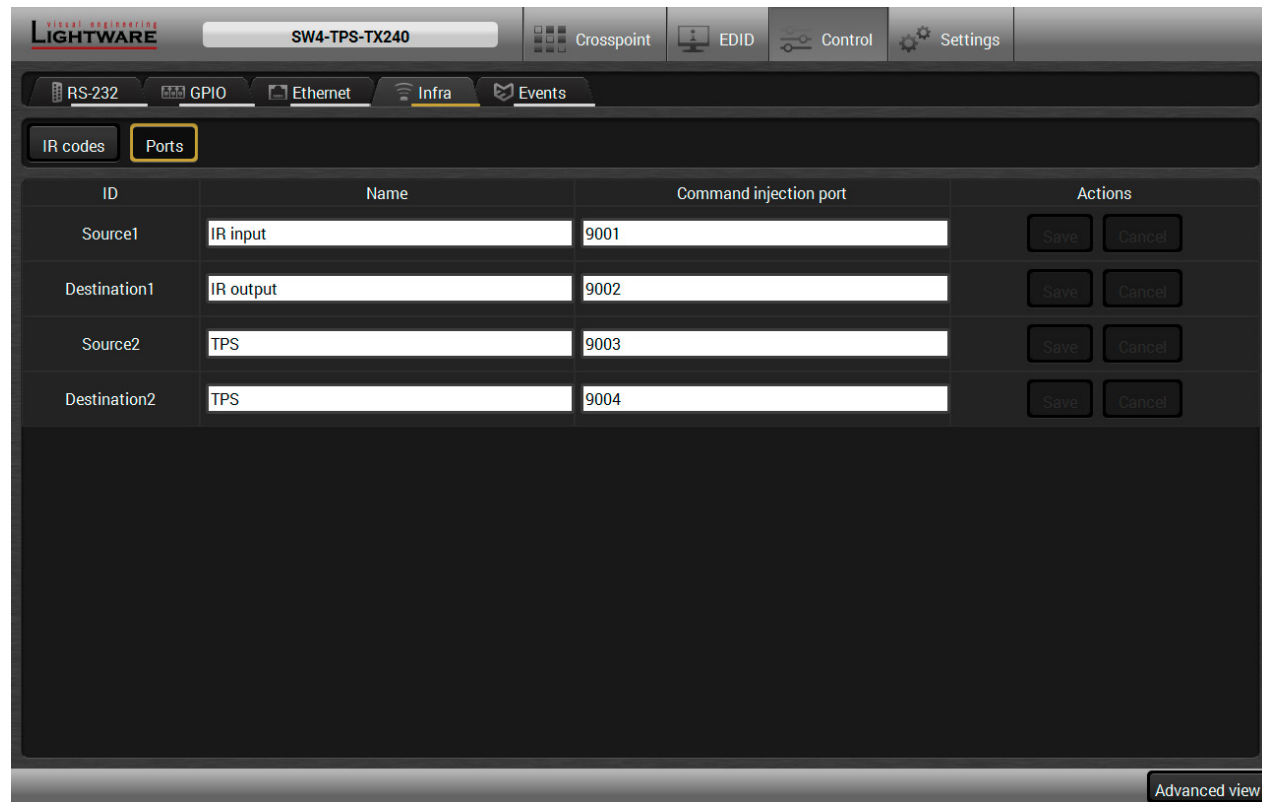

*Infra tab - Ports window*

## Clear all IR codes

Clicking on the button results deleting all stored IR fingerprints.

## 5.8. Event Manager

The feature means that the device can sense changes on its ports and able to react according to the pre-defined settings. The development idea of the Event manager is based on users' feedbacks. In many cases internal events (such as signal present or HDCP active) are necessary to display but it is not easy when the device is hard to access (e.g. built under the desk).



The Event manager can be configured to perform an action if a condition has been detected. E.g. the desired setup is that after a certain type of signal has been detected on I1 port, the port has to be switched to O1. The settings can be done via the LDC in the Control/Events tab, or by LW3 protocol commands. Configurable events number depends on the device what you are using actually.

Numerous new ideas and requests have been received in connection with the features and settings of the Event manager since the first release. Therefore, the user interface has been re-designed and many new functions implemented. The Event editor can be opened by pressing the **Edit** button at each Event.

There is a **grey bar** on the left of the Event panel in each line. If a condition and an action are set and the Event is enabled, the bar is displayed in **green**.

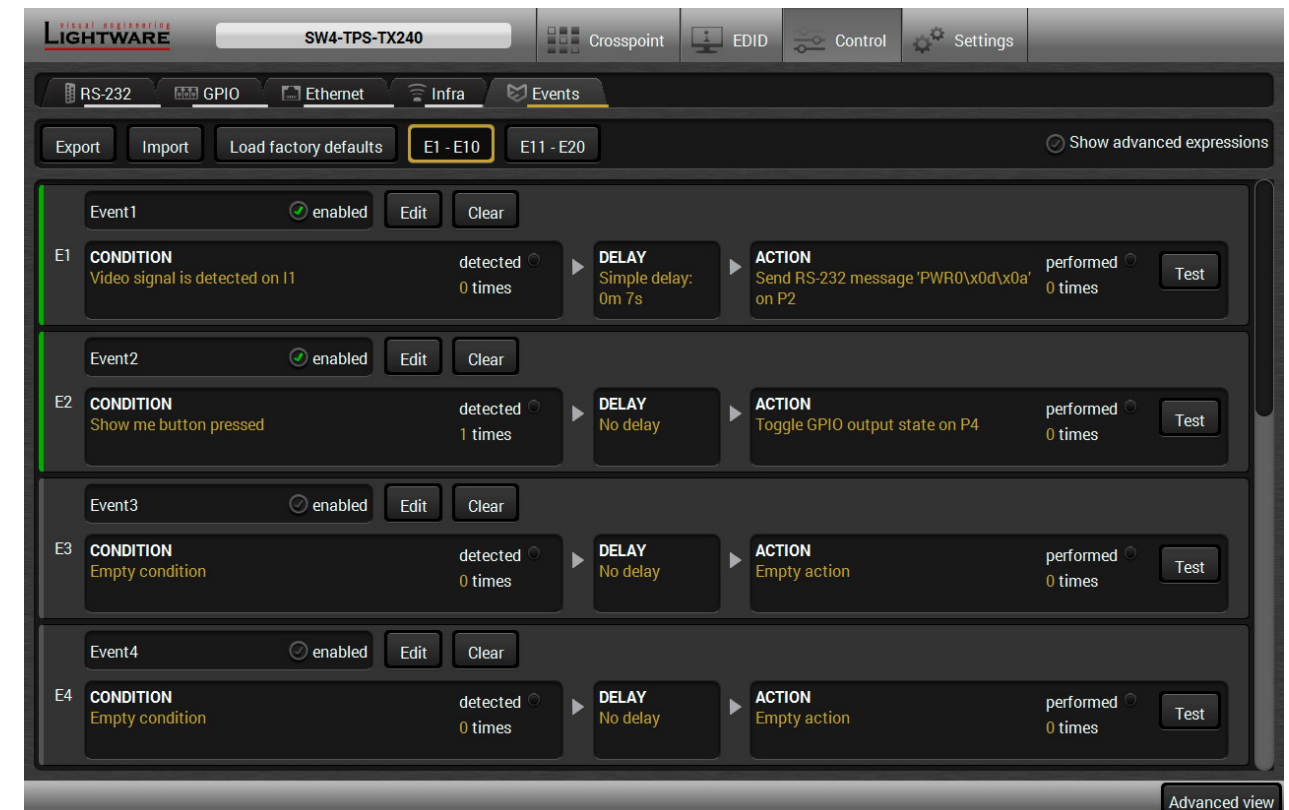

*Control menu, Event Manager tab*

### 5.8.1. The Event Editor

Press the **Edit** button in the desired Event line to open the Event editor window.

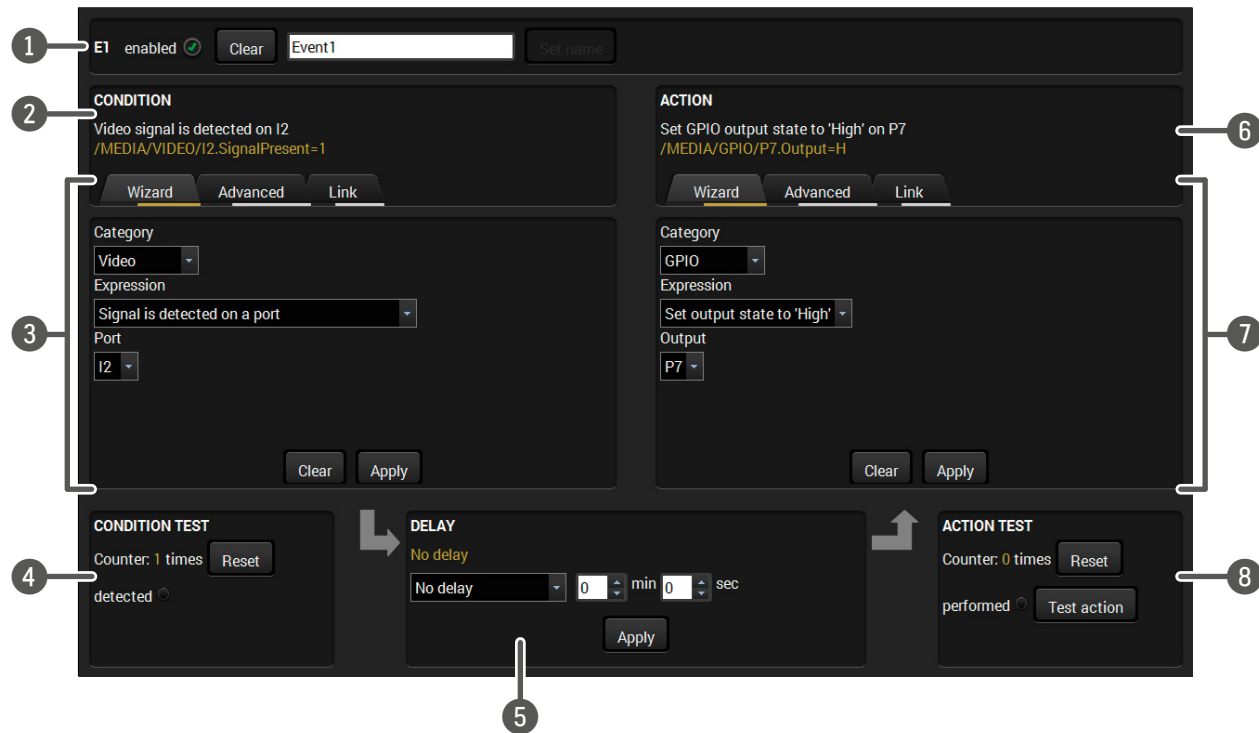

- 1 **Event header** The name of the Event is displayed. Type the desired name and press the Set name button. The Event can be cleared by the Clear button. Use the tick mark to enable/disable the Event.
- 2 **Condition header** If the condition is set, the description (white colored text) and the exact LW3 protocol expression (yellow colored text) can be seen. If the advanced mode was used the description is "Custom condition".
- 3 **Condition panel** The Wizard, the Advanced or the Link tool is available to set the condition. The parameters and settings are displayed below the buttons.
- 4 **Condition test** The set condition can be tested to see the working method in the practice.
- 5 **Delay settings** The action can be scheduled to follow the condition after the set time value.
- 6 **Action header** If the action is set, the description (white colored text) and the exact LW3 protocol expression (yellow colored text) can be seen. If the advanced mode was used the description is "Custom action".
- 7 **Action panel** The Wizard, the Advanced or the Link tool is available to set the action. The parameters and settings are displayed below the buttons.
- 8 **Action test** The set action can be tested to see the working method in the practice.

### 5.8.2. Create or Modify an Event

#### Wizard Mode

The wizard mode lists the most common conditions and actions, so the user does not have to look for LW3 nodes and properties.

- Step 1.** Click on the **Edit** button of the desired Event; the **Event editor** is displayed.
- Step 2.** The wizard mode is displayed as default. Select the desired **Category** first (e.g. Audio or Video).
- Step 3.** Select the desired **Expression** from the drop-down menu. If any other parameter is necessary to set, it is going to be displayed.
- Step 4.** Press the **Apply** button to store the settings of the Condition.

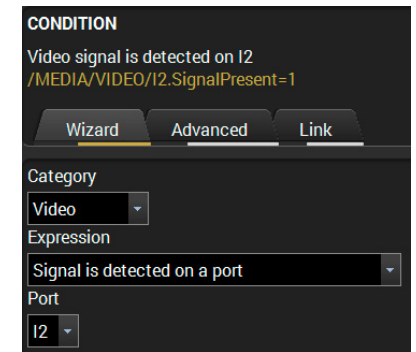

#### Advanced Mode

The goal of this mode is the same as of the wizard: set the properties and methods for conditions and actions. The difference is the number of the available and usable properties and methods of the LW3 protocol. Advanced mode allows almost all of it.

- Step 1.** Click on the **Edit** button of the desired Event; the **Event editor** is displayed.
- Step 2.** The wizard mode is the default, press the **Advanced** button. The LW3 protocol tree is displayed showing the list of the properties in the drop-down menu. Navigate to the desired node.
- Step 3.** Select the desired **Property** from the menu. The **manual** of the property is displayed below to help to select the necessary property and to set the value.
- Step 4.** Set the desired **value** and **operator**, then press the **Apply** button to store settings.

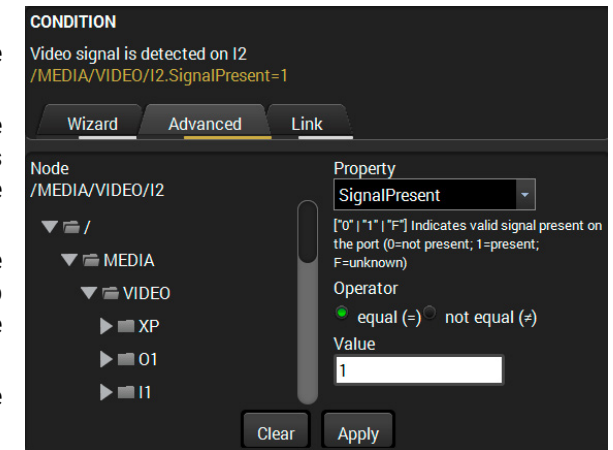

#### The Link Tool

The new interface allows creating more actions to the same condition. In that case, a condition can trigger more actions. To set such an Event, the Link tool has been introduced.

- Step 1.** Click on the **Edit** button of the desired Event; the **Event editor** is displayed.
- Step 2.** The wizard mode is displayed as default, press the **Link** button.
- Step 3.** All the saved Events are analyzed and the **conditions** are listed (it takes some seconds to finish). The **Show advanced expressions** option allows showing the exact path and set the value of the given property.
- Step 4.** Select the desired **Condition** and press the **Apply** button to store the settings.

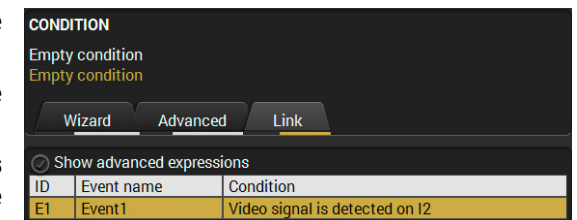



### 5.8.3. Special Tools and Accessories

#### The Name of the Event

The name of a port can be changed by typing the new name and clicking the **Set** button. The following characters are allowed when naming:

Letters (A-Z) and (a-z), numbers (0-9), special characters: hyphen (-), underscore (\_), and space ( ).

#### Enable or Disable an Event

The set Event can be enabled or disabled in the Event list, or directly in the Event editor window by setting the **tick mark** beside the name.

#### Testing the Condition

When the desired Condition is arranged, the setting can be tested. The Event list and the Event editor contains a small panel that shows if the set condition is detected and how many times. The **Counter** can be reset by the button in Event editor. If the Condition is true, the **detected** mark turns green for two seconds and the **Counter** is increased.

#### Testing the Action

The method is the same as testing the Condition, but in this case, the Action can be triggered manually by pressing the **Test** button.

**TIPS AND TRICKS:** The Test button is also placed on the Action panel in the Event list. Thus, you can check the Actions without opening the Event editor.

#### Delay the Action

In most cases the Action is performed immediately after the Condition is detected. But sometimes a delay is necessary between the Condition and the Action. Therefore, the new Event manager contains the Delay panel which allows that feature with below settings:

- **No delay:** when the Condition is detected, the Action is launched.
- **Simple delay:** when the Condition is detected, the Action is launched after the set time interval.
- **Still exists:** when the Condition is detected, the Action is launched after the set time interval only if the Condition still exists.
- **Continuously exists:** when the Condition is detected, the Action is launched after the set time interval only if the Condition has been existing continuously.

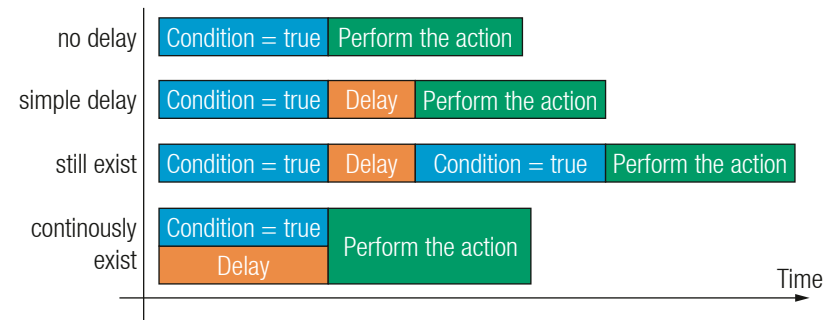

*The available delay settings of an Event*

**TIPS AND TRICKS:** **Show advanced expressions** option is a useful tool when you look for the path or value of a property but just the expression is displayed. The option is available in the Event list window or when Link tool is used.

### 5.8.4. Clear One or More Event(s)

#### Clear an Event

Press the **Clear** button in the Event list or in the header section in the Event editor.

#### Clear all Events

When all the Events must be cleared press the **Load factory defaults** button above the Event list. You will be prompted to confirm the process.

### 5.8.5. Export and Import Events

The feature allows saving all the Events. The backup file can be uploaded to another HDMI-TPS-TX200 series transmitter.

#### Export all the Events

**Step 1.** Press the **Export** button above the Event list.

**Step 2.** The Save as dialog box will appear. Set the desired folder and file name, then press the **Save** button.

The generated file is a simple text file which contains LW3 protocol commands. The file can be viewed by a simple text editor, e.g. Notepad.

**ATTENTION!** Editing the file is recommended only for expert users.

#### Import all the Events

**Step 1.** Press the **Import** button above the Event list.

**Step 2.** The Open dialog box will appear. Select the desired folder and file, then press the **Open** button.

### 5.8.6. Event Creating - Example

The following example shows you on a real-life situation how to set up an Event.

#### The Concept

The SW4-TPS-TX240 is connected to a projector by the TPS output port. The transmitter is also connected to the projector by the RS-232 port and can send commands via the serial line.

The task is to turn on the projector when signal is detected on the TPS output port.

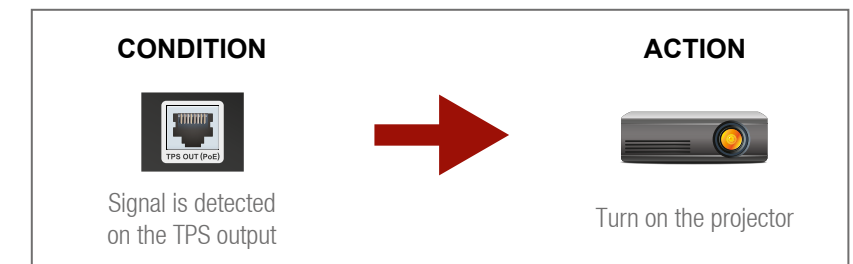

#### RS-232 Settings

Make sure that the serial line is established between the transmitter and the projector. Check that the RS-232 settings of the transmitter is set exactly the same which required for the projector: baud rate, data bits, parity, stop bits. The transmitter needs to be set to: Control protocol: LW3; and RS-232 mode: Pass-through. See the relevant LDC settings in the [RS-232](#) section.



## Setting the Event

You can create the Event in the Wizard in few simple steps:

**Step 1.** Set the condition.

Select the required parameters to set the condition:

- **Category:** Video;
- **Expression:** Signal is detected on a port;
- **Port:** O1.

Click on the **Apply** button to complete the procedure. When it is done, the condition appears on the upper side in textual and LW3 command format as well.

**Step 2.** Set the action.

If the condition is fulfilled, the following action needs to be launched: the receiver sends a command to the projector over the serial line:

- **Power on** - the required command which is accepted by the projector: PWR0<CR><LF>

For this instance the command has to be closed with the <CR><LF> characters so they need to be escaped. You can use the following format for escaping:

```
<command1><\x0d\x0a><command2><\x0d\x0a>...
...<commandn><\x0d\x0a>
```

In the current case the command is: PWR0\x0d\x0a

Select the required parameters to set the action:

- **Category:** RS-232;
- **Expression:** Send RS-232 message;
- **Port:** P1;
- **Message:** PWR0\x0d\x0a

**Step 3.** Enable the Event.

Select the **E1 enabled** pipe in upper left corner to set the Event as launched.

E1 enabled 

**INFO:** If you do not find the required category/expression/etc what you need, choose the Advanced mode in the Wizard where the entire LW3 structure tree is available. For example instead of signal detection you can set a specified resolution or color range either as a condition.

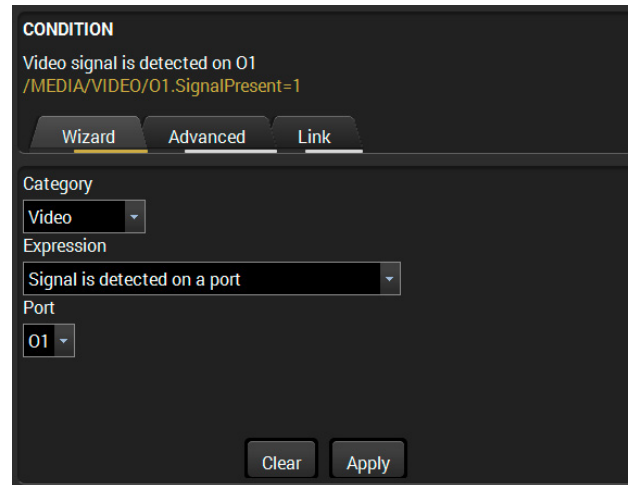
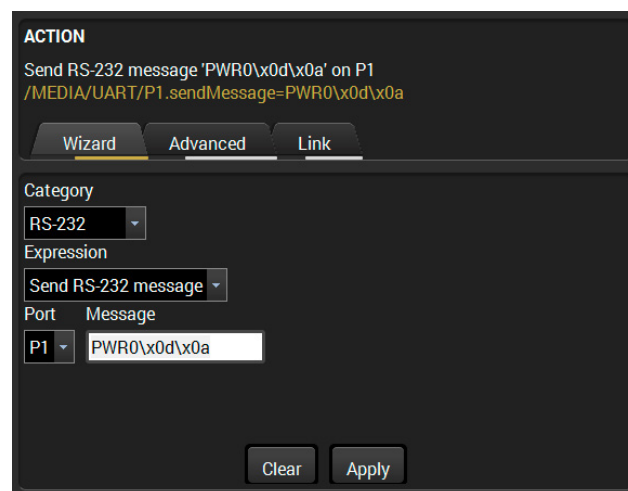
## 5.9. Settings Menu

### 5.9.1. Status

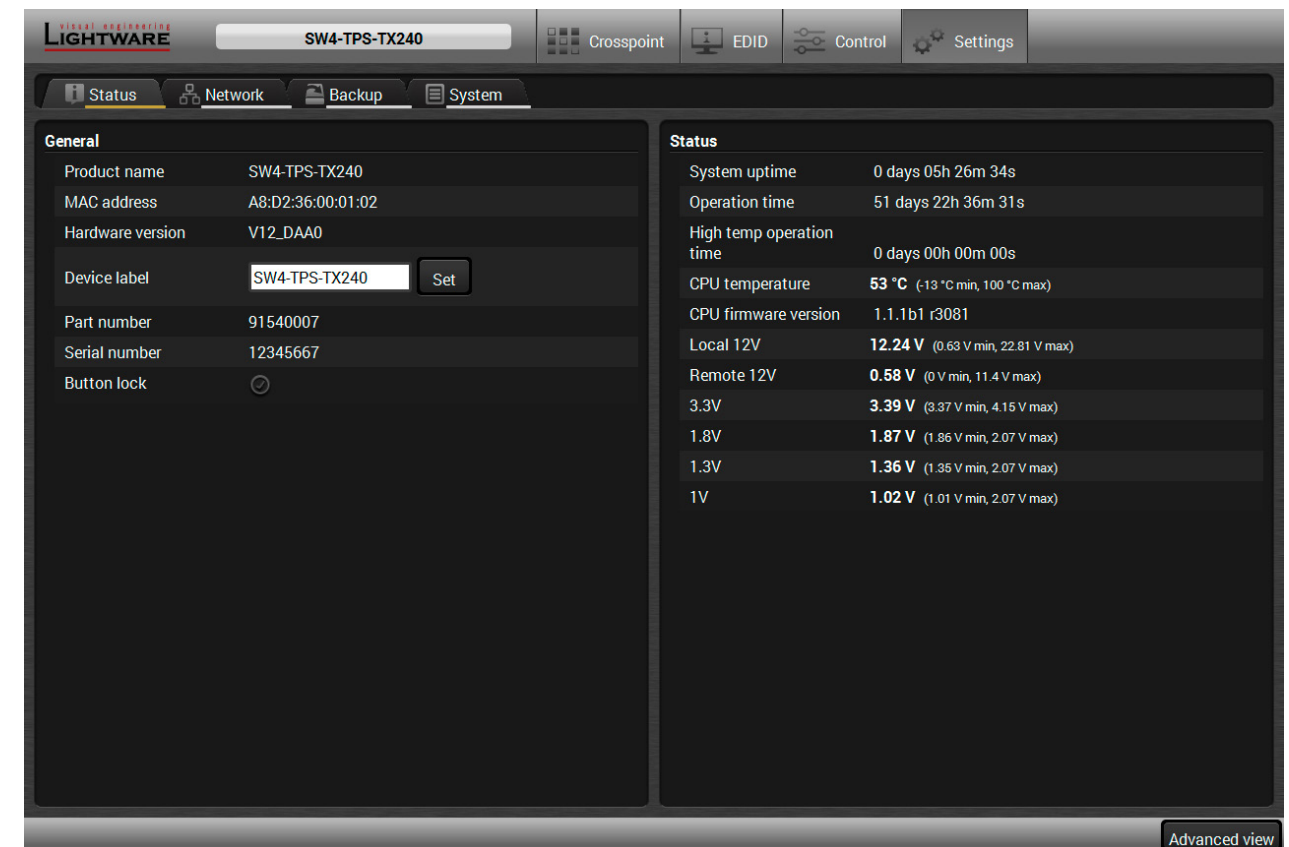

*Status tab in Settings menu*

The most important hardware and software related information can be found on this tab: hardware and firmware version, serial numbers, temperatures, operation time, and voltage information. Device label can be changed to unique description by the **Set** button.

You can disable the functionality of the front panel buttons with marking the **Button lock** option. This is same method of the control lock made by the front panel buttons. See the details in the [Control Lock](#) section.

### 5.9.2. Network

The screenshot displays the 'Network' tab within the 'Settings' menu. The top navigation bar includes 'Status', 'Network', 'Backup', and 'System'. The 'Network' tab is active. The 'General' section contains the following fields:

Current IP address	192.168.0.74
Current subnet mask	255.255.255.0
Current gateway address	192.168.0.1
Obtain IP address automatically (DHCP, AutoIP)	<input checked="" type="checkbox"/>
Static IP address	192.168.0.74
Static subnet mask	255.255.255.0
Static gateway address	192.168.0.1
LW2 port	10001
LW3 port	6107
HTTP port	80

At the bottom, there are three buttons: 'Apply changes', 'Cancel', and 'Load factory defaults'. An 'Advanced view' button is located in the bottom right corner.

**Network tab in Settings menu**

IP address and DHCP settings can be set on this tab. Always press the **Apply settings** button to save changes. Factory defaults settings can be recalled with a dedicated button.

### 5.9.3. Backup

Details about this function can be found in the [Configuration Cloning \(Backup Tab\)](#) section.

### 5.9.4. System

The screenshot displays the 'System' tab within the 'Settings' menu. The top navigation bar includes 'Status', 'Network', 'Backup', and 'System'. The 'System' tab is active. The interface contains three main sections:

- Download system log:** A button labeled 'System log'.
- Load factory defaults:** A button labeled 'Factory defaults'.
- Reboot device:** A button labeled 'Reboot'.

An 'Advanced view' button is located in the bottom right corner.

**System tab in Settings menu**

Three functions are available under System tab:

- **Download system log** - saving the file of the device.
- **Load factory defaults** - recalling factory defaults settings and values. All factory default settings are listed in the [Factory Default Settings](#) section.
- **Reboot** - rebooting the system.

## 5.10. Configuration Cloning (Backup Tab)

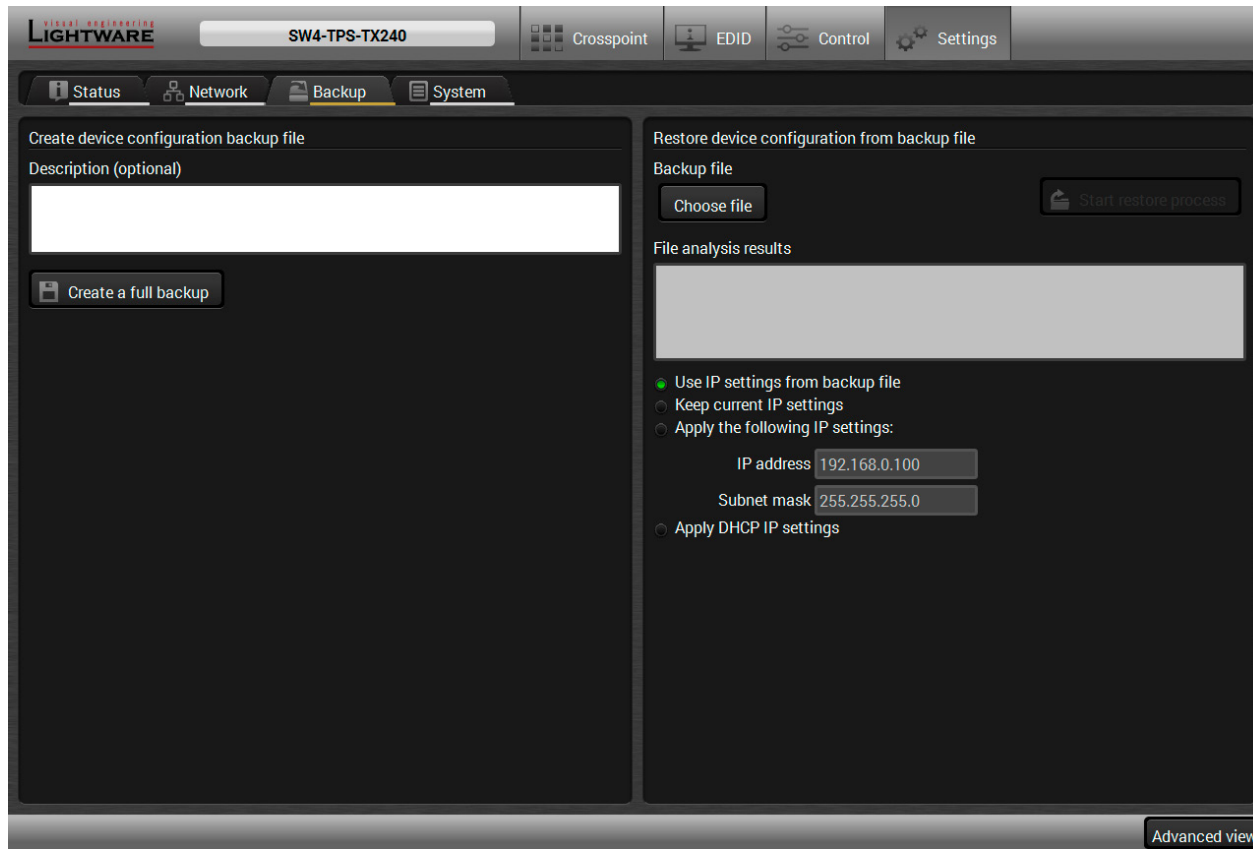

**Backup tab**

Configuration cloning of Lightware LW3 devices is a simple method that eliminates the need to repeatedly configure certain devices to have identical (non-factory) settings. If the devices are installed in the same type of system multiple times then it is enough to set up only one device to fit the user's needs and then copy those settings to the others, thus saving time and resources.

### 5.10.1. Steps in a Nutshell

Installing multiple devices with the same customized configuration settings can be done in a few easy steps:

- Step 1.** Configure one device with all your desired settings using the LDC software.
- Step 2.** Backup the full configuration file to your computer.
- Step 3.** If needed, make some modifications to the configuration file using a text editor (e.g. Notepad). E.g. modifying the static IP address is necessary when DHCP is not used.
- Step 4.** Connect to the other device which has to be configured and upload (restore) your configuration file.
- Step 5.** Done! You can have as many totally identical, customized devices as you like.

### 5.10.2. Save the Settings of a Device (Backup)

- Step 1.** Apply the desired settings in the transmitter (port parameters, crosspoint, etc.)
- Step 2.** Select the **Settings / Backup** tab from the menu.
- Step 3.** Write a short **description** in the text box on the left (optional).
- Step 4.** Press the **Create a full backup** button. You will be prompted to save the file to the computer. The default file name is the following:

```
BACKUP_<DEVICE TYPE>_SN<SERIAL NUMBER>.LW3
```

- Step 5.** Set the desired **file name**, select the folder and **save** the file.

**TIPS AND TRICKS:** Using the exact product type in the filename is recommended since it makes the file usage more comfortable.

#### About the Backup File

The backup file is a simple text file which contains LW3 protocol commands. The first line is the description and the further lines are the commands which will be executed during the restore process. The file can be viewed (and/or edited) by a simple text editor, e.g. Notepad.

See the entire list of saved data in the [Content of Backup File](#) section.

**ATTENTION!** Editing the command lines is only recommended for expert users.

### 5.10.3. Upload the Settings to a Device (Restore)

**WARNING!** Please note that the settings will be permanently overwritten with the restored parameters in the device. Undo is not available.

**ATTENTION!** The cloning is successful when the backup file is downloaded from the same type of source device as the destination device.

#### The Restoring Process

- Step 1.** Select the **Settings / Backup** tab from the menu.
- Step 2.** Click on the **Choose file** button on the right panel and **browse** to the desired file.
- Step 3.** The file is verified and the result will be displayed in the textbox below. If the file is correct, then the settings can be restored.
- Step 4.** Choose **IP settings** what you want to use after backup. You can apply settings from the backup file, keep actual settings, set it manually in a dialog box or apply DHCP.
- Step 5.** Press the **Start restore process** button and click on the **Yes** button when asked.
- Step 6.** Reboot the device to apply the network settings after finishing.

## 5.11. Advanced View Window

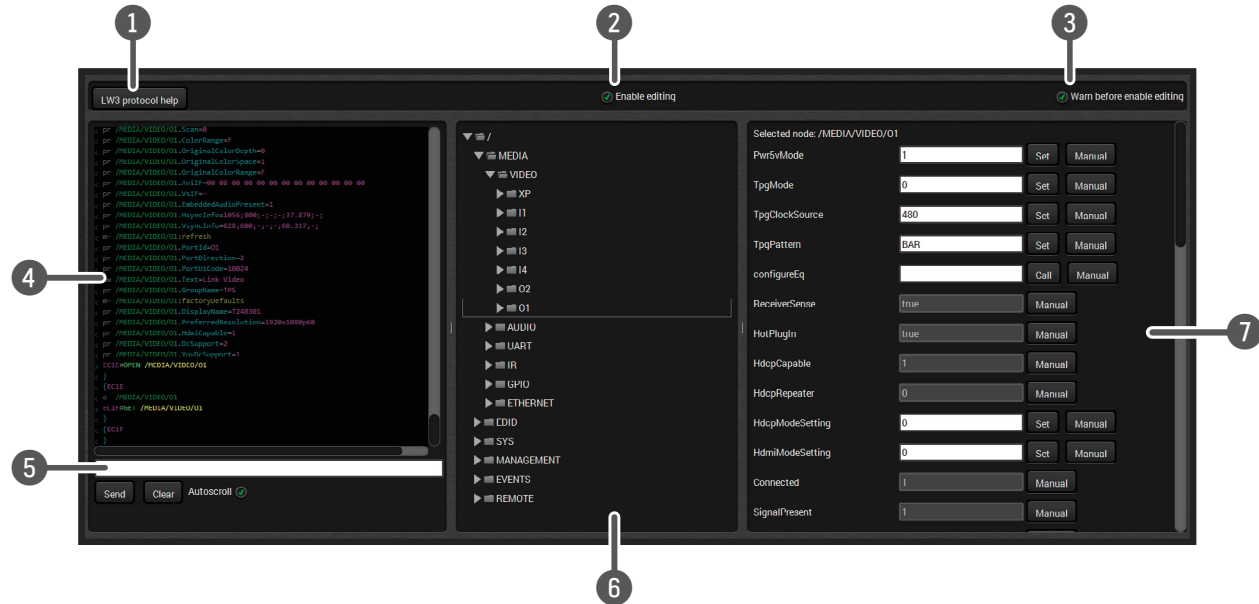

- 1 LW3 protocol help** Pushing the button results a help window opening which describes the most important information about LW3 protocol commands in HTML format.
- 2 Edit mode** The default appearance is the read-only mode. If you want to modify the values or parameters, tick the option. You will be prompted to confirm your selection.
- 3 Warning mode** If this pipe checked in, a warning window pops up when you enable Edit mode.
- 4 Terminal window** Commands and responses with time and date are listed in this window. Sent command starts with '>' character, received response starts with '<' character. The color of each item depends on the type of the command and response. The content of the window can be emptied by the **Clear** button. If the **Autoscroll** option is ticked, the list is scrolled automatically when a new line is added.
- 5 Command line** Type the desired command and execute it by the **Send** button. Clear all current commands and responses in the Terminal window by the **Clear** button.
- 6 Protocol tree** LW3 protocol tree; select an item to see its content.
- 7 Node list** Correspondent parameters and nodes are shown which are connected to the selected item in the protocol tree.
- Manual button:** Manual (short description) of the node can be called and displayed in the terminal window.
- Set button:** Saves the value/parameter typed in the textbox.
- Call button:** Calls the method, e.g. reloads factory default settings.

# 6

## LW2 Programmer's Reference

The device can be controlled through a reduced command set of LW2 protocol commands to ensure the compatibility with other Lightware products. The supported LW2 commands are described in this chapter.

- ▶ LW2 PROTOCOL DESCRIPTION
- ▶ GENERAL LW2 COMMANDS
- ▶ A/V PORT SETTINGS
- ▶ NETWORK CONFIGURATION
- ▶ GPIO CONFIGURATION
- ▶ LW2 COMMANDS – QUICK SUMMARY

### 6.1. LW2 Protocol Description

The device accepts commands surrounded by curly brackets - {} - and responds data surrounded by round brackets - () - only if a command was successfully executed.

Format	Explanation
<in>	Input number in 1 or 2 digit ASCII format (01, 5, 07, 16, etc.)
<out>	Output number in 1 or 2 digit ASCII format
<in <sup>2</sup> >	Input number in 2 digit ASCII format (01, 02, 10, 12 etc.)
<out <sup>2</sup> >	Output number in 2 digit ASCII format (01, 02, 10, 12 etc.)
<loc>	Location number in 1, 2 or 3 digit ASCII format
<id>	id number in 1 or 2 digit ASCII format
<id <sup>2</sup> >	id number in 2 digit ASCII format
CrLf	Carriage return, Line feed (0x0D, 0x0A)
•	Space character (0x20)
→	Each command issued by the controller
←	Each response received from the router

### 6.2. General LW2 Commands

#### 6.2.1. View Product Type

**Description:** The device responds its name.

Format	Example
Command {i} Response (I:<PRODUCT_TYPE>)CrLf	→ {i} ← (I:SW4-TPS-TX240)

**Explanation:** The connected device is a SW4-TPS-TX240.

**Legend:** <PRODUCT\_TYPE> shows type.

#### 6.2.2. Query Control Protocol

**Description:** The device can be controlled with different control protocols. This command queries the active protocol of the currently used control interface.

Format	Example
Command {P_?} Response (CURRENT•PROTOCOL•#<protocol>) CrLf	→ {p_?} ← (CURRENT PROTOCOL = #1)

**Explanation:** The device communicates with LW2 protocol.



### 6.2.3. View Firmware Version of the CPU

**Description:** View the CPU firmware revision.

Format	Example
Command {f} Response (FW:<FW_VER><s>)CrLf	→ {f} ← (FW:1.1.1b1 r3081)

**Legend:** <FW\_VER> is the firmware version. It is followed by <s> string which may indicate special versions.

### 6.2.4. Connection Test

**Description:** Simple test to see if the connection is established successfully.

Format	Example
Command {PING} Response (PONG!)CrLf	→ {ping} ← (PONG!)

### 6.2.5. View Serial Number

**Description:** The device responds its 8-digit serial number.

Format	Example
Command {s} Response (SN:<SERIAL_N>)CrLf	→ {s} ← (SN:5A003192)

### 6.2.6. Compile Time

**Description:** Returns the date, when the microcontroller firmware was compiled.

Format	Example
Command {CT} Response (Complied: <DATE&TIME>)CrLf	→ {ct} ← (Compiled: May 11 2016 11:01:27)

### 6.2.7. View Installed Board

**Description:** Shows the hardware name and revision of the installed card.

Format	Example
Command {is} Response (SL#●●●<MB_DESC>)CrLf (SL●END)CrLf	→ {is} ← (SL# 0 SW4-TPS-TX240 V12_DAA0) ← (SL END)

**Explanation:** The device reports its motherboard (slot 0).

### 6.2.8. View Firmware for All Controllers

**Description:** Shows the firmware versions of all installed controllers.

Format	Example
Command {FC} Response (CF●<DESC>)CrLf (CF●<DESC>)CrLf ... (CF END)CrLf	→ {fc} ← (CF SW4-TPS-TX240 1.1.1b1 r3081)   ← (SL END)

**Explanation:** The device has one control panel.

### 6.2.9. Restart the Device

**Description:** The device can be restarted without unplugging power.

Format	Example
Command {RST} Response	→ {rst}

**Explanation:** The device reboots; no response is sent in this case.

### 6.2.10. Query Health Status

**Description:** Internal voltages and measured temperature values are shown.

Format	Example
Command {ST} Response (ST●<DESC>)CrLf	→ {st} ← (ST CPU 11.61V 5.03V 1.84V 1.28V 0.99V 42.24C 42.23C)

### 6.2.11. Restore Factory Default Settings

**Description:** Settings can be reset to factory default values as follows:

Format	Example
Command {FACTORY=ALL} Response (FACTORY ALL...)CrLf	→ {factory=all} ← (FACTORY ALL...)

**Explanation:** All settings and parameters are reset to factory default, see the table in the [Factory Default Settings](#) section.

## 6.3. A/V Port Settings

### 6.3.1. Switch an Input to the Output

Following commands with <A/V/AV> option can take effect in multiple layers, according to their parameters. Depending on 'A' or 'V' it can change only the Audio or only the Video layer; or 'AV' changes both.

INFO: <A/V/AV> option usually can be skipped for legacy purposes. In this case, the devices change all (Video & Audio) layers but using status commands it displays information about only the Video layer. Please use AV option, when available.

**Description:** Switch input <in> to output <out>.

Format	Example
Command {<in>@<out>●<layer>} Response (O<out>²●<in>²●<layer>)CrLf	→ {2@1 AV} ← (001 I02 AV)

**Explanation:** I2 audio and I2 video input ports are switched to O1 output port.

**Legend:**

<layer>	Layer
A	Audio layer
V	Video layer
AV (or nothing)	Audio & Video layer

<out>: O1 output port.  
<in>: I1...I6 input ports.

**ATTENTION!** The response of this command does not show if the output is muted. To check the mute status a separate query has to be used like {VC}.

**ATTENTION!** Analog video inputs does not contain embedded audio. If you use the AV option in case of VGA input (I1) the audio will be switched to the analog audio input 1 (I1) and in case of DVI-A input (I5) the audio will be switched to the analog audio input 2 (I5).

### 6.3.2. Mute Output

**Description:** Mute output <out>. The output signal is turned off.

Format	Example
Command {#<out>●<layer>} Response (1MT<out>²●<layer>)CrLf	→ {#01 A} ← (1MT01 A)

**Explanation:** O1 audio port is muted.

**ATTENTION!** Muting does not change the crosspoint's state but disables the output itself. This way the last connection can be easily restored with an unmute command. Switching a muted output does not unmute the output.

### 6.3.3. Unmute Output

**Description:** Unmute output <out>.

Format	Example
Command {+<out>●<layer>} Response (0MT<out>²●<layer>)CrLf	→ {+01 V} ← (0MT01 V)

**Explanation:** O1 video port is unmuted.

INFO: Unmuting an output makes the previous connection active as the crosspoint state has not been changed by the muting command, only the output was disabled.

### 6.3.4. Lock Output

**Description:** Lock an output port. Output's state cannot be changed until unlocking.

Format	Example
Command {#<out>●<layer>} Response (1LO<out>²●<layer>)CrLf	→ {#>01 A} ← (1LO01 A)

**Explanation:** O1 audio output port is locked.

### 6.3.5. Unlock Output

**Description:** Unlock an output port. The connection on output can be changed.

Format	Example
Command {+<out>●<layer>} Response (0LO<out>²●<layer>)CrLf	→ {+<out> V} ← (0LO01 V)

**Explanation:** O1 video output port is unlocked.

INFO: The device issues the above response regardless of the previous state of the output (either it was locked or unlocked).

### 6.3.6. View Connection State on the Output

**Description:** Viewing the crosspoint state of the device; showing the input port numbers connected to the outputs.

Format	Example
Command {VC<layer>} Response (ALL<layer>●<001>●<002>)CrLf	→ {VC AV} ← (ALLV 02) ← (ALLA 05)

**Legend:** 001 shows the corresponding output's connection state.

<layer>	Layer
A	Audio layer
V	Video layer
AV *	Audio & Video layer

\* AV is not used in the response. When AV is typed in the commands, the response will result two lines, one for the Video and one for the Audio port states.

**State letters:**

Letter	State	Example
L	Output is locked	L01
M	Output is muted	M01
U	Output is locked and muted	U01

**Explanation:** I2 video input port is connected to the video output port and I5 audio input port is connected to the audio output port.

### 6.3.7. View Crosspoint Size

**Description:** Shows the physical crosspoint size.

Format	Example
Command {getsize●<layer>} Response (SIZE=<size>●<layer>)CrLf	→ {GETSIZE AV} ← (SIZE=6x1 V) ← (SIZE=5x1 A)

**Legend:**

<size>:            <number of inputs>x<number of outputs>  
<layer>:            See details in the previous section.

**Explanation:** The device reports that it has a video crosspoint with 6 inputs (Test pattern is the 6th input) and 1 output and an audio crosspoint with 5 inputs and 1 output.

### 6.3.8. Change Video Autoselect Mode

**Description:** The autoselect mode of the video outputs can be changed.

Format	Example
Command {AS_V<out>=<state>;<mode>} Response (AS_V<out>=<state>;<mode>)CrLf	→ {as_v1=E;P} ← (AS_V1=E;P) ← (AS_V2=E;P)

**Legend:** The output numbers are listed in [Port Numbering](#) section.

Letter	<state>
F	First detect mode
P	Priority detect mode
L	Last detect mode

Letter	<mode>
E	Autoselect mode is enabled
D	Autoselect mode is disabled

**Explanation:** The Autoselect mode of video output1 and output 2 is enabled and set to Priority mode.

INFO: The Autoselect mode can be queried by typing the "as\_v<out>=?" command.

### 6.3.9. Change Audio Autoselect Mode

**Description:** The autoselect mode of the audio outputs can be changed.

Format	Example
Command {AS_A<out>=<state>;<mode>} Response (AS_A<out>=<state>;<mode>)CrLf	→ {as_a1=E;P} ← (AS_A1=E;P) ← (AS_A2=E;P)

**Legend:** The output numbers are listed in [Port Numbering](#) section.

Letter	<state>
F	First detect mode
P	Priority detect mode
L	Last detect mode

Letter	<mode>
E	Autoselect mode is enabled
D	Autoselect mode is disabled

**Explanation:** The Autoselect mode of audio output1 and output 2 is enabled and set to Priority mode.

INFO: The Autoselect mode can be queried by typing the "as\_v<out>=?" command.

### 6.3.10. Change the Video Input Priorities

**Description:** The settings of video input priority can be changed as follows.

Format	Example
Command {PRIO_V<out>=<in <sup>1</sup> _prio>;<in <sup>2</sup> _prio>;...;<in <sup>n</sup> _prio>} Response (PRIO_V<out>=<in <sup>1</sup> _prio>;<in <sup>2</sup> _prio>;...;<in <sup>n</sup> _prio>)CrLf	→ {prio_v1=1;0;2;3} ← (PRIO_V1=1;0;2;3)

**Legend:**

<out>: The output port number: V1/V2.  
<in<sup>1</sup>\_prio>...<in<sup>n</sup>\_prio>: Priority number of the input ports. See more details about port numbering in the [Port Numbering](#) section.

**Explanation:** Input 2 has the highest priority (0), Input 1 has the second highest (1). Input 4 has the lowest priority (3).

**ATTENTION!** Always set all the priority of the ports when changing, otherwise, the change will not be executed and the response will be the current setting (like querying the priority setting).

**INFO:** In this case, the outputs are linked; the change will affect both local and fiber optical output ports.

**INFO:** The video priorities can be queried by typing the “prio\_v<out>=?” command.

### 6.3.11. Change Audio Input Priority

**Description:** The settings of video input priority can be changed as follows.

Format	Example
Command {PRIO_A<out>=<in <sup>1</sup> _prio>;<in <sup>2</sup> _prio>;...;<in <sup>n</sup> _prio>} Response (PRIO_A<out>=<in <sup>1</sup> _prio>;<in <sup>2</sup> _prio>;...;<in <sup>n</sup> _prio>)CrLf	→ {prio_a1=1;0;2;3;4} ← (PRIO_A1=1;0;2;3;4)

**Legend:**

<out>: The output port number: A1/A2.  
<in<sup>1</sup>\_prio>...<in<sup>n</sup>\_prio>: Priority number of the input ports. See more details about port numbering in the [Port Numbering](#) section.

**Explanation:** Input 2 has the highest priority (0), Input 1 has the second highest (1). Input 5 has the lowest priority (4).

**ATTENTION!** Always set all the priority of the ports when changing, otherwise, the change will not be executed and the response will be the current setting (like querying the priority setting).

**INFO:** In this case, the outputs are linked; the change will affect both local and fiber optical output ports.

**INFO:** The audio priorities can be queried by typing the “prio\_a<out>=?” command.

## 6.4. Network Configuration

### 6.4.1. Query the Current IP Status

**Description:** IP address settings can be queried as follows.

Format	Example
Command {IP_STAT=?} Response (IP_STAT=<type>;<ip_address>;<subnet_mask>;<gateway_addr>)CrLf	→ {ip_stat=?} ← (IP_STAT=0;192.168.0.100;255.255.255.0;192.168.0.1)

**Legend:**

<type>: 0 = static IP; 1 = DHCP.  
<ip\_addr>: IP address (four decimal octets separated by dots).  
<subnet\_mask>: Subnet mask (four decimal octets separated by dots).  
<gateway\_addr>: Gateway address (four decimal octets separated by dots).

**Explanation:** The device has a static (fix) IP address: 192.168.0.100; the subnet mask is 255.255.255.0, the gateway address is 192.168.0.1.

### 6.4.2. Set the IP Address

**Description:** IP address can be set as follows.

Format	Example
Command {IP_ADDRESS=<type>;<ip_address>} Response (IP_ADDRESS=<type>;<ip_address>)CrLf	→ {ip_address=0;192.168.0.110} ← (IP_ADDRESS=0;192.168.0.110)

**Legend:** <type>: 0 = static IP; 1 = DHCP

**INFO:** The IP address can be queried by typing the “ip\_address=?” command. The response contains the fix IP address that is stored in the device even if DHCP is enabled; in this case, this IP address is not valid.

### 6.4.3. Set the Subnet Mask

**Description:** Subnet mask can be set as follows.

Format	Example
Command {IP_NETMASK=<subnet_mask>} Response (IP_NETMASK=<subnet_mask>)CrLf	→ {ip_netmask=255.255.255.0} ← (IP_NETMASK=255.255.255.0)

**Legend:** <subnet\_mask>: Four decimal octets separated by dots.

**INFO:** The subnet mask can be queried by typing the “ip\_address=?” command. The response contains the fix IP subnet mask that is stored in the device even if DHCP is enabled; in this case, this IP subnet mask is not valid.

#### 6.4.4. Set the Gateway Address

**Description:** Gateway address can be set as follows.

Format	Example
Command {IP_GATEWAY=<gateway_addr> Response (IP_GATEWAY=<gateway_addr>)CrLf	→ {ip_gateway=192.168.0.50} ← (IP_GATEWAY=192.168.0.50)

**Legend:** <gateway\_addr>: Four decimal octets separated by dots.

**INFO:** The gateway address can be queried by typing the "ip\_gateway=?" command. The response contains the static IP gateway address that is stored in the device even if DHCP is enabled. In that case, the latest valid gateway address (for static IP) is stored.

#### 6.4.5. Apply Network Settings

**Description:** Apply the network settings and restart the network interface.

Format	Example
Command {ip_apply} Response (IP_APPLY)CrLf	→ {ip_apply} ← (IP_APPLY)

### 6.5. GPIO Configuration

#### 6.5.1. Set Level and Direction for Each Pins

**Description:** GPIO pins can be configured as follows. See more details about GPIO connector in the section and about the interface in the section.

Format	Example
Command {GPIO<pin_nr>=<dir>;<level>} Response (GPIO<pin_nr>=<dir>;<level>)CrLf	→ {gpio1=0;H} ← (GPIO1=0;H)

**Legend:**

- <pin\_nr>: GPIO pin number 1...8
- <dir>: The direction of the communication, it can be input or output.
- <level>: The level of the pin, it can be low or high.

Parameter <dir>	Description
I	Input
O	Output

Parameter <level>	Description
L	Low
H	High
T	Toggle

**Explanation:** GPIO pin 1 is set to output with high level.

**INFO:** The current GPIO pin configuration can be queried by typing the {GPIO<pin\_nr>=?} command.



## 6.6. LW2 Commands – Quick Summary

### General LW2 Commands

Operation	See in section	Command
View Product Type	6.2.1	{I}
Query Control Protocol	6.2.2	{P_?}
View Firmware Version of the CPU	6.2.3	{F}
Connection Test	6.2.4	{PING}
View Serial Number	6.2.5	{S}
Compile Time	6.2.6	{CT}
View Installed Board	6.2.7	{IS}
View Firmware for All Controllers	6.2.8	{FC}
Restart the Device	6.2.9	{RST}
Query Health Status	6.2.10	{ST}
Restore Factory Default Settings	6.2.11	{FACTORY=ALL}

### A/V Port Settings

Operation	See in section	Command
Switch an Input to the Output	6.3.1	{<in>@<out>●<layer>}
Mute Output	6.3.2	{#<out>●<layer>}
Unmute Output	6.3.3	{+<out>●<layer>}
Lock Output	6.3.4	{#><out>●<layer>}
Unlock Output	6.3.5	{+<out>●<layer>}
View Connection State on the Output	6.3.6	{VC●<layer>}
View Crosspoint Size	6.3.7	{GETSIZE●<layer>}
Change Video Autoselect Mode	6.3.8	{AS_V<out>=<state>;<mode>;<no_signal>}
Change Audio Autoselect Mode	6.3.9	{AS_A<out>=<state>;<mode>;<no_signal>}
Change the Video Input Priorities	6.3.10	{PRIO_V<out>=<in_1_prio>;...;<in_n_prio>}
Change Audio Input Priority	6.3.11	{PRIO_A<out>=<in_1_prio>;...;<in_n_prio>}

### Network Configuration

Operation	See in section	Command
Query the Current IP Status	6.4.1	{IP_STAT=?}
Set the IP Address	6.4.2	{IP_ADDRESS=<type>;IP_ADDRESS}
Set the Subnet Mask	6.4.3	{IP_NETMASK=<subnet_mask>}
Set the Gateway Address	6.4.4	{IP_GATEWAY=<gateway_address>}
Apply Network Settings	6.4.5	{IP_APPLY}

### GPIO Configuration

Operation	See in section	Command
Set Level and Direction for Each Pins	6.5.1	{GPIO<pin_nr>=<dir>;<level>}

# 7

## LW3 Programmer's Reference

The device can be controlled through Lightware 3 (LW3) protocol commands to ensure the compatibility with other Lightware products. The supported LW3 commands are described in this chapter.

- ▶ OVERVIEW
- ▶ THE TREE STRUCTURE OF THE TRANSMITTER
- ▶ LW3 COMMANDS
- ▶ FORMAL DEFINITIONS
- ▶ SYSTEM COMMANDS
- ▶ VIDEO PORT SETTINGS
- ▶ AUDIO PORT SETTINGS
- ▶ NETWORK CONFIGURATION
- ▶ RS-232 PORT CONFIGURATION
- ▶ INFRARED PORT CONFIGURATION
- ▶ SENDING MESSAGE VIA THE COMMUNICATION PORTS
- ▶ GPIO PORT CONFIGURATION
- ▶ EDID MANAGEMENT
- ▶ LW3 COMMANDS - QUICK SUMMARY

### 7.1. Overview

Lightware 3 (LW3) protocol is used by the 25G hybrid matrix, the MODEX family and the new series of Lightware TPS and OPT products, including the HDMI-TPS-TX200 series transmitters. The protocol (LW3) is ASCII-based and all commands are terminated with a carriage return (Cr, '\r') and line feed (Lf, '\n') pair. It is organized as a tree structure that provides outstanding flexibility for implementing a human readable, but programmatically still ease to parse, which is suitable for different products with a different feature list.

In order to implement a flexible, easy-to-use protocol that is straightforward to adapt to new devices and provides outstanding scalability and sustainability, we decided to organize all settings, parameters and properties of the device to a tree structure with 'nodes', 'properties' and 'methods'.

#### 7.1.1. Elements of the Tree Structure

**ATTENTION!** All names and values are case-sensitive. The space character is replaced by the '•' character in the elements and commands descriptions.

##### 7.1.1.1. Node

- The basic building block of the tree structure is the 'node'.
- The node can have multiple child nodes, but only one parent.
- The tree has only one root the 'root node'.
- The leaves of the tree are also nodes, which do not have child nodes.
- The nodes are separated by a slash ('/') character.
- All the slashes are 'right slashes', no backslash is used.
- The identifier of the root node is a slash ('/')
- The node name can contain the elements of the English alphabet and numbers.
- Recommended convention for case sensitivity:
  - Fix nodes (that cannot be altered) are capitalized.
  - User created nodes can contain both lowercase and capital letters, no restrictions.
- The path of a node has to contain all parent nodes from the root node.

**Format:** (the root node): nX•/

**Path:** nX•/[nodeName]/[nodeName]/[nodeName]

**Legend:**

n:	node
'X' can be:	
':':	default for a node.
'm':	this is a manual for the node.
'E':	this is an error message for the node.
's':	this is a symlink node.
'v':	this node has virtual children.
'r':	this is a remote node.

**INFO:** All parent nodes must be listed in the path of a node.

Following example presents the structure of the tree traversal:

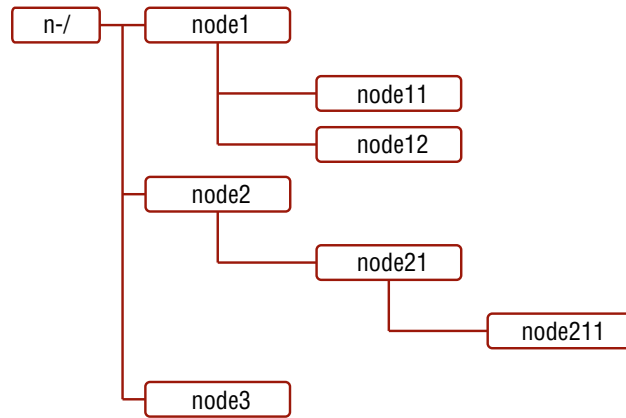

**Tree structure of the nodes**

**Path of the nodes:**

```

n- /node1
n- /node1/node11
n- /node1/node12
n- /node2
n- /node2/node21
n- /node2/node21/node211
n- /node3
  
```

### 7.1.1.2. Property

The 'property' in the LW3 protocol is basically a leaf, which has a well-defined value.

- A property has a value.
- A property cannot have child nodes or child properties. It is always a leaf.
- A node can have any number of properties (may not have any).
- A property is referenced with a dot ('.') after the node name.
- The properties' name can contain the elements of the English alphabet, numbers and underscore ('\_') character.
- By convention, properties are beginning with a capital letter, all other characters are lowercase ones. In the case of compound words, all words are beginning with a capital letter (CamelCase).
- The value of the property can contain any readable ASCII character.
- A property can be read-only or read/write.

**Format:** pX●/[nodeName].[propertyName]=[propertyValue]

**Legend:**

p: property  
 'X' can be:  
 'r': if the property is read-only.  
 'w': if the property is readable, writable.  
 'm': the manual of the property.  
 'E': error message for the property.  
 'v': virtual node property: contains a node path to a node which will be linked to the property's parent node.

**Example:**

The following two ones are read-only properties:

```

pr●/node1/node12.ReadOnlyProperty=value1
pr●/.DeviceName=25G Hybrid Device
  
```

The following two ones are read-write properties:

```

pw●/node1/node12.ReadWriteProperty=value2
pw●/.DeviceNickName=John
  
```

### 7.1.1.3. Method

The 'method' in the LW3 protocol is also a leaf. It cannot have a value, such as the properties, but it can be invoked with a parameter with the help of a special 'CALL' command.

- A method cannot have child nodes or child methods. It is always a leaf.
- A node can have any number of methods (may not have any).
- A method is referenced with a colon (':') after the node.
- The methods' name can contain the elements of the English alphabet, numbers and underscore ('\_') character.
- By convention, methods are beginning with lowercase letter. In case of compound words, the very first letter is lowercase, and the first letter of each other words are capitalized (lowerCamelCase).
- The parameter of the method can contain any readable ASCII character.
- The method always has a return 'state' if the method could be executed. The state could be either 'OK' or 'FAILED'.
- The method does not necessarily have a return 'value'. If it does, it can contain additional information, which is always specific to the current case (the return value can specify why the execution failed).
- When the method cannot be executed (e.g. the parameter list is illegal), there is an error message.

**Format:** mX●/[nodeName]:[methodName]=[returnValue]

**Legend:**

m: method  
 'X' can be:  
 'O': when the execution of the method was successful (OK).  
 'F': when the execution of the method failed.  
 'm': the manual of the method.  
 'E': error message for the method.

**Example:**

```

mO●/node1/node12:method1
mO●/MEDIA/VIDEO/XP:switch
mE●%E001:Syntax error
mm●/MEDIA/VIDEO/XP:lockSource:Lock one or more source ports
  
```

### 7.1.2. Escaping

Property values and method parameters can contain characters that are used as control characters in the protocol. They must be escaped. The escape character is the backslash ('\') and escaping means injecting a backslash before the character that should be escaped (like in C language).

Control characters are the followings: \ { } # % ( ) \r \n \t

#### Example:

The original text: John•(Doe).•#3:•5%2=1•node1\node11

The escaped text: John•\ (Doe\).•\#3:•5\%2=1•node1\\node11

### 7.1.3. Error Messages

There are several error messages defined in the LW3 protocol, all of them have a unique error number.

**Format:** XE•[primitive]•%EYYY:•[Error message]

#### Legend:

'X' can be:

'-': syntax error. Cannot parse the command at all.

'n': node error.

'p': property error.

'm': method error.

YYY: error code, which can be one of the followings:

YYY: error code	Name	Default text
000	Lw3ErrorCodes_None	
001	Lw3ErrorCodes_Syntax	Syntax error
002	Lw3ErrorCodes_NotFound	Not found
003	Lw3ErrorCodes_AlreadyExists	Already exists
004	Lw3ErrorCodes_InvalidValue	Invalid value
005	Lw3ErrorCodes_IllegalParamCount	Illegal parameter count
006	Lw3ErrorCodes_IllegalOperation	Illegal operation
007	Lw3ErrorCodes_AccessDenied	Access denied
008	Lw3ErrorCodes_Timeout	Timeout
009	Lw3ErrorCodes_CommandTooLong	Command too long
010	Lw3ErrorCodes_InternalError	Internal error
011	Lw3ErrorCodes_NotImplemented	Not implemented

### 7.1.4. Prefix Summary

The following prefixes are defined in the LW3 protocol:

'n-': a node,

'nE': an error for a node,

'nm': a manual for a node,

'pr': a read-only property,

'pw': read-write property,

'pE': an error for the property,

'pm': a manual for the property,

'm-': a method,

'mO': a response after a success method execution,

'mF': a response after a failed method execution,

'mE': an error for a method,

'mm': a manual for a method.

## 7.2. The Tree Structure of the Transmitter

INFO: The tree structure is available in the [Advanced View Window](#) of LDC.

The /MEDIA node is used by the LDC to connect input ports to output ports on different layers. Each subnode of /MEDIA is representing a layer, e.g. video (/MEDIA/VIDEO), audio (/MEDIA/AUDIO) or RS-232 (/MEDIA/UART). Each layer has a crosspoint to define connections between the ports associated with the layer, all of them are represented by a specific node. E.g. the video layer node is /MEDIA/VIDEO: under the video layer node, the video crosspoint node (XP) and the video ports (I1, I2, ...) are located.

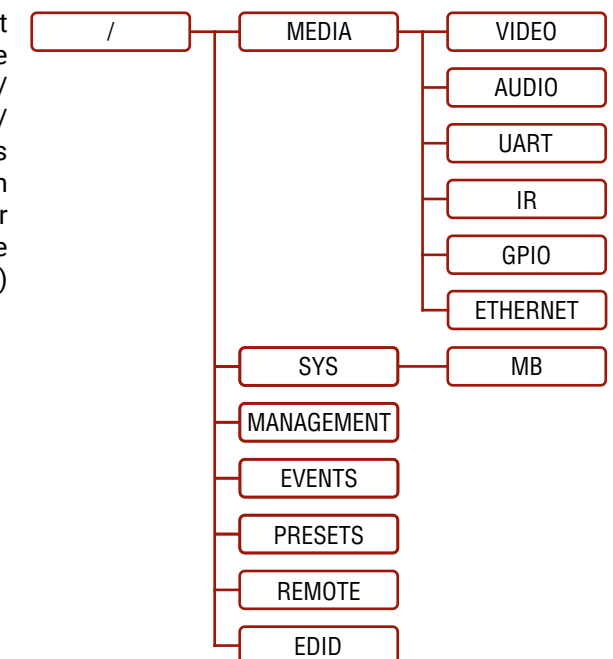

## 7.3. LW3 Commands

### 7.3.1. Get Command

The 'GET' command can be used to get the child nodes, properties and methods of a specific node. It can also be used to get the value of a property.

#### The Response Format

The first two characters of a response unambiguously identify the type of the element that the response line concerns. The first character is the type of the element (node, property or method), the second is for miscellaneous information (e.g. read/write rights).

The defined prefixes are:

'n':	node
'pr':	property - only readable
'pw':	property - writable, readable
'm':	method executable

After the prefix, the response contains the full path of the node, property or method after a space character.

#### Get All Children of a Node

Get all of the child nodes of a parent node, with one GET command.

**Command format:** GET●[nodePath]

**Response format:** n-●[nodePath]

**Example:**

```
> GET /MEDIA
< n- /MEDIA/VIDEO
< n- /MEDIA/AUDIO
< n- /MEDIA/UART
< n- /MEDIA/IR
< n- /MEDIA/GPIO
< n- /MEDIA/ETHERNET
```

#### Get All Properties and Methods of a Node

Get all properties and methods of a node, with one GET command and asterisk character.

**Command format:** GET●[nodePath].\*

**Response format:** (for properties)

pX●[nodePath].[propertyName]=[parameter]

**Legend:**

X can be:	
'r':	read-only
'w':	read-write

**Response format:** (for methods)

m-●[nodePath]:[methodName]

**Example:**

```
> GET /EDID.*
< pr /EDID.EdidStatus=D1:E1;D1:E2;D1:E3;D1:E4
< m- /EDID:switch
< m- /EDID:switchAll
< m- /EDID:copy
< m- /EDID:delete
< m- /EDID:reset
```

#### Get All Child Nodes, Properties and Methods of a Node

Get all child nodes, properties and methods of a node with one command, without using a wild card.

**Command format:** GETALL●[nodePath]

**Response format:** (for nodes)

n-●[nodePath]

**Response format:** (for properties)

pX●[nodePath].[propertyName]=[parameter]

**Legend:**

X can be:	
'r':	read-only
'w':	read-write

**Response format:** (for methods)

m-●[nodePath]:[methodName]



**Example:**

```
> GETALL /EDID
< n- /EDID/F
< n- /EDID/D
< n- /EDID/U
< n- /EDID/E
< pr /EDID.EdidStatus=D1:E1;D1:E2;D1:E3;D1:E4
< m- /EDID:switch
< m- /EDID:switchAll
< m- /EDID:copy
< m- /EDID:delete
< m- /EDID:reset
```

**7.3.2. Set Command**

The setter command can be used to modify the value of a property.

**Command format:** SET●[nodePath].[propertyName]=[newPropertyValue]

**Response format:**

The response for setting a property to a new value is the same as the response for the 'GET' command. The value in the response is the new value if the execution of the 'SET' command was successful, otherwise the unmodified 'old value' with an error message.

pw●[nodePath].[propertyName]=[newPropertyValue]

**Example:**

```
> SET /SYS/MB/RS232/LOCAL.Rs232Mode=1
< pw /SYS/MB/RS232/LOCAL.Rs232Mode=1
```

**Error response format:**

If there were errors during setting a property, an error message follows the unmodified property value.

pE●[nodePath].[propertyName]=[unmodifiedValue]●%EXXX:Error message

**Legend:** XXX: error number.

**Examples:**

```
> SET /SYS/MB/RS232/LOCAL.Rs232Mode=11
< pE /SYS/MB/RS232/LOCAL.Rs232Mode %E005:Invalid value
```

```
> SET /SYS/MB/RS232/LOCAL.ActiveProtocol=LW3
< pE %E004:Writing read-only property
```

**7.3.3. Invocation**

A method can be invoked with the help of the 'CALL' command.

**Command format:** CALL●[nodePath]:[methodName]([parameter])

**Response format:**

The response for a method execution is a state and a value. The state is mandatory and always defined if the method could be executed. It can be either a success or a failure. The value is optional and it can contain additional information, such as the reason why the state is a failure or a specific value when the state is success that the client can process. It is also possible to get an error message when the method could not be executed – e.g. the parameter was illegal - and hence not even the state of the execution could be specified.

mX●[nodePath]:[methodName]=Y

**Legend:**

X can be:

'O': if the execution is successful.  
 'F': if the execution is failed, but the method could be executed.  
 'E': if the method could not be executed: e.g. illegal parameter count.

Y can be:

- The return value of the method if any.
- It is valid that a method does not have any return value. In this case, the equal sign ('=') can be omitted.

**Example:**

```
> CALL /EDID:switch(D1:E1)
< mO /EDID:switch
```

**Error response format:**

If there were errors during the execution, an error message is received, which follows the method name.

mE●[nodePath]:[methodName]●%EXXX:Error message

**Example:**

```
> CALL /EDID:switch(D1:R1)
< mE %E001:Syntax error
```

### 7.3.4. Manual

For every node, property and method in the tree there is a manual. The manual is a human readable text that describes the syntax and provides a hint for how to use the primitives.

#### Command format:

for nodes:           MAN●[nodePath]  
for property:        MAN●[nodePath].[propertyName]  
for method:         MAN●[nodePath]:[methodName]

#### Response format:

The human readable manual is separated by a space ( ' ') character from the primitives.

for nodes:           nm●[nodePath]●Human readable manual  
for property:        pm●[nodePath].[propertyName]●Human readable manual  
for method:         mm●[nodePath]:[methodName]●Human readable manual

**Example:** (for a property)

```
> MAN /SYS/MB/RS232/LOCAL.ActiveProtocol
< pm /SYS/MB/RS232/LOCAL.ActiveProtocol ["LW2" | "LW3"] Active Protocol
```

**Example:** (for a method)

```
> MAN /SYS/MB/RS232/LOCAL:factoryDefaults
< mm /SYS/MB/RS232/LOCAL:factoryDefaults [] Restore factory default settings
```

### 7.3.5. Signature

For some command, the response can contain multiple lines. Each line is terminated with a carriage return (Cr, '\r') and line feed (Lf, '\n') characters. In several cases the number of the lines in the response cannot be determined in advance, e.g. the client is intended waiting for the whole response and also wants to be sure, that the received lines belong together and to the same command. In these cases, a special feature the 'signature' can be used.

The signature is a four digit long hexadecimal value that can be optionally placed before every command. In that case, the response to that particular command will also be preceded by the signature, and the corresponding lines will be between brackets.

**Command format:**   XXXX#[command]

**Legend:**        xxxx: 4-digit long hexadecimal value.

#### Response format:

```
{XXXX
[command lines]
}
```

#### Example:

```
> 1103#GET /MEDIA/UART.*
< {1103
< pr /MEDIA/UART.PortCount=1
< pr /MEDIA/UART.PortUI=P1:12209
< pr /MEDIA/UART.P1=Local
< }
```

INFO: The lines of the signature are also Cr and Lf terminated.

### 7.3.6. Subscription

A user can subscribe to any node. Subscribe to a node means that the user will get a notification if any of the properties of the node is changed. These notifications are asynchronous messages - such as the ones described above - and hence, they are useful to keep the client application up-to-date, without receiving any unwanted information. When the user does not want to be informed about the changes anymore, he can simply unsubscribe from the node.

**ATTENTION!** The subscriptions are handled separately for connections. Hence, if the connection is terminated all registered subscriptions are deleted. After closing a connection the subscribe command has to be sent in order to get the notifications of the changes on that connection.

#### Subscribe to a Node

**Command format:**   OPEN●[nodePath]

**Response format:**  o-●[nodePath]

#### Example:

```
> OPEN /MEDIA/VIDEO
< o- /MEDIA/VIDEO
```

#### Subscribe to Multiple Nodes

In order to subscribe to multiple nodes, the asterisk wild card can be used.

**Command format:**   OPEN●[nodePath]/\*

**Response format:**  o-●[nodePath]/\*

#### Example:

```
> OPEN /MEDIA/VIDEO/*
< o- /MEDIA/VIDEO/*
```

**Get the Active Subscriptions for the Current Connection****Command format:** OPEN**Response format:** o-●[nodePath]**Example:**

```
> OPEN
< o- /MEDIA/VIDEO
< o- /EDID
< o- /LOG
```

**Unsubscribe from a Node****Command format:** CLOSE●[nodePath]**Response format:** c-●[nodePath]**Example:**

```
> CLOSE /MEDIA/VIDEO
< c- /MEDIA/VIDEO
```

**Unsubscribe from Multiple Nodes****Command format:** CLOSE●[nodePath]/\***Response format:** c-●[nodePath]/\***Example:**

```
> CLOSE /MEDIA/VIDEO/*
< c- /MEDIA/VIDEO/*
```

**7.3.7. Notifications about the Changes of the Properties**

When the value of a property is changed and the user is subscribed to the node, which the property belongs to, an asynchronous notification is generated. This notification is called as the 'change message'. The format of such a message is very similar to the response for the 'GET' command.

**Format:** CHG●[nodePath].[propertyName]=[newPropertyValue]**Example:**

```
< CHG /EDID.EdidStatus=F48:E1;F49:E2;F48:E3;F48:E4
```

**A Short Example of How to Use the Subscription**

In the following, an example is presented, how the subscriptions are working and how to use them. In the example, there are two independent users controlling the device through two independent connections ('Connection #1' and 'Connection #2'). The events in the rows occur after each other.

```

Connection #1 > OPEN /MEDIA/VIDEO/XP
               < o- /MEDIA/VIDEO/XP
               > GET /MEDIA/VIDEO/XP.DestinationConnectionList
               < pr /MEDIA/VIDEO/XP.DestinationConnectionList=I1
               > GET /MEDIA/VIDEO/XP.DestinationConnectionList
Connection #2 < pr /MEDIA/VIDEO/XP.DestinationConnectionList=I1
               > CALL /MEDIA/VIDEO/XP:switch(I1:O1)
               < mO /MEDIA/VIDEO/XP:switch
Connection #1 < CHG /MEDIA/VIDEO/XP.DestinationConnectionList=I1

```

**Explanation:** The first user (Connection #1) set a subscription to a node. Later the other user (Connection #2) made a change, and thanks for the subscription, the first user got a notification about the change.

**7.4. Formal Definitions**

Method parameters and property values are specified in a modified version of Backus Naur Form (BNF). The syntax is the following:

"literal"	literals are quoted
<expression1> <expression2>	vertical bars denote alternatives
[<expression>]	expressions in square brackets are optional
<number>*<expression>	expression is repeated at least <number> times
*<expression>	<number> may be omitted, in this case number defaults to 0
<number>*<expression>	expressions in curly brackets are repeated exactly <number> times
In	Input port number
Om	Output port number

## 7.5. System Commands

### 7.5.1. Query the Product Name

The name of the product is a read-only parameter and cannot be modified.

**Command format:** GET●/.ProductName

**Response format:** pr●/.ProductName=<Product\_name>

**Example:**

```
> GET /.ProductName
< pr /.ProductName=DP-TPS-TX210
```

### 7.5.2. Set the Device Label

**ATTENTION!** The device label can be changed to a custom text in the [Status](#) tab of the LDC software. This writable parameter is not the same as the ProductName parameter.

**Command format:** SET●/MANAGEMENT/UID/DeviceLabel=<Custom\_name>

**Response format:** pw●/MANAGEMENT/UID/DeviceLabel=<Custom\_name>

The Device Label can be 39 character length and ASCII characters are allowed. Longer names are truncated.

**Example:**

```
> SET /MANAGEMENT/UID.DeviceLabel=DP-TPS_Control_room
< pw /MANAGEMENT/UID.DeviceLabel=DP-TPS_Control_room
```

### 7.5.3. Query the Serial Number

**Command format:** GET●/.SerialNumber

**Response format:** pr●/.SerialNumber=<serial\_nr>

**Example:**

```
> GET /.SerialNumber
< pr /.SerialNumber=87654321
```

### 7.5.4. Query the Firmware Version

**Command format:** GET●/SYS/MB.FirmwareVersion

**Response format:** pr●/SYS/MB.FirmwareVersion=<firmware\_version>

```
> GET /SYS/MB.FirmwareVersion
< pr /SYS/MB.FirmwareVersion=1.1.1b1 r3081
```

### 7.5.5. Resetting the Device

The transmitter can be restarted – the current connections (LAN, RS-232) will be terminated.

**Command format:** CALL●/SYS:reset()

**Response format:** mO●/SYS:reset=

**Example:**

```
> CALL /SYS:reset()
< mO /SYS:reset=
```

### 7.5.6. Restore the Factory Default Settings

**Command format:** CALL●/SYS:factoryDefaults()

**Response format:** mO●/SYS:factoryDefaults=

**Example:**

```
> CALL /SYS:factoryDefaults()
< mO /SYS:factoryDefaults=
```

The device is restarted, current connections are terminated, and the default settings are restored. See the complete list in the [Factory Default Settings](#) section.

## 7.6. Video Port Settings

INFO: Video port numbering can be found in the [Port Numbering](#) section.

### 7.6.1. Query the Status of Source Ports

**Command format:** GET●/MEDIA/VIDEO/XP.SourcePortStatus

**Response format:** pr●/MEDIA/VIDEO/XP.SourcePortStatus=<I<sub>1</sub>>;<I<sub>2</sub>>;...;<I<sub>n</sub>>

The response contains 5 ASCII characters for each port. The first character indicates the mute/lock state, the next four characters represent a 2-byte HEX code showing the current state of the input ports.

**Example:**

```
> GET /MEDIA/VIDEO/XP.SourcePortStatus
< pr /MEDIA/VIDEO/XP.SourcePortStatus=T00FF;T00EF;T00AA;T00EF
```

**Legend:**

Letter (Character 1)		
	Mute state	Lock state
T	Unmuted	Unlocked
L	Unmuted	Locked
M	Muted	Unlocked
U	Muted	Locked

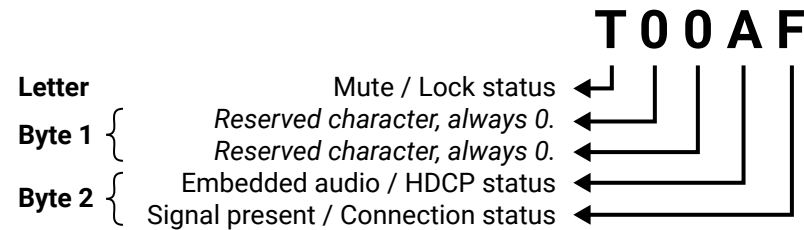

	Byte 1				Byte 2			
	Character 2		Character 3		Character 4		Character 5	
	BIT 7-6	BIT 5-4	BIT 3-2	BIT 1-0	BIT 7-6	BIT 5-4	BIT 3-2	BIT 1-0
	Reserved	Reserved	Reserved	Reserved	Embedded audio status	HDCP status	Signal present status	Connection status
00					Unknown			
01					Reserved			
10	Reserved	Reserved	Reserved	Reserved	No embedded audio	Not encrypted	No signal	Not connected
11					Embedded audio presents	Encrypted	Signal presents	Connected

**Example and Explanation (for input 2, T00EF):**

T	O		O		E		F	
Unlocked, Unmuted	00	00	00	00	11	10	11	11
	Reserved	Reserved	Reserved	Reserved	Embedded audio presents	Not encrypted	Signal presents	Connected

### The Most Common Received Port Status Responses

T00AA	T	O		O		A		A	
	Unlocked, Unmuted	00	00	00	00	10	10	10	10
	Reserved	Reserved	Reserved	Reserved	No embedded audio	Not encrypted	No signal	Not connected	

T00AB	T	O		O		A		B	
	Unlocked, Unmuted	00	00	00	00	10	10	10	11
	Reserved	Reserved	Reserved	Reserved	No embedded audio	Not encrypted	No signal	Connected	

T00AF	T	O		O		A		F	
	Unlocked, Unmuted	00	00	00	00	10	10	11	11
	Reserved	Reserved	Reserved	Reserved	No embedded audio	Not encrypted	Signal presents	Connected	

T00EF	T	O		O		E		F	
	Unlocked, Unmuted	00	00	00	00	11	10	11	11
	Reserved	Reserved	Reserved	Reserved	Embedded audio presents	Not encrypted	Signal presents	Connected	

T00BF	T	O		O		B		F	
	Unlocked, Unmuted	00	00	00	00	10	11	11	11
	Reserved	Reserved	Reserved	Reserved	No embedded audio	Encrypted	Signal presents	Connected	

T00FF	T	O		O		F		F	
	Unlocked, Unmuted	00	00	00	00	11	11	11	11
	Reserved	Reserved	Reserved	Reserved	Embedded audio presents	Encrypted	Signal presents	Connected	



### 7.6.2. Query the Status of Destination Port

**Command format:** GET●/MEDIA/VIDEO/XP.DestinationPortStatus

**Response format:** pr●/MEDIA/VIDEO/XP.DestinationPortStatus=[<O<sub>n</sub>>]

The response contains 5 ASCII characters for each port. The first character indicates the mute/lock state, the next 2-byte long HEX code showing the current state of the output ports.

**Example:**

```
> GET /MEDIA/VIDEO/XP.DestinationPortStatus
< pr /MEDIA/VIDEO/XP.DestinationPortStatus=M00BF;T00EF
```

**Legend:** See at previous section.

**Example and Explanation (for output 1, M00BF):**

M	0		0		B		F	
Unlocked, Muted	00	00	00	00	10	11	11	11
	Reserved	Reserved	Reserved	Reserved	No embedded audio	Encrypted	Signal presents	Connected

### 7.6.3. Query the Video Crosspoint Setting

**Command format:** GET●/MEDIA/VIDEO/XP.DestinationConnectionList

**Response format:** pr●/MEDIA/VIDEO/XP.DestinationConnectionList=<I<sub>n</sub>>

**Legend:**

<I<sub>n</sub>>: Video input port number

**Example:**

```
> GET /MEDIA/VIDEO/XP.DestinationConnectionList
< pr /MEDIA/VIDEO/XP.DestinationConnectionList=I1
```

**Explanation:** I1 input port is connected to the output port.

### 7.6.4. Switching Video Input

**Command format:** CALL●/MEDIA/VIDEO/XP:switch(<I<sub>n</sub>>:<O<sub>m</sub>>)

**Response format:** mO●/MEDIA/VIDEO/XP:switch

**Example:**

```
> CALL /MEDIA/VIDEO/XP:switch(I2:O1)
< mO /MEDIA/VIDEO/XP:switch
```

**Explanation:** I2 port is connected to O1 port.

### 7.6.5. Query the Video Autoselect Settings

**Command format:** GET●/MEDIA/VIDEO/XP.DestinationPortAutoselect

**Response format:** pr●/MEDIA/VIDEO/XP.DestinationPortAutoselect=<O<sub>n</sub>\_set>

The response shows the settings of each output one by one.

**Legend:**

<O<sub>n</sub>\_set> Two-letter code of the Autoselect settings:

Letter	Explanation	
1 <sup>st</sup> letter	E:	Autoselect is <b>enabled</b> .
	D:	Autoselect is <b>disabled</b> .
2 <sup>nd</sup> letter	F:	<b>First</b> detect mode: the first active video input is selected.
	P:	<b>Priority</b> detect mode: always the highest priority active video input will be selected.
	L:	<b>Last</b> detect mode: always the last attached input is switched to the output automatically.

**Example:**

```
> GET /MEDIA/VIDEO/XP.DestinationPortAutoselect
< pr /MEDIA/VIDEO/XP.DestinationPortAutoselect=EL
```

**Explanation:**

EL: the Autoselect is Enabled on output, selected mode is Last detect.

INFO: For more information about the Autoselect feature see [The Autoselect Feature](#) section.

### 7.6.6. Change the Autoselect Mode

**Command format:** CALL●/MEDIA/VIDEO/XP:setDestinationPortAutoselect(<O<sub>n</sub>>:<O<sub>n</sub>\_set>)

**Response format:** mO●/MEDIA/VIDEO/XP:setDestinationPortAutoselect

**Legend:** see previous section.

**Example1:**

```
> CALL /MEDIA/VIDEO/XP:setDestinationPortAutoselect(O1:EPM)
< mO /MEDIA/VIDEO/XP:setDestinationPortAutoselect
```

**Explanation1:** The setting is changed to "EPM": Autoselect is enabled (E); the mode is set to "priority detect" (P), and the port will be disconnected if a higher priority port becomes active (M).

**Example2:**

```
> CALL /MEDIA/VIDEO/XP:setDestinationPortAutoselect(O1:D)
< mO /MEDIA/VIDEO/XP:setDestinationPortAutoselect
```

**Explanation2:** The setting is changed to "DPM": Autoselect is disabled (D). The other settings remain unchanged. Since the outputs are linked, the change will affect local and link out.

### 7.6.7. Query the Input Port Priority

**Command format:** GET●/MEDIA/VIDEO/XP.PortPriorityList

**Response format:** pr●/MEDIA/VIDEO/XP.PortPriorityList=<O<sub>n</sub>\_list>

The response shows the priority of each output one after another. The priority number can be from 0 to 31; 0 is the highest- and 30 is the lowest priority. 31 means that the port will be skipped from the priority list.

**Legend:**

<O<sub>n</sub>\_list>      The input port priority order of the given output port: <l<sub>1</sub>>,<l<sub>2</sub>>,...,<l<sub>m</sub>>

**Example:**

```
> GET /MEDIA/VIDEO/XP.PortPriorityList
< pr /MEDIA/VIDEO/XP.PortPriorityList=0,1,2,3
```

**Explanation:**

Priority	0	1	...	x
Video input port	l1	l2	...	l <sub>m</sub>

Highest priority is assigned to l1 port.

**ATTENTION!** The same priority number can be set to different input ports. When the priority numbers match, the input port with the lowest port number will have the highest priority.

### 7.6.8. Change the Input Port Priority

**Command format:** CALL●/MEDIA/VIDEO/XP:setAutoselectionPriority(<l<sub>n</sub>>(<O<sub>m</sub>>):<prio>)

**Response format:** mO●/MEDIA/VIDEO/XP:setAutoselectionPriority

**Legend:**

<prio>:      Priority number from 0 to 31, equal numbers are allowed (31 means that the port will be skipped from the priority list).

An input port priority can be set on an output port. Many settings can be executed by separating a semicolon (no space), see the example below.

**Example:**

```
> CALL /MEDIA/VIDEO/XP:setAutoselectionPriority(I1\ (01\):3;I2\ (01\):3)
< mO /MEDIA/VIDEO/XP:setAutoselectionPriority
```

**Explanation:**

The priority number of input 1 and Input 2 has been set to 3 on output 1. The example shows that certain control characters have been escaped: the backslash “\” character is inserted before the “(” and “)” characters. See more information about the escaping in the [Escaping](#) section.

### 7.6.9. Mute an Input Port

**Command format:** CALL●/MEDIA/VIDEO/XP:muteSource(<l<sub>n</sub>>)

**Response format:** mO●/MEDIA/VIDEO/XP:muteSource

**Example:**

```
> CALL /MEDIA/VIDEO/XP:muteSource(I1)
< mO /MEDIA/VIDEO/XP:muteSource
```

### 7.6.10. Unmute an Input Port

**Command format:** CALL●/MEDIA/VIDEO/XP:unmuteSource(<l<sub>n</sub>>)

**Response format:** mO●/MEDIA/VIDEO/XP:unmuteSource

**Example:**

```
> CALL /MEDIA/VIDEO/XP:unmuteSource(I1)
< mO /MEDIA/VIDEO/XP:unmuteSource
```

### 7.6.11. Lock an Input Port

**Command format:** CALL●/MEDIA/VIDEO/XP:lockSource(<l<sub>n</sub>>)

**Response format:** mO●/MEDIA/VIDEO/XP:lockSource

**Example:**

```
> CALL /MEDIA/VIDEO/XP:lockSource(I1)
< mO /MEDIA/VIDEO/XP:lockSource
```

### 7.6.12. Unlock an Input Port

**Command format:** CALL●/MEDIA/VIDEO/XP:unlockSource(<l<sub>n</sub>>)

**Response format:** mO●/MEDIA/VIDEO/XP:unlockSource

**Example:**

```
> CALL /MEDIA/VIDEO/XP:unlockSource(I1)
< mO /MEDIA/VIDEO/XP:unlockSource
```

### 7.6.13. Mute Output

**Command format:** CALL●/MEDIA/VIDEO/XP:muteDestination(<O<sub>n</sub>>)

**Response format:** mO●/MEDIA/VIDEO/XP:muteDestination

**Example:**

```
> CALL /MEDIA/VIDEO/XP:muteDestination(01)
< mO /MEDIA/VIDEO/XP:muteDestination
```

#### 7.6.14. Unmute Output

**Command format:** CALL●/MEDIA/VIDEO/XP:unmuteDestination(<O<sub>n</sub>>)

**Response format:** mO●/MEDIA/VIDEO/XP:unmuteDestination

**Example:**

```
> CALL /MEDIA/VIDEO/XP:unmuteDestination(01)
< m0 /MEDIA/VIDEO/XP:unmuteDestination
```

#### 7.6.15. Lock Output

**Command format:** CALL●/MEDIA/VIDEO/XP:lockDestination(<O<sub>n</sub>>)

**Response format:** mO●/MEDIA/VIDEO/XP:lockDestination

**Example:**

```
> CALL /MEDIA/VIDEO/XP:lockDestination(01)
< m0 /MEDIA/VIDEO/XP:lockDestination
```

#### 7.6.16. Unlock Output

**Command format:** CALL●/MEDIA/VIDEO/XP:unlockDestination(<O<sub>n</sub>>)

**Response format:** mO●/MEDIA/VIDEO/XP:unlockDestination

**Example:**

```
> CALL /MEDIA/VIDEO/XP:unlockDestination(01)
< m0 /MEDIA/VIDEO/XP:unlockDestination
```

#### 7.6.17. HDCP Setting (Input Port)

HDCP capability can be enabled/disabled on the input ports, thus, non-encrypted content can be seen on a non-HDCP compliant display. See more information in the [HDCP Management](#) section.

**Command format:** SET●/MEDIA/VIDEO/<I<sub>n</sub>>.HdcpEnable=true|false

**Response format:** pw●/MEDIA/VIDEO/<I<sub>n</sub>>.HdcpEnable=true|false

**Example:**

```
> SET /MEDIA/VIDEO/I2.HdcpEnable=true
< pw /MEDIA/VIDEO/I2.HdcpEnable=true
```

#### 7.6.18. HDCP Setting (Output Port)

HDCP capability can be set to Auto/Always on the output ports, thus, non-encrypted content can be transmitted to a non-HDCP compliant display. See more information in the [HDCP Management](#) section.

**Command format:** SET●/MEDIA/VIDEO/<O<sub>n</sub>>.HdcpModeSetting=0|1

**Response format:** pw●/MEDIA/VIDEO/<O<sub>n</sub>>.HdcpModeSetting=0|1

**Parameters:**

.HdcpModeSetting	0	1
HDCP mode	Auto	Always

**Example:**

```
> SET /MEDIA/VIDEO/01.HdcpModeSetting=0
< pw /MEDIA/VIDEO/01.HdcpModeSetting=0
```

#### 7.6.19. Test Pattern Generator

The output ports can send a special image towards the sink devices for testing purposes. The setting is available on output ports with the below-listed parameters.

**ATTENTION!** The Mode can be set individually on each port, but the Clock source and the Pattern settings are common on the TPS and HDMI output ports (O1 and O2).

**Test Pattern Generator Mode Setting:**

**Command format:** SET●/MEDIA/VIDEO/<O<sub>n</sub>>.TpgMode=0|1|2

**Response format:** pw●/MEDIA/VIDEO/<O<sub>n</sub>>.TpgMode=0|1|2

**Parameters:**

.TpgMode	0	1	2
Test pattern generator mode	<b>Disabled</b> The test pattern is not displayed on the output	<b>Enabled</b> The test pattern is displayed on the output	<b>No signal mode</b> The test pattern is displayed if there is no signal on the output port

**Example:**

```
> SET /MEDIA/VIDEO/01.TpgMode=2
< pw /MEDIA/VIDEO/01.TpgMode=2
```

**Clock Source – The Clock Frequency of the Test Pattern**

**Command format:** SET●/MEDIA/VIDEO/<O<sub>n</sub>>.TpgClockSource=480|576|EXT

**Response format:** pw●/MEDIA/VIDEO/<O<sub>n</sub>>.TpgClockSource=480|576|EXT

**Parameters:**

.TpgClockSource	480	576	EXT
Clock frequency	480p	576p	External clock (from actual TMDS source)

**Example:**

```
> SET /MEDIA/VIDEO/01.TpgClockSource=576
< pw /MEDIA/VIDEO/01.TpgClockSource=576
```

**Test Pattern**

**Command format:** SET●/MEDIA/VIDEO/<O<sub>n</sub>>.TpgPattern=<pattern>

**Response format:** pw●/MEDIA/VIDEO/<O<sub>n</sub>>.TpgPattern=<pattern>

**Parameters:**

<pattern>	RED	GREEN	BLUE	BLACK	WHITE	RAMP	CHESS	BAR	CYCLE
-----------	-----	-------	------	-------	-------	------	-------	-----	-------

Cycle setting means all the patterns are changed sequentially approx. in every 2 seconds.

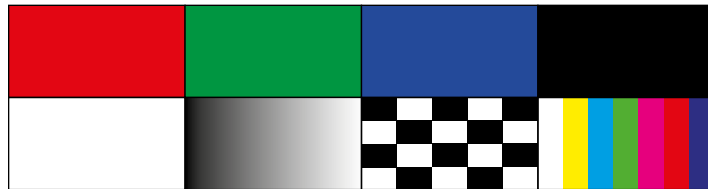

**Example:**

```
> SET /MEDIA/VIDEO/01.TpgPattern=GREEN
< pw /MEDIA/VIDEO/01.TpgPattern=GREEN
```

**7.6.20. HDMI Mode Settings (Output Port)**

**Command format:** SET●/MEDIA/VIDEO/<O<sub>n</sub>>.HdmiModeSetting=0|1|2

**Response format:** pw●/MEDIA/VIDEO/<O<sub>n</sub>>.HdmiModeSetting=0|1|2

**Parameters:**

.HdmiModeSetting	0	1	2
HDMI mode	Auto	DVI	HDMI

**Example:**

```
> SET /MEDIA/VIDEO/01.HdmiModeSetting=2
< pw /MEDIA/VIDEO/01.HdmiModeSetting=2
```

**7.6.21. Query the Recent TPS Mode**

**Command format:** GET●/REMOTE/D<sub>n</sub>.tpsMode

**Response format:** pr●/REMOTE/D<sub>n</sub>.tpsMode=A|H|L|1|2

**Parameters:**

.tpsMode	A	H	L	1	2
TPS mode	Auto	HDBaseT	Long reach	LPPF1	LPPF2

**Example:**

```
> GET /REMOTE/D1.tpsMode
< pr /REMOTE/D1.tpsMode=H
```

See more information about TPS modes in the [TPS Interface](#) section.

**7.6.22. TPS Mode Settings**

**Command format:** SET●/REMOTE/D<sub>n</sub>.tpsModeSetting=A|H|L|1|2

**Response format:** pw●/REMOTE/D<sub>n</sub>.tpsModeSetting=A|H|L|1|2

**Parameters:** See at previous section.

**Example:**

```
> SET /REMOTE/D1.tpsModeSetting=A
< pw /REMOTE/D1.tpsModeSetting=A
```

See more information about TPS modes in the [TPS Interface](#) section.

## 7.7. Audio Port Settings

INFO: Audio port numbering can be found in the [Port Numbering](#) section.

### 7.7.1. Query the Status of Source Ports

**Command format:** GET●/MEDIA/AUDIO/XP.SourcePortStatus

**Response format:** pr●/MEDIA/AUDIO/XP.SourcePortStatus=[<I<sub>1</sub>>;<I<sub>2</sub>>;...;<I<sub>n</sub>>]

The response contains 5 ASCII characters for each port. The first character indicates the mute/lock state, the next four characters represent a 2-byte HEX code showing the current state of the input ports.

**Example:**

```
> GET /MEDIA/AUDIO/XP.SourcePortStatus
< pr /MEDIA/AUDIO/XP.SourcePortStatus=T000F;M000B;T000A;T000A;T000F
```

**Legend:**

Letter (Character 1)		
	Mute state	Lock state
T	Unmuted	Unlocked
L	Unmuted	Locked
M	Muted	Unlocked
U	Muted	Locked

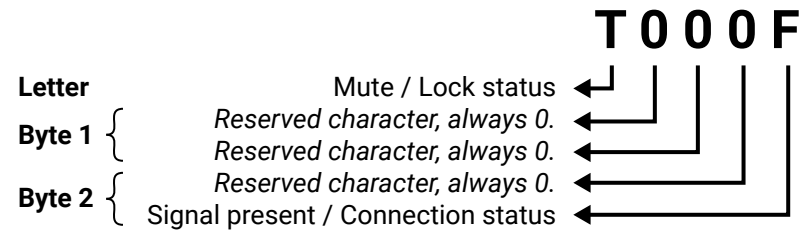

	Byte 1				Byte 2			
	Character 2		Character 3		Character 4		Character 5	
	BIT 7-6	BIT 5-4	BIT 3-2	BIT 1-0	BIT 7-6	BIT 5-4	BIT 3-2	BIT 1-0
00	Reserved	Reserved	Reserved	Reserved	Reserved	Reserved	Signal present status	Connection status
01	Reserved	Reserved	Reserved	Reserved	Reserved	Reserved	Unknown	Reserved
10	Reserved	Reserved	Reserved	Reserved	Reserved	Reserved	No signal	Not connected
11	Reserved	Reserved	Reserved	Reserved	Reserved	Reserved	Signal presents	Connected

**Example and Explanation (for input 2, M000B):**

M	0		0		0		B	
Unlocked, Unmuted	00	00	00	00	00	00	10	11
Muted	Reserved	Reserved	Reserved	Reserved	Reserved	Reserved	No signal	Connected

### The Most Common Received Port Status Responses

T000A	T	0		0		0		A	
	Unlocked, Unmuted	00	00	00	00	00	00	00	10
	Reserved	Reserved	Reserved	Reserved	Reserved	Reserved	Reserved	No signal	Not connected

T000B	T	0		0		0		B	
	Unlocked, Unmuted	00	00	00	00	00	00	00	10
	Reserved	Reserved	Reserved	Reserved	Reserved	Reserved	Reserved	No signal	Connected

T000F	T	0		0		0		F	
	Unlocked, Unmuted	00	00	00	00	00	00	00	11
	Reserved	Reserved	Reserved	Reserved	Reserved	Reserved	Reserved	Signal presents	Connected

### 7.7.2. Query the Status of Destination Port

**Command format:** GET●/MEDIA/AUDIO/XP.DestinationPortStatus

**Response format:** pr●/MEDIA/AUDIO/XP.DestinationPortStatus=[<O<sub>n</sub>>]

The response contains 5 ASCII characters for each port. The first character indicates the mute/lock state, the next 2-byte long HEX code showing the current state of the output ports.

**Example:**

```
> GET /MEDIA/AUDIO/XP.DestinationPortStatus
< pr /MEDIA/AUDIO/XP.DestinationPortStatus=T000F;T000A
```

**Legend:** See at previous section.

**Example and Explanation (for output 1, T000F):**

T	0		0		0		F	
Unlocked, Unmuted	00	00	00	00	00	00	11	11
Muted	Reserved	Reserved	Reserved	Reserved	Reserved	Reserved	Signal presents	Connected



### 7.7.3. Query the Audio Crosspoint Setting

**Command format:** GET●/MEDIA/AUDIO/XP.DestinationConnectionList

**Response format:** pr●/MEDIA/AUDIO/XP.DestinationConnectionList=<I<sub>n</sub>>

**Legend:**

<I<sub>n</sub>>: Audio input port number

**Example:**

```
> GET /MEDIA/AUDIO/XP.DestinationConnectionList
< pr /MEDIA/AUDIO/XP.DestinationConnectionList=I1
```

**Explanation:** I1 input port is connected to the output port.

### 7.7.4. Switching Audio Input

**Command format:** CALL●/MEDIA/AUDIO/XP:switch(<I<sub>n</sub>>:<O<sub>m</sub>>)

**Response format:** mO●/MEDIA/AUDIO/XP:switch

**Example:**

```
> CALL /MEDIA/AUDIO/XP:switch(I2:O1)
< mO /MEDIA/AUDIO/XP:switch
```

**Explanation:** I2 port is connected to O1 port.

### 7.7.5. Query the Audio Autoselect Settings

**Command format:** GET●/MEDIA/AUDIO/XP.DestinationPortAutoselect

**Response format:** pr●/MEDIA/AUDIO/XP.DestinationPortAutoselect=<O<sub>n</sub>\_set>

The response shows the settings of each output one by one.

**Legend:**

<O<sub>n</sub>\_set> Two-letter code of the Autoselect settings:

Letter	Explanation	
1 <sup>st</sup> letter	E:	Autoselect is <b>enabled</b> .
	D:	Autoselect is <b>disabled</b> .
2 <sup>nd</sup> letter	F:	<b>First</b> detect mode: the first active audio input is selected.
	P:	<b>Priority</b> detect mode: always the highest priority active audio input will be selected.
	L:	<b>Last</b> detect mode: always the last attached input is switched to the output automatically.

**Example:**

```
> GET /MEDIA/AUDIO/XP.DestinationPortAutoselect
< pr /MEDIA/AUDIO/XP.DestinationPortAutoselect=EL
```

**Explanation:**

**EL:** the Autoselect is Enabled on output, selected mode is Last detect.

INFO: For more information about the Autoselect feature see [The Autoselect Feature](#) section.

### 7.7.6. Change the Autoselect Mode

**Command format:** CALL●/MEDIA/AUDIO/XP:setDestinationPortAutoselect(<O<sub>n</sub>>:<O<sub>n</sub>\_set>)

**Response format:** mO●/MEDIA/AUDIO/XP:setDestinationPortAutoselect

**Legend:** See at previous section.

**Example1:**

```
> CALL /MEDIA/AUDIO/XP:setDestinationPortAutoselect(O1:EPM)
< mO /MEDIA/AUDIO/XP:setDestinationPortAutoselect
```

**Explanation1:** The setting is changed to "EPM": Autoselect is enabled (E); the mode is set to "priority detect" (P), and the port will be disconnected if a higher priority port becomes active (M).

**Example2:**

```
> CALL /MEDIA/AUDIO/XP:setDestinationPortAutoselect(O1:D)
< mO /MEDIA/AUDIO/XP:setDestinationPortAutoselect
```

**Explanation2:** The setting is changed to "DPM": Autoselect is disabled (D). The other settings remain unchanged. Since the outputs are linked, the change will affect local and link out.

INFO: For more information about the Autoselect feature see [The Autoselect Feature](#) section.

### 7.7.7. Query the Input Port Priority

**Command format:** GET●/MEDIA/AUDIO/XP.PortPriorityList

**Response format:** pr●/MEDIA/AUDIO/XP.PortPriorityList=<O<sub>n</sub>\_list>

The response shows the priority of each output one after another. The priority number can be from 0 to 31; 0 is the highest- and 30 is the lowest priority. 31 means that the port will be skipped from the priority list.

**Legend:**

<O<sub>n</sub>\_list>      The input port priority order of the given output port: <I<sub>1</sub>>,<I<sub>2</sub>>,...,<I<sub>m</sub>>

**Example:**

```
> GET /MEDIA/AUDIO/XP.PortPriorityList
< pr /MEDIA/AUDIO/XP.PortPriorityList=0,1,2,3,4
```

**Explanation:**

Priority	0	1	...	x
Video input port	I1	I2	...	I <sub>m</sub>

Highest priority is assigned to I1 port.

**ATTENTION!** The same priority number can be set to different input ports. When the priority numbers match, the input port with the lowest port number will have the highest priority.

### 7.7.8. Change the Input Port Priority

**Command format:** CALL●/MEDIA/AUDIO/XP:setAutoselectionPriority(<I<sub>n</sub>>(<O<sub>m</sub>>):<prio>)

**Response format:** mO●/MEDIA/AUDIO/XP:setAutoselectionPriority

**Legend:**

<prio>:      Priority number from 0 to 31, equal numbers are allowed (31 means that the port will be skipped from the priority list).

An input port priority can be set on an output port. Many settings can be executed by separating a semicolon (no space), see the example below.

**Example:**

```
> CALL /MEDIA/VIDEO/XP:setAutoselectionPriority(I1\ (01\):4;I2\ (01\):4)
< mO /MEDIA/VIDEO/XP:setAutoselectionPriority
```

**Explanation:**

The priority number of input 1 and Input 2 has been set to 4 on output 1. The example shows that certain control characters have been escaped: the backslash “\” character is inserted before the “(” and “)” characters. See more information about the escaping in the [Escaping](#) section.

### 7.7.9. Mute an Audio Input

**Command format:** CALL●/MEDIA/AUDIO/XP:muteSource(<I<sub>n</sub>>)

**Response format:** mO●/MEDIA/AUDIO/XP:muteSource

**Example:**

```
> CALL /MEDIA/AUDIO/XP:muteSource(I1)
< mO /MEDIA/AUDIO/XP:muteSource
```

### 7.7.10. Unmute an Audio Input

**Command format:** CALL●/MEDIA/AUDIO/XP:unmuteSource(<I<sub>n</sub>>)

**Response format:** mO●/MEDIA/AUDIO/XP:unmuteSource

**Example:**

```
> CALL /MEDIA/AUDIO/XP:unmuteSource(I1)
< mO /MEDIA/AUDIO/XP:unmuteSource
```

### 7.7.11. Lock an Input Port

**Command format:** CALL●/MEDIA/AUDIO/XP:lockSource(<I<sub>n</sub>>)

**Response format:** mO●/MEDIA/AUDIO/XP:lockSource

**Example:**

```
> CALL /MEDIA/AUDIO/XP:lockSource(I1)
< mO /MEDIA/AUDIO/XP:lockSource
```

### 7.7.12. Unlock an Input Port

**Command format:** CALL●/MEDIA/AUDIO/XP:unlockSource(<I<sub>n</sub>>)

**Response format:** mO●/MEDIA/AUDIO/XP:unlockSource

**Example:**

```
> CALL /MEDIA/AUDIO/XP:unlockSource(I1)
< mO /MEDIA/AUDIO/XP:unlockSource
```

### 7.7.13. Mute Audio Output

**Command format:** CALL●/MEDIA/AUDIO/XP:muteDestination(<O<sub>n</sub>>)

**Response format:** mO●/MEDIA/AUDIO/XP:muteDestination

**Example:**

```
> CALL /MEDIA/AUDIO/XP:muteDestination(01)
< mO /MEDIA/AUDIO/XP:muteDestination
```

### 7.7.14. Unmute Audio Output

**Command format:** CALL●/MEDIA/AUDIO/XP:unmuteDestination(<O<sub>n</sub>>)

**Response format:** mO●/MEDIA/AUDIO/XP:unmuteDestination

**Example:**

```
> CALL /MEDIA/AUDIO/XP:unmuteDestination(01)
< mO /MEDIA/AUDIO/XP:unmuteDestination
```

### 7.7.15. Lock Output

**Command format:** CALL●/MEDIA/AUDIO/XP:lockDestination(<O<sub>n</sub>>)

**Response format:** mO●/MEDIA/AUDIO/XP:lockDestination

**Example:**

```
> CALL /MEDIA/AUDIO/XP:lockDestination(01)
< mO /MEDIA/AUDIO/XP:lockDestination
```

### 7.7.16. Unlock Output

**Command format:** CALL●/MEDIA/AUDIO/XP:unlockDestination(<O<sub>n</sub>>)

**Response format:** mO●/MEDIA/AUDIO/XP:unlockDestination

**Example:**

```
> CALL /MEDIA/AUDIO/XP:unlockDestination(01)
< mO /MEDIA/AUDIO/XP:unlockDestination
```

### 7.7.17. Analog Audio Input Level Settings

#### Volume

**Command format:** SET●/MEDIA/AUDIO/<I<sub>n</sub>>.Volume=<level>

**Response format:** pw●/MEDIA/AUDIO/<I<sub>n</sub>>.Volume=<level>

**Parameters:**

<level> Sets the input volume (attenuation) between -95.625 dB and 0 dB in step of -0.375 dB. The value is rounded up if necessary to match with the step value.

**Example:**

```
> SET /MEDIA/AUDIO/I1.Volume=-15
< pw /MEDIA/AUDIO/I1.Volume=-15.000
```

#### Balance

**Command format:** SET●/MEDIA/AUDIO/<I<sub>n</sub>>.Balance=<level>

**Response format:** pw●/MEDIA/AUDIO/<I<sub>n</sub>>.Balance=<level>

**Parameters:**

<level> Sets the balance; 0 means left balance, 100 means right balance, step is 1. Center is 50 (default).

**Example:**

```
> SET /MEDIA/AUDIO/I5.Balance=75
< pw /MEDIA/AUDIO/I5.Balance=75
```

**Explanation:** The balance level of the right audio sink is set to 75%, the left one is set to 25%.

#### Gain

**Command format:** SET●/MEDIA/AUDIO/<I<sub>n</sub>>.Gain=<level>

**Response format:** pw●/MEDIA/AUDIO/<I<sub>n</sub>>.Gain=<level>

**Parameters:**

<level> Sets the input gain (attenuation) between -12 dB and 6 dB in step of 3 dB. The value is rounded up if necessary to match with the step value.

**Example:**

```
> SET /MEDIA/AUDIO/I5.Gain=3
< pw /MEDIA/AUDIO/I5.Gain=3
```

## 7.8. Network Configuration

### 7.8.1. Query the DHCP State

**Command format:** GET●/MANAGEMENT/NETWORK.DhcpEnabled

**Response format:** pw●/MANAGEMENT/NETWORK.DhcpEnabled=true|false

**Example:**

```
> GET /MANAGEMENT/NETWORK.DhcpEnabled
< pw /MANAGEMENT/NETWORK.DhcpEnabled=true
```

### 7.8.2. Change the DHCP State

**Command format:** SET●/MANAGEMENT/NETWORK.DhcpEnabled=true|false

**Response format:** pw●/MANAGEMENT/NETWORK.DhcpEnabled=true|false

**Example:**

```
> SET /MANAGEMENT/NETWORK.DhcpEnabled=false
< pw /MANAGEMENT/NETWORK.DhcpEnabled=false
```

### 7.8.3. Query the IP Address

**Command format:** GET●/MANAGEMENT/NETWORK.IpAddress

**Response format:** pr●/MANAGEMENT/NETWORK.IpAddress=<IP\_Address>

**Example:**

```
> GET /MANAGEMENT/NETWORK.IpAddress
< pr /MANAGEMENT/NETWORK.IpAddress=192.168.0.100
```

### 7.8.4. Change the IP Address (Static)

**Command format:** SET●/MANAGEMENT/NETWORK.StaticIpAddress=<IP\_address>

**Response format:** pw●/MANAGEMENT/NETWORK.StaticIpAddress=<IP\_address>

**Example:**

```
> SET /MANAGEMENT/NETWORK.StaticIpAddress=192.168.0.85
< pw /MANAGEMENT/NETWORK.StaticIpAddress=192.168.0.85
```

### 7.8.5. Query the Subnet Mask

**Command format:** GET●/MANAGEMENT/NETWORK.NetworkMask

**Response format:** pr●/MANAGEMENT/NETWORK.NetworkMask=<netmask>

**Example:**

```
> GET /MANAGEMENT/NETWORK.NetworkMask
< pr /MANAGEMENT/NETWORK.NetworkMask=255.255.255.0
```

### 7.8.6. Change the Subnet Mask (Static)

**Command format:** SET●/MANAGEMENT/NETWORK.StaticNetworkMask=<netmask>

**Response format:** pw●/MANAGEMENT/NETWORK.StaticNetworkMask=<netmask>

**Example:**

```
> SET /MANAGEMENT/NETWORK.StaticNetworkMask=255.255.255.0
< pw /MANAGEMENT/NETWORK.StaticNetworkMask=255.255.255.0
```

### 7.8.7. Query the Gateway Address

**Command format:** GET●/MANAGEMENT/NETWORK.GatewayAddress

**Response format:** pr●/MANAGEMENT/NETWORK.GatewayAddress=<gw\_address>

**Example:**

```
> GET /MANAGEMENT/NETWORK.GatewayAddress
< pr /MANAGEMENT/NETWORK.GatewayAddress=192.168.0.1
```

### 7.8.8. Change the Gateway Address (Static)

**Command format:** SET●/MANAGEMENT/NETWORK.StaticGatewayAddress=<gw\_address>

**Response format:** pw●/MANAGEMENT/NETWORK.StaticGatewayAddress=<gw\_address>

**Example:**

```
> SET /MANAGEMENT/NETWORK.StaticGatewayAddress=192.168.0.5
< pw /MANAGEMENT/NETWORK.StaticGatewayAddress=192.168.0.5
```

## 7.9. RS-232 Port Configuration

**ATTENTION!** The RS-232 **Operation mode** is mirrored on the Local and Link serial port. The other settings can be adjusted separately on the two ports (P1 and P2).

**INFO:** RS-232 port numbering can be found in the [Port Numbering](#) section.

### 7.9.1. Protocol Setting

**Command format:** SET●/MEDIA/UART/<P<sub>n</sub>>.ControlProtocol=0|1

**Response format:** pw●/MEDIA/UART/<P<sub>n</sub>>.ControlProtocol=0|1

**Parameters:**

.ControlProtocol	0	1
RS-232 protocol mode	LW2	LW3

**Example:**

```
> SET /MEDIA/UART/P1.ControlProtocol=1
< pw /MEDIA/UART/P1.ControlProtocol=1
```

### 7.9.2. BAUD Rate Setting

**Command format:** SET●/MEDIA/UART/<P<sub>n</sub>>.Baudrate=0|1|2|3|4|5|6|7

**Response format:** pw●/MEDIA/UART/<P<sub>n</sub>>.Baudrate=0|1|2|3|4|5|6|7

**Parameters:**

.Baudrate	0	1	2	3	4	5	6	7
BAUD rate value	4800	7200	9600	14400	19200	38400	57600	115200

**Example:**

```
> SET /MEDIA/UART/P1.Baudrate=2
< pw /MEDIA/UART/P1.Baudrate=2
```

### 7.9.3. Databit Setting

**Command format:** SET●/MEDIA/UART/<P<sub>n</sub>>.DataBits=8|9

**Response format:** pw●/MEDIA/UART/<P<sub>n</sub>>.DataBits=8|9

**Example:**

```
> SET /MEDIA/UART/P1.DataBits=8
< pw /MEDIA/UART/P1.DataBits=8
```

### 7.9.4. Stopbits Setting

**Command format:** SET●/MEDIA/UART/<P<sub>n</sub>>.StopBits=0|1|2

**Response format:** pw●/MEDIA/UART/<P<sub>n</sub>>.StopBits=0|1|2

**Parameters:**

.StopBits	0	1	2
Stopbit value	1	1,5	2

**Example:**

```
> SET /MEDIA/UART/P1.StopBits=0
< pw /MEDIA/UART/P1.StopBits=0
```

### 7.9.5. Parity Setting

**Command format:** SET●/MEDIA/UART/<P<sub>n</sub>>.Parity=0|1|2

**Response format:** pw●/MEDIA/UART/<P<sub>n</sub>>.Parity=0|1|2

**Parameters:**

.Parity	0	1	2
Parity setting	no parity	odd	even

**Example:**

```
> SET /MEDIA/UART/P1.Parity=0
< pw /MEDIA/UART/P1.Parity=0
```

### 7.9.6. RS-232 Operation Mode

**Command format:** SET●/MEDIA/UART/<P<sub>n</sub>>.Rs232Mode=0|1|2

**Response format:** pw●/MEDIA/UART/<P<sub>n</sub>>.Rs232Mode=0|1|2

**Parameters:**

.Rs232Mode	0	1	2
RS-232 operation mode	Pass-through	Control	Command injection

**Example:**

```
> SET /MEDIA/UART/P1.Rs232Mode=1
< pw /MEDIA/UART/P1.Rs232Mode=1
```

INFO: See more information about RS-232 modes in the [Serial Interface](#) section.

#### Command Injection Mode

**Command format:** SET●/MEDIA/UART/<P<sub>n</sub>>.CommandInjectionEnable=true|false

**Response format:** pw●/MEDIA/UART/<P<sub>n</sub>>.CommandInjectionEnable=true|false

**Example:**

```
> SET /MEDIA/UART/P1.CommandInjectionEnable=true
< pw /MEDIA/UART/P1.CommandInjectionEnable=true
```

**ATTENTION!** The Command injection status is stored in another read-only property: /MEDIA/UART/<P<sub>n</sub>>.CommandInjectionStatus.



## 7.10. Infrared Port Configuration

INFO: Infrared input and output port numbering can be found in the [Port Numbering](#) section.

### 7.10.1. Enable Command Injection Mode

**Command format:** SET●/MEDIA/IR/<SID<sub>n</sub>>.CommandInjectionEnable=true|false

**Response format:** pw●/MEDIA/IR/<SID<sub>n</sub>>.CommandInjectionEnable=true|false

**Example:**

```
> SET /MEDIA/IR/S1.CommandInjectionEnable=true
< pw /MEDIA/IR/S1.CommandInjectionEnable=true
```

### 7.10.2. Enable/Disable Output Signal Modulation

**Command format:** SET●/MEDIA/IR/<D<sub>n</sub>>.EnableModulation=true|false

**Response format:** pw●/MEDIA/IR/<D<sub>n</sub>>.EnableModulation=true|false

**Example:**

```
> SET /MEDIA/IR/D1.EnableModulation=false
< pw /MEDIA/IR/D1.EnableModulation=false
```

**Explanation:** Signal modulation is turned off on IR output (D1).

INFO: The default setting value is "true" (enabled).

## 7.11. Sending Message via the Communication Ports

### 7.11.1. Sending Message via TCP Port

The device can be used for sending a message to a certain IP:port address. The three different commands allow controlling the connected (third-party) devices.

#### Sending TCP Message

The command is for sending a command messages in ASCII-format with an option for escaping special characters.

**Command format:** CALL●/MEDIA/ETHERNET.tcpMessage(<IP\_address>:<port\_no>=<message>)

**Response format:** mO●/MEDIA/ETHERNET:tcpMessage

**Example:**

```
> CALL /MEDIA/ETHERNET.tcpMessage(192.168.0.20:5555=PWR0\x0d\x0a)
< mO /MEDIA/ETHERNET:tcpMessage
```

#### Escaping in the Message

When commands need to be separated by <CR><LF> characters to be recognized by the controlled device, then they need to be escaped. You can use the following format for escaping:

<command<sub>1</sub>><\x0d\x0a><command<sub>2</sub>><\x0d\x0a>...<command<sub>n</sub>><\x0d\x0a>

#### Sending Text Message

The command is for sending a text message in ASCII-format.

INFO: Escaping will not be processed using the **tcpText** command.

**Command format:** CALL●/MEDIA/ETHERNET.tcpText(<IP\_address>:<port\_no>=<message>)

**Response format:** mO●/MEDIA/ETHERNET:tcpText

**Example:**

```
> CALL /MEDIA/ETHERNET.tcpText(192.168.0.20:5555=pwr_on)
< mO /MEDIA/ETHERNET:tcpText
```

#### Sending Binary Message

The command is for sending a binary message in HEX format.

INFO: Escaping will not be processed using the **tcpBinary** command.

**Command format:** CALL●/MEDIA/ETHERNET.tcpBinary(<IP\_address>:<port\_no>=<message>)

**Response format:** mO●/MEDIA/ETHERNET:tcpBinary

**Example:**

```
> CALL /MEDIA/ETHERNET.tcpBinary(192.168.0.20:5555=0100000061620000cdcc2c40)
< mO /MEDIA/ETHERNET:tcpBinary
```

### 7.11.2. Sending Message via UDP Port

The device can be used for sending a message to a certain IP:port address. The three different commands allow controlling the connected (third-party) devices.

#### Sending UDP Message

The command is for sending a command messages in ASCII-format with an option for escaping special characters.

**Command format:** CALL●/MEDIA/ETHERNET.udpMessage(<IP\_address>:<port\_no>=<message>)

**Response format:** mO●/MEDIA/ETHERNET:udpMessage

**Example:**

```
> CALL /MEDIA/ETHERNET.udpMessage(192.168.0.20:5555=PWR0\x0d\x0a)
< mO /MEDIA/ETHERNET:udpMessage
```

#### Escaping in the Message

When commands need to be separated by <CR><LF> characters to be recognized by the controlled device, then they need to be escaped. You can use the following format for escaping:

<command<sub>1</sub>><\x0d\x0a><command<sub>2</sub>><\x0d\x0a>...<command<sub>n</sub>><\x0d\x0a>

### Sending Text Message

The command is for sending a text message in ASCII-format.

INFO: Escaping will not be processed using the `udpText` command.

**Command format:** CALL●/MEDIA/ETHERNET.udpText(<IP\_address>:<port\_no>=<message>)

**Response format:** mO●/MEDIA/ETHERNET:udpText

**Example:**

```
> CALL /MEDIA/ETHERNET.udpText(192.168.0.20:5555=pwr_on)
< mO /MEDIA/ETHERNET:udpText
```

### Sending Binary Message

The command is for sending a binary message in HEX format.

INFO: Escaping will not be processed using the `udpBinary` command.

**Command format:** CALL●/MEDIA/ETHERNET.udpBinary(<IP\_address>:<port\_no>=<message>)

**Response format:** mO●/MEDIA/ETHERNET:udpBinary

**Example:**

```
> CALL /MEDIA/ETHERNET.udpBinary(192.168.0.20:5555=0100000061620000cdcc2c40)
< mO /MEDIA/ETHERNET:udpBinary
```

#### 7.11.3. Sending Message via an RS-232 Port

The RS-232 ports can be used for sending a command message to a device which can be controlled over serial port. Both local RS-232 and extended link RS-232 ports can be used. The three different commands allow to use different message formats.

### Sending Message

The command is for sending a command messages in ASCII-format with an option for escaping special characters.

**Command format:** CALL●/MEDIA/UART/<P<sub>n</sub>>.sendMessage(<message>)

**Response format:** mO●/MEDIA/UART/<P<sub>n</sub>>:sendMessage

**Example:**

```
> CALL /MEDIA/UART/P1.sendMessage(PWR0\x0d\x0a)
< mO /MEDIA/UART/P1:sendMessage
```

### Escaping in the Message

When commands need to be separated by <CR><LF> characters to be recognized by the controlled device, then they need to be escaped. You can use the following format for escaping:

<command<sub>1</sub>><\x0d\x0a><command<sub>2</sub>><\x0d\x0a>...<command<sub>n</sub>><\x0d\x0a>

### Sending Text Message

The command is for sending a text message in ASCII-format.

INFO: Escaping will not be processed using the `sendText` command.

**Command format:** CALL●/MEDIA/UART/<P<sub>n</sub>>.sendText(<message>)

**Response format:** mO●/MEDIA/UART/<P<sub>n</sub>>:sendText

**Example:**

```
> CALL /MEDIA/UART/P1.sendText(pwr_on)
< mO /MEDIA/UART/P1:sendText
```

### Sending Binary Message

The command is for sending a binary message in HEX format.

INFO: Escaping will not be processed using the `sendBinaryMessage` command.

**Command format:** CALL●/MEDIA/UART/<P<sub>n</sub>>.sendBinaryMessage(<message>)

**Response format:** mO●/MEDIA/UART/<P<sub>n</sub>>:sendBinaryMessage

**Example:**

```
> CALL /MEDIA/UART/P1.sendBinaryMessage(0100000061620000cdcc2c40)
< mO /MEDIA/UART/P1:sendBinaryMessage
```

## 7.12. GPIO Port Configuration

INFO: Use the GET command to query a parameter.

### 7.12.1. Set the Direction of a GPIO Pin

**Command format:** SET●/MEDIA/GPIO/P<sub>n</sub>.Direction=<dir>

**Response format:** pw●/MEDIA/GPIO/P<sub>n</sub>.Direction=<dir>

**Legend:** <dir>: direction of the GPIO pin: I=input; O=output

**Example:**

```
> SET /MEDIA/GPIO/P1.Direction=I
< pw /MEDIA/GPIO/P1.Direction=I
```

### 7.12.2. Set the Output Level of a GPIO Pin

**Command format:** SET●/MEDIA/GPIO/P<sub>n</sub>.Output=<value>

**Response format:** pw●/MEDIA/GPIO/ P<sub>n</sub>.Output=<value>

**Legend:** <value>: value of the GPIO pin: H=high level; L=low level

**Example:**

```
> SET /MEDIA/GPIO/P1.Output
< pw /MEDIA/GPIO/P1.Output=H
```

### 7.12.3. Toggle the Level of a GPIO Pin

**Command format:** CALL●/MEDIA/GPIO/P<sub>n</sub>:toggle()

**Response format:** pw●/MEDIA/GPIO/ P<sub>n</sub>:toggle

```
> CALL●/MEDIA/GPIO/P1:toggle()
< m0 /MEDIA/GPIO/P1:toggle
```

**Explanation:** If the direction of the pin is input: the output value is toggled.

If the direction of the pin is output: the output value and the input value are toggled.

## 7.13. EDID Management

### 7.13.1. Query the Emulated EDIDs

**Command format:** GET●/EDID.EdidStatus

**Response format:** pr●/EDID.EdidStatus=<E<sub>loc</sub>>:<E<sub>1</sub>>;<E<sub>loc</sub>>:<E<sub>2</sub>>;...;<E<sub>loc</sub>>:<E<sub>n</sub>>

**Example:**

```
> GET /EDID.EdidStatus
< pr /EDID.EdidStatus=D1:E1;D1:E2;D1:E3;D1:E4
```

**Explanation:** Emulated EDID memory for input port is listed with the EDID number that is currently emulated on the input.

### 7.13.2. Query the Validity of a Dynamic EDID

**Command format:** GET●/EDID/D/D<sub>n</sub>.Validity

**Response format:** pr●/EDID/D/D<sub>n</sub>.Validity=true|false

**Example:**

```
> GET /EDID/D/D1.Validity
< pr /EDID/D/D1.Validity=true
```

**Explanation:** The 'Validity' property is true, valid EDID is stored in D1 memory place.

### 7.13.3. Query the Preferred Resolution of an User EDID

**Command format:** GET●/EDID/U/U<sub>n</sub>.PreferredResolution

**Response format:** pr●/EDID/U/U<sub>n</sub>.PreferredResolution=<preferred\_resolution>

**Example:**

```
> GET /EDID/U/U2.PreferredResolution
< pr /EDID/U/U2.PreferredResolution=1920x1080p60.00Hz
```

INFO: Use the "Manufacturer" property to query the manufacturer and the "MonitorName" property to query the name of the monitor.

### 7.13.4. Emulating an EDID to an Input Port

**Command format:** CALL●/EDID:switch(<source>:<destination>)

**Response format:** mO●/EDID:switch

**Example:**

```
> CALL /EDID:switch(F49:E2)
< m0 /EDID:switch
```

**Legend:** <source>: Source EDID memory place: Factory / User / Dynamic.

<destination>: The emulated EDID memory of the desired input port.

### 7.13.5. Emulating an EDID to All Input Ports

**Command format:** CALL●/EDID:switchAll(<source>)

**Response format:** mO●/EDID:switchAll

**Example:**

```
> CALL /EDID:switchAll(F47)
< m0 /EDID:switchAll
```

**Legend:** <source> Source EDID memory place: Factory / User / Dynamic.

### 7.13.6. Copy an EDID to User Memory

**Command format:** CALL●/EDID:copy(<D<sub>n</sub>>|<E<sub>n</sub>>|<F<sub>n</sub>>|<U<sub>n</sub>>:<U<sub>m</sub>>)

**Response format:** mO●/EDID:copy

**Example:**

```
> CALL /EDID:copy(D1:U1)
< m0 /EDID:copy
```

**Explanation:** The EDID of the last connected sink of D1 (Output 1) has been copied to U1.

### 7.13.7. Deleting an EDID from User Memory

**Command format:** CALL●/EDID:delete(<U<sub>n</sub>>)

**Response format:** mO●/EDID:delete

**Example:**

```
> CALL /EDID:delete(U1)
< mO /EDID:delete
```

### 7.13.8. Resetting the Emulated EDIDs

**Command format:** CALL●/EDID:reset()

**Response format:** mO●/EDID:reset

**Example:**

```
> CALL /EDID:reset()
< mO /EDID:reset
```

**Explanation:** Calling this method switches all emulated EDIDs to factory default one. See the table in the [Factory EDID List](#) section.

## 7.14. LW3 Commands - Quick Summary

### System Commands

Operation / Path	
7.5.1	Query the Product Name
	/ProductName
7.5.2	Set the Device Label
	/MANAGEMENT/UID.DeviceLabel
7.5.3	Query the Serial Number
	/SerialNumber
7.5.4	Query the Firmware Version
	/SYS/MB.FirmwareVersion
7.5.5	Resetting the Device
	/SYS:reset()
7.5.6	Restore the Factory Default Settings
	/SYS:factoryDefaults()

### Video Port Settings

Operation / Path	
7.6.1	Query the Status of Source Ports
	/MEDIA/VIDEO/XP.SourcePortStatus
7.6.2	Query the Status of Destination Port
	/MEDIA/VIDEO/XP.DestinationPortStatus
7.6.3	Query the Video Crosspoint Setting
	/MEDIA/VIDEO/XP.DestinationConnectionList
7.6.4	Switching Video Input
	/MEDIA/VIDEO/XP:switch(<input>:<output>)
7.6.5	Query the Video Autoselect Settings
	/MEDIA/VIDEO/XP.DestinationPortAutoselect
7.6.6	Change the Autoselect Mode
	/MEDIA/VIDEO/XP:setDestinationPortAutoselect(<output>:<output_set>)
7.6.7	Query the Input Port Priority
	/MEDIA/VIDEO/XP.PortPriorityList

Operation / Path	
7.6.8	Change the Input Port Priority
	/MEDIA/VIDEO/XP:setAutoselectionPriority(<input>(<output>):<prio>)
7.6.9	Mute an Input Port
	/MEDIA/VIDEO/XP:muteSource(<input>)
7.6.10	Unmute an Input Port
	/MEDIA/VIDEO/XP:unmuteSource(<input>)
7.6.11	Lock an Input Port
	/MEDIA/VIDEO/XP:lockSource(<input>)
7.6.12	Unlock an Input Port
	/MEDIA/VIDEO/XP:unlockSource(<input>)
7.6.13	Mute Output
	/MEDIA/VIDEO/XP:muteDestination(<output>)
7.6.14	Unmute Output
	/MEDIA/VIDEO/XP:unmuteDestination(<output>)
7.6.15	Lock Output
	/MEDIA/VIDEO/XP:lockDestination(<output>)
7.6.16	Unlock Output
	/MEDIA/VIDEO/XP:unlockDestination(<output>)
7.6.17	HDCP Setting (Input Port)
	/MEDIA/VIDEO/<input>.HdcpEnable
7.6.18	HDCP Setting (Output Port)
	/MEDIA/VIDEO/<output>.HdcpModeSetting
7.6.19	Test Pattern Generator
	/MEDIA/VIDEO/<output>.TpgMode TpgClockSource TpgPattern
7.6.20	HDMI Mode Settings (Output Port)
	/MEDIA/VIDEO/<output>.HdmiModeSetting
7.6.21	Query the Recent TPS Mode
	/REMOTE/S1.tpsMode
7.6.22	TPS Mode Settings
	/REMOTE/S1.tpsModeSetting=A H L 1 2



**Audio Port Settings**

Operation / Path	
7.7.1	Query the Status of Source Ports
	/MEDIA/AUDIO/XP.SourcePortStatus
7.7.2	Query the Status of Destination Port
	/MEDIA/AUDIO/XP.DestinationPortStatus
7.7.3	Query the Audio Crosspoint Setting
	/MEDIA/AUDIO/XP.DestinationConnectionList
7.7.4	Switching Audio Input
	/MEDIA/AUDIO/XP:switch(<input>:<output>)
7.7.5	Query the Audio Autoselect Settings
	/MEDIA/AUDIO/XP.DestinationPortAutoselect
7.7.6	Change the Autoselect Mode
	/MEDIA/AUDIO/XP:setDestinationPortAutoselect(<output>:<output_set>)
7.7.7	Query the Input Port Priority
	/MEDIA/AUDIO/XP.PortPriorityList
7.7.8	Change the Input Port Priority
	/MEDIA/AUDIO/XP:setAutoselectionPriority(<input>(<output>):<prio>)
7.7.9	Mute an Audio Input
	/MEDIA/AUDIO/XP:muteSource(<input>)
7.7.10	Unmute an Audio Input
	/MEDIA/AUDIO/XP:unmuteSource(<input>)
7.7.11	Lock an Input Port
	/MEDIA/AUDIO/XP:lockSource(<input>)
7.7.12	Unlock an Input Port
	/MEDIA/AUDIO/XP:unlockSource(<input>)
7.7.13	Mute Audio Output
	/MEDIA/AUDIO/XP:muteDestination(<output>)
7.7.14	Unmute Audio Output
	/MEDIA/AUDIO/XP:unmuteDestination(<output>)
7.7.15	Lock Output
	/MEDIA/AUDIO/XP:lockDestination(<output>)

Operation / Path	
7.7.16	Unlock Output
	/MEDIA/AUDIO/XP:unlockDestination(<output>)
7.7.17	Analog Audio Input Level Settings
	/MEDIA/AUDIO/<input>.Volume Balance Gain

**Network Configuration**

Operation / Path	
7.8.1	Query the DHCP State
	/MANAGEMENT/NETWORK.DhcpEnabled
7.8.2	Change the DHCP State
	/MANAGEMENT/NETWORK.DhcpEnabled
7.8.3	Query the IP Address
	/MANAGEMENT/NETWORK.IpAddress
7.8.4	Change the IP Address (Static)
	/MANAGEMENT/NETWORK.StaticIpAddress
7.8.5	Query the Subnet Mask
	MANAGEMENT/NETWORK.NetworkMask
7.8.6	Change the Subnet Mask (Static)
	/MANAGEMENT/NETWORK.StaticNetworkMask
7.8.7	Query the Gateway Address
	/MANAGEMENT/NETWORK.GatewayAddress
7.8.8	Change the Gateway Address (Static)
	/MANAGEMENT/NETWORK.StaticGatewayAddress

**RS-232 Port Configuration**

Operation / Path	
7.9.1	Protocol Setting
	/MEDIA/UART/<port_no>.ControlProtocol
7.9.2	BAUD Rate Setting
	/MEDIA/UART/<port_no>.Baudrate
7.9.3	Databit Setting
	/MEDIA/UART/<port_no>.DataBits
7.9.4	Stopbits Setting
	/MEDIA/UART/<port_no>.StopBits
7.9.5	Parity Setting
	/MEDIA/UART/<port_no>.Parity
7.9.6	RS-232 Operation Mode
	/MEDIA/UART/<port_no>.Rs232Mode

**Infrared Port Configuration**

Operation / Path	
7.10.1	Enable Command Injection Mode
	/MEDIA/IR/<port_no>.CommandInjectionEnable
7.10.2	Enable/Disable Output Signal Modulation
	/MEDIA/IR/<port_no>.EnableModulation

**Sending Message via the Communication Ports**

Operation / Path	
7.11.1	Sending Message via TCP Port
	/MEDIA/ETHERNET.tcpText tcpMessage tcpBinary
7.11.2	Sending Message via UDP Port
	/MEDIA/ETHERNET.udpText udpMessage udpBinary
7.11.3	Sending Message via an RS-232 Port
	/MEDIA/UART/<port_no>.sendText sendMessage sendBinaryMessage

**GPIO Port Configuration**

Operation / Path	
7.12.1	Set the Direction of a GPIO Pin
	/MEDIA/GPIO/<pin>.Direction
7.12.2	Set the Output Level of a GPIO Pin
	/MEDIA/GPIO/<pin>.Output
7.12.3	Toggle the Level of a GPIO Pin
	/MEDIA/GPIO/<pin>.toggle()

**EDID Management**

Operation / Path	
7.13.1	Query the Emulated EDIDs
	/EDID.EdidStatus
7.13.2	Query the Validity of a Dynamic EDID
	/EDID/D/<dynamic_edid_memory>.Validity
7.13.3	Query the Preferred Resolution of a User EDID
	/EDID/U/<user_edid_memory>.PreferredResolution
7.13.4	Emulating an EDID to an Input Port
	/EDID:switch(<source>:<destination>)
7.13.5	Emulating an EDID to All Input Ports
	/EDID:switchAll(<source>)
7.13.6	Copy an EDID to User Memory
	/EDID:copy(<source>:<destination>)
7.13.7	Deleting an EDID from User Memory
	/EDID:delete(<user_edid_memory>)
7.13.8	Resetting the Emulated EDIDs
	/EDID:reset()

# 8

## Firmware Upgrade

The transmitter can be upgraded by using Lightware Device Updater (LDU) software over LAN. The firmware pack with the necessary components (\*.lfp file) for your specific product, the LDU application, and the User's manual can be downloaded from the Support page of our website [www.lightware.com](http://www.lightware.com).

- ▶ [ABOUT THE FIRMWARE PACKAGE \(LFP FILE\)](#)
- ▶ [SHORT INSTRUCTIONS](#)
- ▶ [INSTALL AND UPGRADE](#)
- ▶ [DETAILED INSTRUCTIONS](#)
- ▶ [KEEPING THE CONFIGURATION SETTINGS](#)
- ▶ [REMOTE FIRMWARE UPGRADE OF CONNECTED LIGHTWARE DEVICES](#)

**ATTENTION!** While the firmware is being upgraded, the normal operation mode is suspended as the transmitter is switched to bootload mode. Signal processing is not performed. Do not interrupt the firmware upgrade. If any problem occurs, reboot the device and restart the process.

**ATTENTION!** The firmware upgrade process has an effect on the configuration and the settings of the device. For more details, please see the [Keeping the Configuration Settings](#) section before the upgrade.

### 8.1. About the Firmware Package (LFP file)

The firmware files are packed in one package which is called LFP file. You need only this file to do the upgrade on your device.

- The package contains all the necessary components, binary, and other files; You do not have to get further files.
- There is a descriptor file in the package that contains each firmware with version number and a list showing the compatible devices. The descriptor is displayed after loaded the LFP file in the LDU.

### 8.2. Short Instructions

**Step 1.** Get the firmware pack and the Lightware Device Updater (LDU) application.

**Step 2.** Install the LDU application.

**Step 3.** Establish the connection between the computer and the device(s).

**Step 4.** Start the LDU and follow the instructions shown on the screen.

### 8.3. Install and Upgrade

#### Installation for Windows OS

**INFO:** The application can be installed under Windows XP or above.

Run the installer. If the User Account Control drops a pop-up message click **Yes**. During the installation you will be prompted to select the type of the installation:

Normal install	Snapshot install
Available for Windows and Mac OS X	Available for Windows
The installer can update only this instance	Cannot be updated
Only one updateable instance can exist for all users	More than one different version can be installed for all users

*Comparison of install types*

**ATTENTION!** Using the Normal install as the default value is highly recommended.

#### Installation for Mac OS X

**INFO** After the installation the Windows and the Mac application has the same look and functionality. This type of the installer is equal with the Normal install in case of Windows and results an updateable version with the same attributes.

Mount the DMG file with double clicking on it and drag the LDU icon over the Applications icon to copy the program into the Applications folder. If you want to copy the LDU into another location just drag the icon over the desired folder.

#### LDU Upgrade

**Step 1.** Run the application. In the welcome screen click on the  button in the top right corner; the About window will appear. Click on the **Check now** button. The program checks the available updates on Lightware website and shows its version.

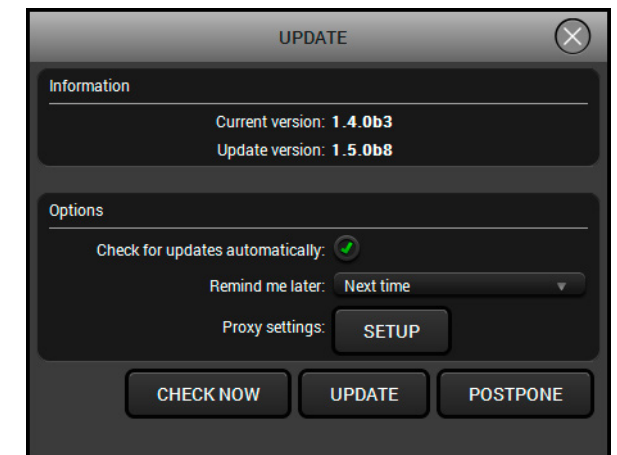

**Step 2.** Set the desired update settings in the **Options** section.

- If you do not want to check for the updates automatically, uncheck the **circle**, which contains the green tick.
- If you want to postpone the update, a reminder can be set with different delays from the **drop down list**.
- If the proxy settings traverse the update process, set the proper values then click the **OK** button.

**Step 3.** Press the **Update** button to download the new version; the installer will start.

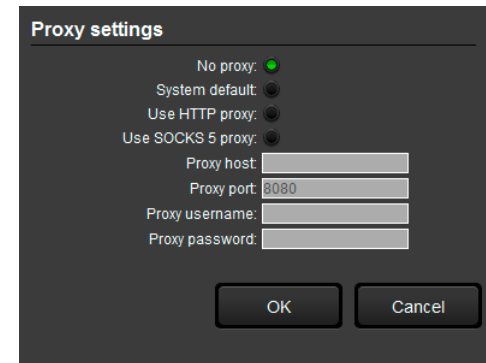

## 8.4. Detailed Instructions

### 8.4.1. Establish the Connection

Make sure that the computer and the device are connected via an Ethernet cable and the connection is established between them.

### 8.4.2. Start the LDU and Follow the Instructions

After launching LDU the welcome screen will appear:

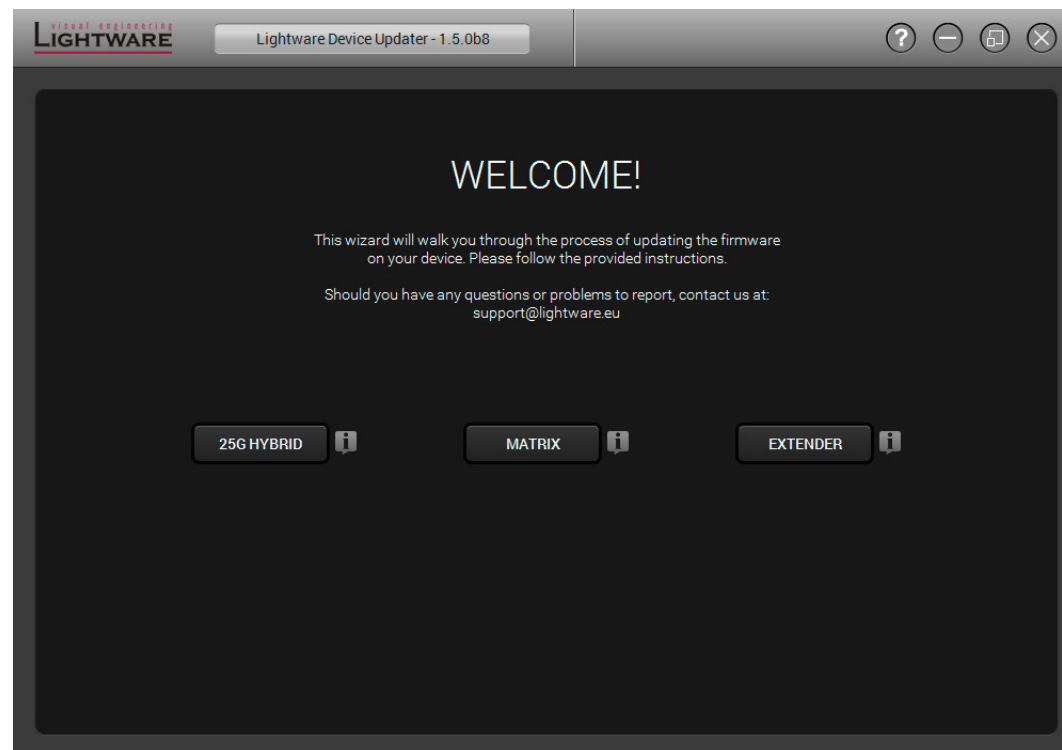

Pressing the **i** button a list will appear showing the supported devices.

Click on the **Extender** button on the main screen.

**Step 1. Select the package.**

Click on the **Browse** button and select the ".lfp" file that will be used for the upgrade.

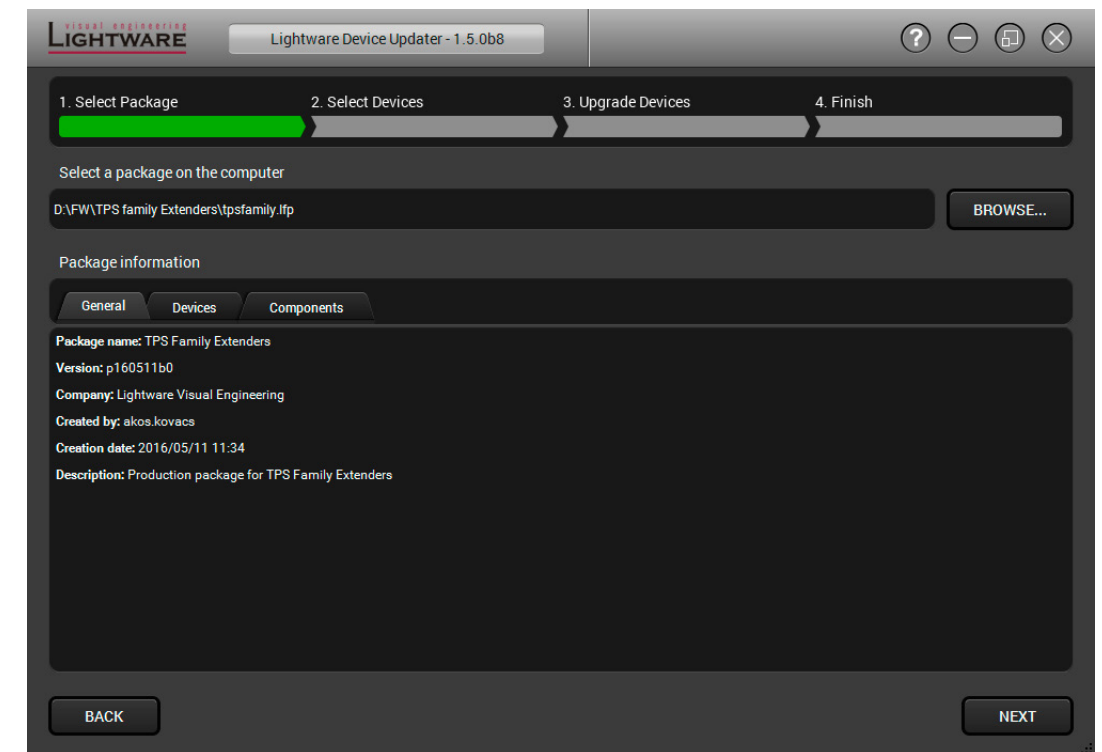

Package information is displayed:

- **General** version info, creation date, short description,
- **Devices** which are compatible with the firmware,
- **Components** in the package with release notes.

Click on the **Next** button and follow the instructions.

**TIPS AND TRICKS:** Files with ".lfp" extension are associated to LDU during installation. If you double click on the ".lfp" file, the application is launched, the package is loaded automatically and above screen is shown.

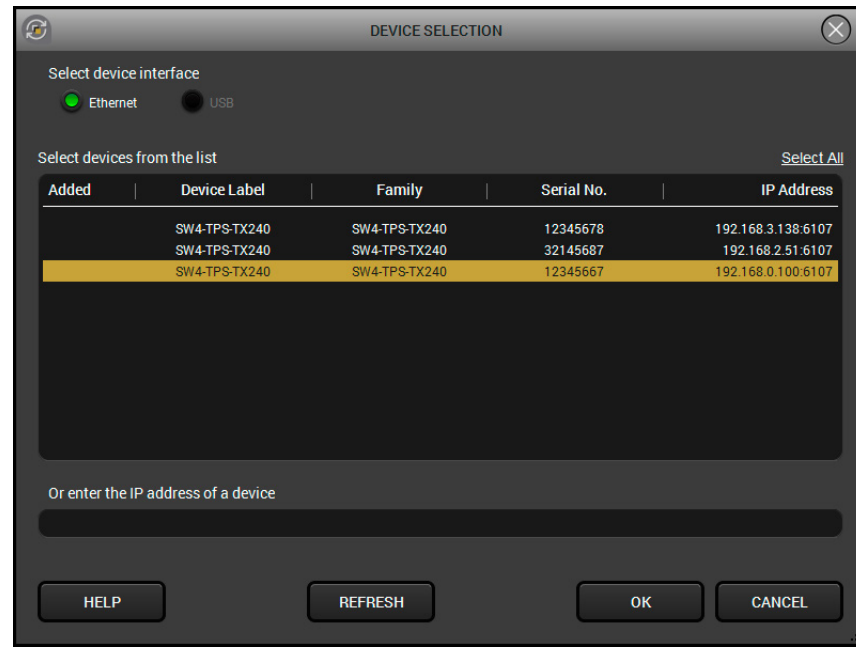
**Step 2. Select device.**

The following step is to select the desired device(s). The available and supported devices are searched and listed automatically. If the desired device is not listed, update the list by clicking the **Refresh** button. Select the desired devices: highlight them with a **yellow cursor**, then click **OK**.

A tick mark can be seen in the **Added** column if the device was added by the user previously.

**Firmware Components**

The firmware components of the selected devices are listed on the following screen: installed and update versions. (Update version will be uploaded to the device.)

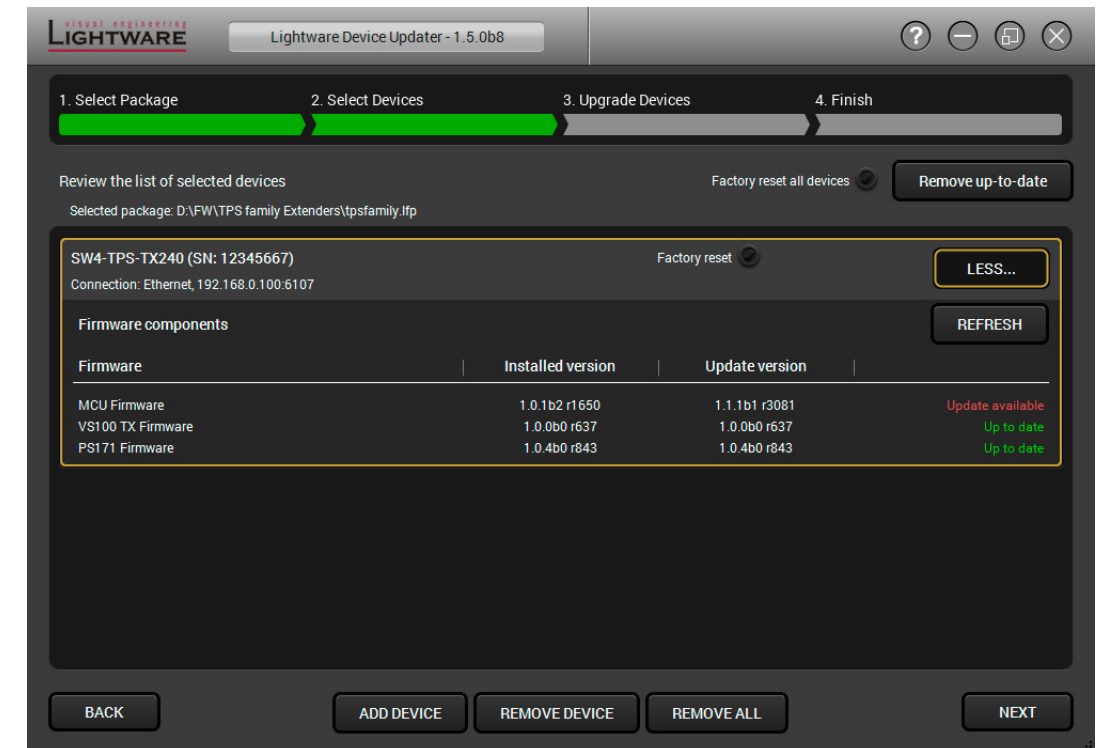

Add a device by clicking on the **Add device** button. The previous screen will be shown; select the desired device(s) and click on **OK**.

Remove a device by selecting it (highlight with yellow) and click on **Remove device** button, or click on **Remove all** button to empty the list. Devices which are not necessary to update (all firmware components are up-to-date) can be removed by the **Remove up-to-date** button from the device list.

Enabling **Factory reset** will perform factory default values for all settings in the device. Three different status can exist:

- **Enabled by user:** all settings will set to factory default values.
- **Disabled by user:** your settings will be saved and restored after upgrading.
- **Enabled by default and not changeable by user:** firmware upgrade must perform a factory reset to apply all changes coming with the new firmware version.

Click on the **Next** button to continue.



**Step 3. Upgrade the device.**

Click on the **Start** button to continue.

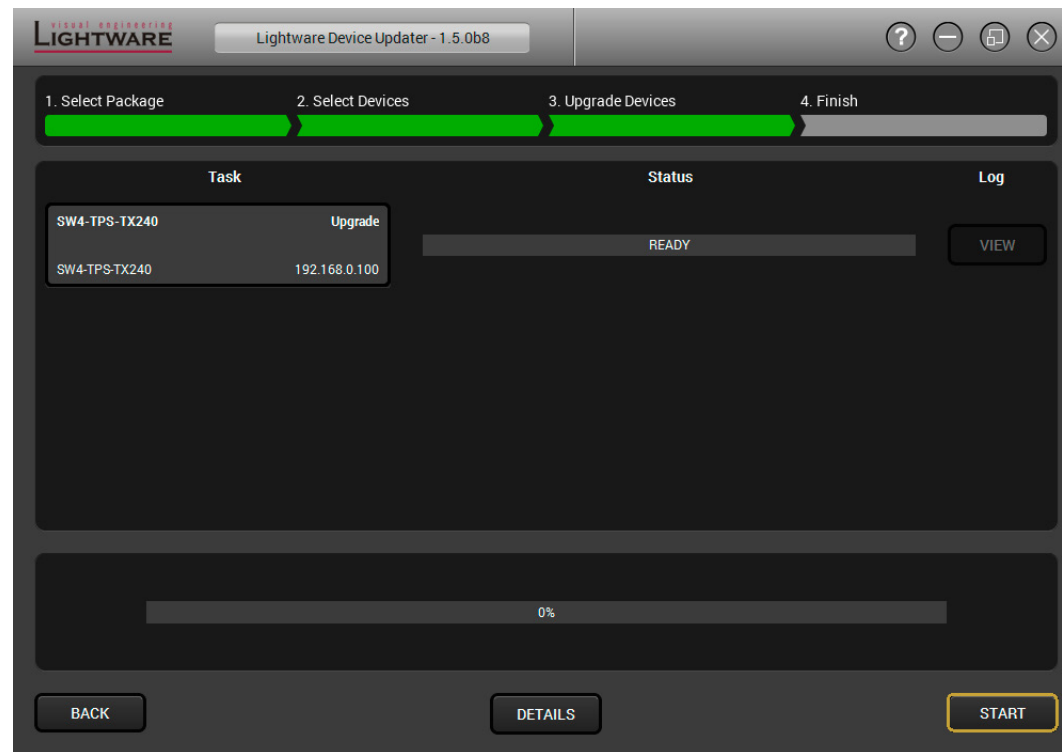

A warning window will pop up before starting upgrading the device:

- Do not unplug the power cable and the LAN cable while the upgrade is in progress. Click **OK** to continue.

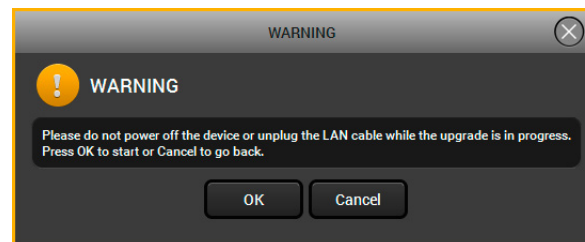

When you confirmed the warnings, the upgrade process starts automatically.

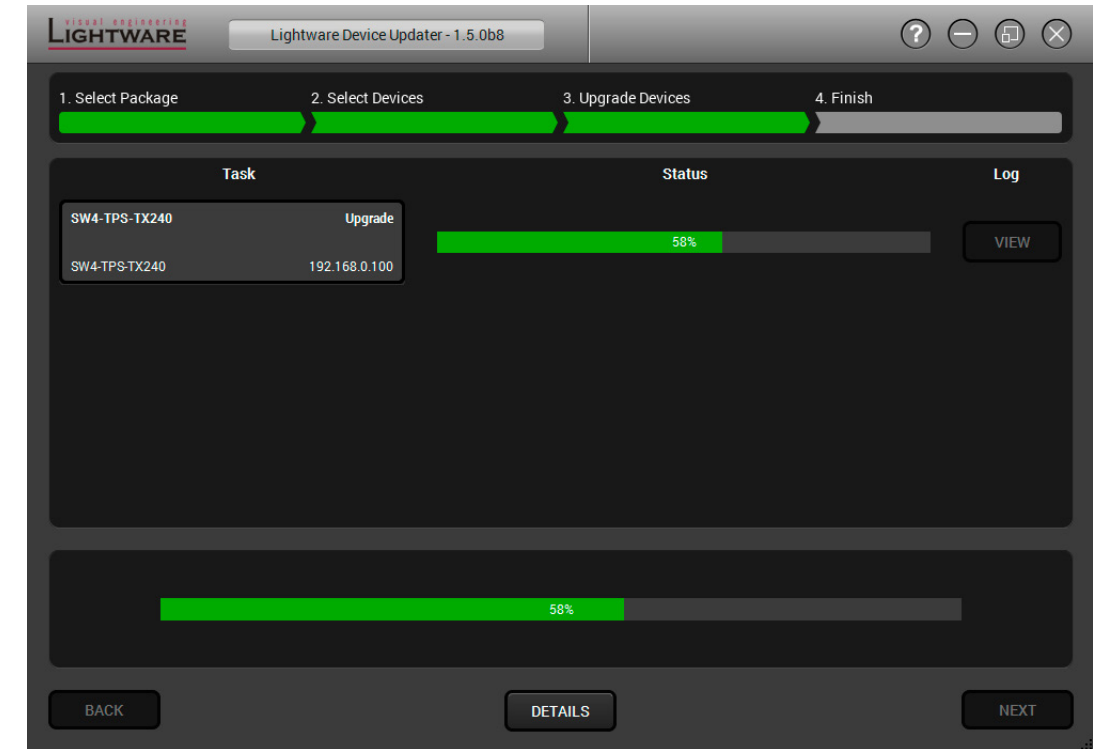

**Details** button opens a new window where the process is logged – see below.

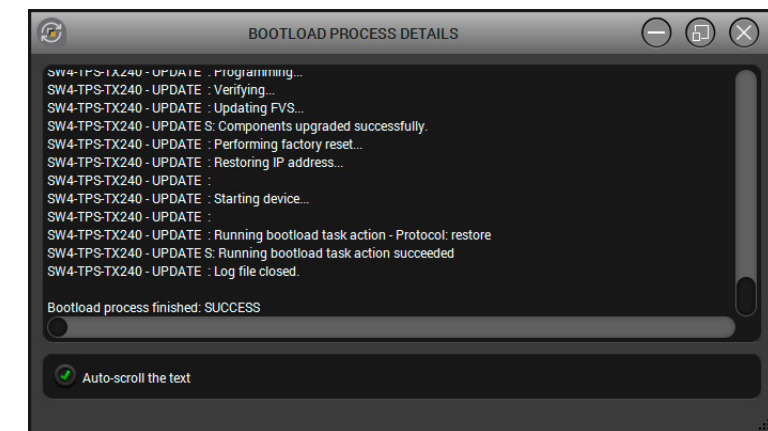

**Step 4. Finish.**

If the upgrade of a device is finished, the log can be opened by the View button on the right. When all the tasks are finished, a window appears. Click **OK** to close and **Next** to display the summary page.

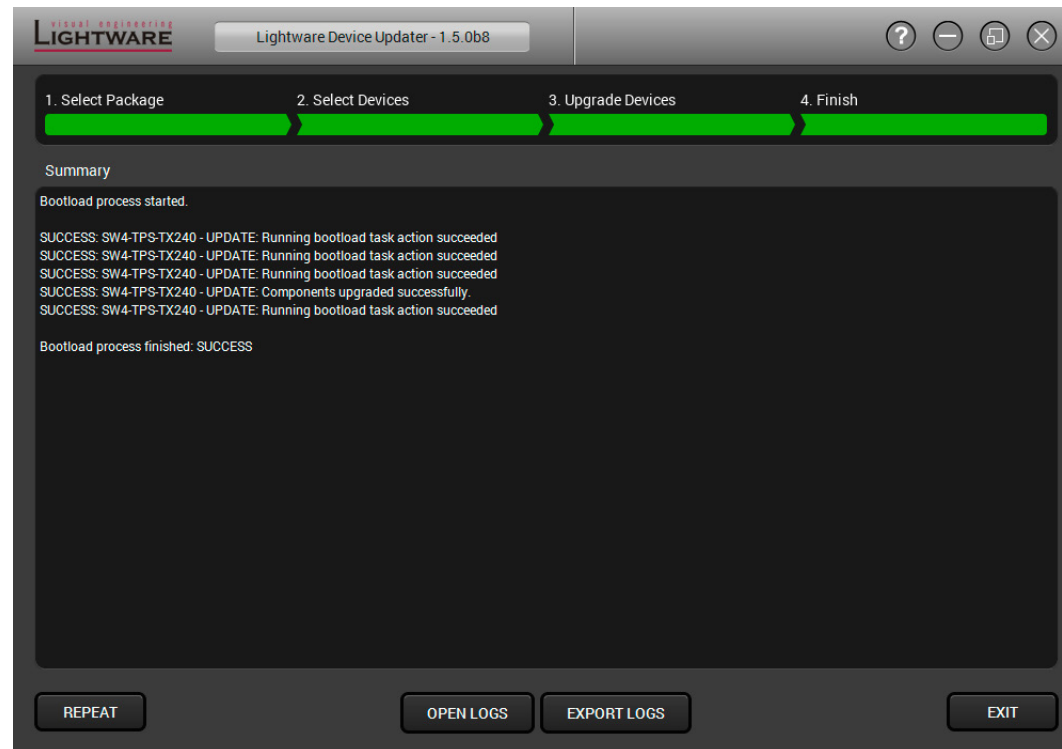

**Repeat** button starts the process again with the selected device(s).

**Open logs** button opens the temporary folder where the logs can be found.

**Export logs** by saving the files as a zipped file.

Press **Exit** to close the program.

If the upgrade failed, the progress bar of the device is changed to red; restart the device(s) and repeat the process.

**ATTENTION!** However the device is rebooted after the firmware upgrade, switching it off and on again is recommended.

**8.5. Keeping the Configuration Settings**

User can keep all configuration settings and restore to the device after firmware upgrading or can choose to perform a factory reset – it means all settings will be erased in the device. For the detailed information about saved data refer to the [Content of Backup File](#) section.

The following flow chart demonstrates how this function works in the background.



**Flow chart of firmware upgrade**

The details about the procedure: when firmware upgrade starts, the first step is making a backup of the settings of the device. The firmware package checks the backup data and if it is needed, a conversion is applied to avoid incompatibility problems between the firmware versions. If you do not want to keep configuration settings, you can set the **Factory reset** option enabled.

The instruction in the firmware package of the device will inform you about this function availability, reading it is highly recommended in every case.

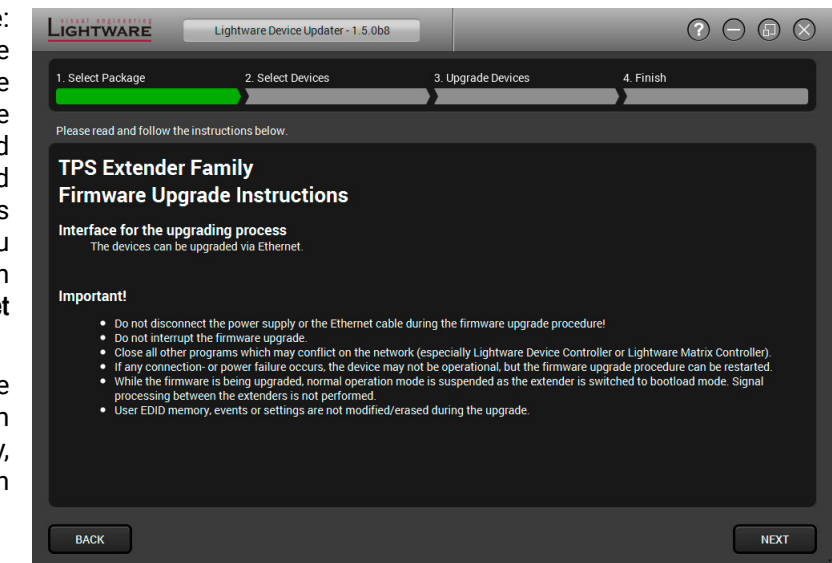

**Instructions page in the UMX-TPS-TX100 series firmware package**

**ATTENTION!** In specific cases restoring cannot be applied fully and certain settings are not copied back to the device. If a warning message appears, user can get back the original data from the backup. Logs of the upgrade procedure contain all backup data, it can be exported at the end of the upgrade procedure. In case of any question, please contact [support@lightware.com](mailto:support@lightware.com).

**ATTENTION!** In certain cases, the new firmware version requires setting all parameters to set factory defaults. In this case, the "Factory reset" option is enabled by default and not changeable by the user, see details in the [Firmware Components](#) section.

**ATTENTION!** The feature is only supported by LDU version 1.3.0 and above.

## 8.6. Remote Firmware Upgrade of Connected Lightware Devices

Firmware of Lightware devices can be upgraded via another connected Lightware device without removing the device from the system. It means user does not have to connect directly to the upgradable device, it can be reached and flashed through other devices. It's a more comfortable way to keep up-to-date your Lightware devices.



There are two types of remote upgrading:

### Extended Upgrade

- Intelligent devices can be upgraded via another intelligent or basic device via TPS or OPTS/OPTM link.
- For example, HDMI-TPS-TX200 series extenders can be upgraded via MMX6x2-HT series matrix or a HDMI-TPS-RX95 extender.

### Hosted Upgrade

- Basic devices can be upgraded only via an intelligent device via TPS link.
- For example, TPS 95 series extenders can be upgraded via MMX6x2-HT series matrix or HDMI-TPS-TX200 series extenders.
- In case of hosted upgrade, the procedure is almost the same as described in Firmware upgrade – [Detailed Instructions](#). The only difference is that the host device's name, and IP address appears beside the name of the device to be upgraded.

**ATTENTION!** During hosted upgrade the host device turned to bootload mode when the extender is upgraded. During the upgrade normal operation mode is suspended. When the upgrade is successfully finished, the normal operation mode is restored.

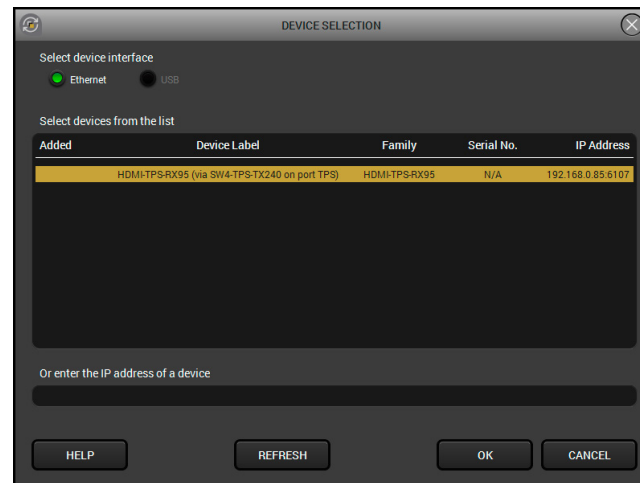





*Remote device in device selection window*

















# 9























## Troubleshooting









Usually, if the system seems not to transport the signal as expected, the best strategy for troubleshooting is to check signal integrity through the whole signal chain starting from source side and moving forward to the receiver end.

-  Link to connections/cabling section.
-  Link to front panel operation section.
-  Link to LDC software section.
-  Link to LW2 protocol commands section.
-  Link to LW3 protocol commands section.

At first, check front panel LEDs and take the necessary steps according to their states. For more information about status, LEDs refer to [Rear Panel Status LEDs](#) and [Front Panel LEDs](#) sections.

Symptom	Root cause	Action	Refer to
<b>Video signal</b>			
<b>No picture on the video output</b>	Device or devices are not powered properly	Check the extenders and the other devices if they are properly powered; try to unplug and reconnect them.	 <a href="#">3.3.5</a>
	Cable connection problem	Cables must fit very well, check all the connectors (video and TPS cables).	 <a href="#">3.3</a>
	TPS mode problem	Check the actual TPS mode and the selected modes of the extenders.	 <a href="#">5.4.4</a>  <a href="#">7.6.21</a>
	The input port is muted	Check the mute state of input port.	 <a href="#">5.4.1</a>  <a href="#">7.6.1</a>
	The output port is muted	Check the mute state of output port.	 <a href="#">5.4.4</a>  <a href="#">6.3.6</a>  <a href="#">7.6.2</a>
	Display is not able to receive the video format	Check the emulated EDID; select another (e.g. emulate the display's EDID on the input port).	 <a href="#">5.6</a>  <a href="#">7.13</a>
	HDCP is disabled	Enable HDCP on the input and output ports.	 <a href="#">5.4.1</a>  <a href="#">5.4.4</a>  <a href="#">7.6.17</a>  <a href="#">7.6.18</a>
<b>Not the desired picture displayed on the video output</b>	Video output is set to test pattern (no sync screen) statically	Check test pattern settings in the properties of the output ports.	 <a href="#">5.4.4</a>  <a href="#">7.6.19</a>
	Video output is set to test pattern (no sync screen) as there is no picture on video source	Check video settings of the source.	

Symptom	Root cause	Action	Refer to
<b>Audio signal</b>			
<b>No audio is present on output</b>	Source audio volume is low or muted	Check the audio settings of the source.	
	Audio input port is muted	Check the audio input port properties	 5.4.2  5.4.3  7.7.1
	Audio output port is muted	Check the output port properties.	 5.4.5  6.3.6  7.7.2
<b>HDMI output signal contains no audio</b>	HDMI mode was set to DVI	Check the properties of the output port and set the signal type to HDMI or Auto.	 5.4.4  7.6.20
	DVI EDID is emulated	Check the EDID and select and HDMI EDID to emulate.	 5.6  7.13
<b>RS-232 signal</b>			
<b>Connected serial device does not respond</b>	Cable connection problem	Check the connectors to fit well; check the wiring of the plugs.	 3.3.7
	RS-232 settings are different	Check the port settings of the transmitter and the connected serial device(s).	 5.7.1  7.9
	RS-232 mode is not right	Check the RS-232 mode settings (control, command injection, or disconnected)	 5.7.1  7.9.6
<b>Network</b>			
<b>No LAN connection can be established</b>	Incorrect IP address is set (fix IP)	Use dynamic IP address by enabling DHCP option.	 4.3.1  5.9.2  7.8.2
		Restore the factory default settings (with fix IP).	 4.3.2  5.9.4  6.2.11  7.5.6
	IP address conflict	Check the IP address of the other devices, too.	

Symptom	Root cause	Action	Refer to
<b>GPIO</b>			
<b>Connected device does not respond</b>	Cable connection problem	Check the connectors to fit well; check the wiring of the plugs.	 3.3.9
<b>Output level cannot be changed</b>	The direction of the selected pin is set to input	Check and modify the direction setting of the desired pin	 5.7.2
			 6.5.1
			 7.12
<b>Miscellaneous</b>			
<b>Front panel buttons are out of operation</b>	Buttons are locked	Unlock the buttons	 4.3.4  5.9.1
<b>Error messages received continuously</b>	Different protocol is set	Check the port protocol settings (LW2 / LW3) and use the proper protocol commands.	 5.7.1
			 7.9.1



# 10

## Technologies

The following sections contain descriptions and useful technical information how the devices work in the background. The content is based on experiences and cases we met in the practice. These sections help to understand features and technical standards like the followings:

- ▶ EDID MANAGEMENT
- ▶ HDCP MANAGEMENT
- ▶ PIXEL ACCURATE RECLOCKING

### 10.1. EDID Management

#### 10.1.1. Understanding the EDID

The Extended Display Identification Data (EDID) is the passport of display devices (monitors, TV sets, projectors). It contains information about the capabilities of the display, such as supported resolutions, refresh rates (these are called Detailed Timings), the type and manufacturer of the display device, etc.

After connecting a source to a display (DVI, HDMI, DP), the source reads out the EDID to determine the resolution and refresh rate of the image to be transmitted.

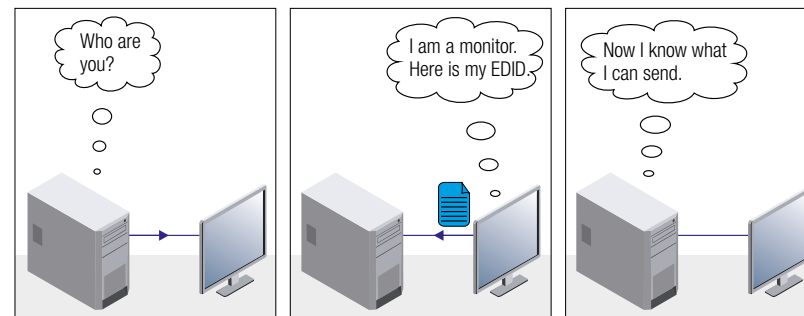

**EDID Communication**

Most DVI computer displays have 128-byte long EDID structure. However, Digital Televisions and HDMI capable displays may have another 128 bytes, which is called E-EDID and defined by CEA (Consumer Electronics Association). This extension contains information about additional Detailed Timings, audio capabilities, speaker allocation and HDMI capabilities. It is important to know that all HDMI capable devices must have CEA extension, but not all devices with CEA extension are HDMI capable.

#### Common Problems Related to EDID

**Problem:** "My system consists of the following: a computer, a Lightware device, a WUXGA (1920x1200) LCD monitor, and an SXGA (1280x1024) projector. I would like to see the same image on the monitor and the projector. What EDID should I choose on the Lightware device?"

**Solution:** If you want to see the image on both displays, you need to select the resolution of the smaller display (in this case SXGA), otherwise the smaller display may not show the higher resolution image.

**Problem:** "I have changed to a different EDID on an input port of the Lightware device to have a different resolution but nothing happens."

**Solution:** Some graphics cards and video sources read out the EDID only after power-up and later they do not sense that EDID has been changed. You need to restart your source to make it read out the EDID again.

#### 10.1.2. Advanced EDID Management

Each DVI sink (e.g. monitors, projectors, plasma displays, etc...) must support the EDID data structure. Source BIOS and operating systems are likely to query the sink using DDC2B protocol to determine what pixel formats and interface are supported. DVI standard uses EDID data structure to identify the monitor type and capabilities. Most DVI sources (VGA cards, set top boxes, etc.) will output DVI signal after accepting the connected sink's EDID information. In the case of EDID readout failure or missing EDID, the source will not output DVI video signal.

Lightware devices provide the Advanced EDID Management function that helps system integration. The built-in EDID Router can store and emulate factory pre-programmed- and User programmable EDIDs. The EDID of the attached monitors or projectors for each output are stored in a non-volatile memory. This way the EDID of a monitor is available when the monitor is unplugged or switched off.

Any EDID can be emulated on any input. An emulated EDID can be copied from the EDID router's memory (static EDID emulation), or from the last attached monitor's memory (dynamic EDID emulation). For example, the Lightware device can be set up to emulate a sink device, which is connected to one of the outputs. In this case, the EDID automatically changes, if the monitor is replaced with another display device (as long as it has a valid EDID).

EDID is independently programmable for all inputs without affecting each other. All inputs have their own EDID circuit.

**INFO:** The user is not required to disconnect the video cable to change an EDID as opposed to other manufacturer's products. EDID can be changed even if a source is connected to the input and powered ON.

**INFO:** When EDID has been changed, the router toggles the HOTPLUG signal for 2 seconds. Some sources do not sense this signal. In such cases, the source device must be restarted or powered OFF and ON again.

## 10.2. HDCP Management

Lightware Visual Engineering is a legal HDCP adopter. Several functions have been developed which helps to solve HDCP related problems. Complex AV systems often have both HDCP and non-HDCP components. The transmitter allows transmitting HDCP encrypted and unencrypted signals. The devices will be still HDCP compliant as they will never output an encrypted signal to a non-HDCP compliant display device. If an encrypted signal is switched to a non-compliant output, a red screen alert or muted screen will appear.

### 10.2.1. Protected and Unprotected Content

Many video sources send HDCP protected signal if they detect that the sink is HDCP capable – even if the content is not copyrighted. This can cause trouble if an HDCP capable device is connected between the source and the display. In this case, the content cannot be viewed on non-HDCP capable displays and interfaces like event controllers. Rental and staging technicians often complain about certain laptops, which are always sending HDCP encrypted signals if the receiver device (display, matrix router, etc.) reports HDCP compliancy. However, HDCP encryption is not required all the time e.g. computer desktop image, certain laptops still do that.

To avoid unnecessary HDCP encryption, Lightware introduced the HDCP enabling/disabling function: the HDCP capability can be disabled in the Lightware device. If HDCP is disabled, the connected source will detect that the sink is not HDCP capable, and turn off authentication.

### 10.2.2. Disable Unnecessary Encryption

#### HDCP Compliant Sink

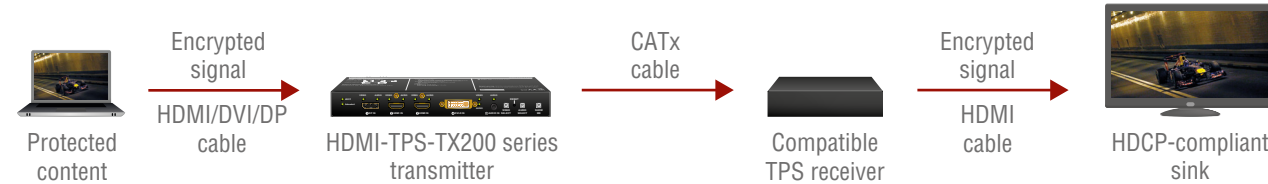

All the devices are HDCP-compliant, no manual setting is required, both protected and unprotected contents are transmitted and displayed on the sink.

#### Not HDCP-compliant Sink 1.

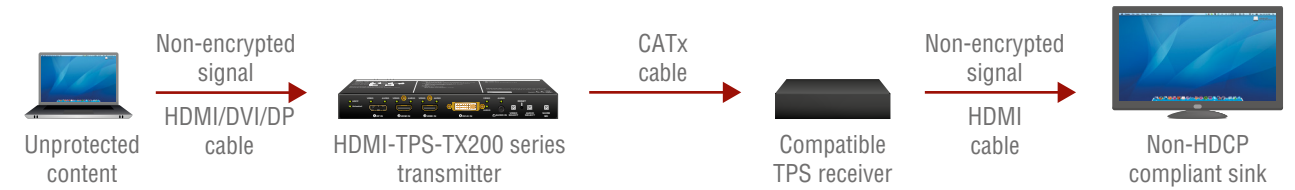

Not-HDCP compliant sink is connected to the receiver. Some sources (e.g. computers) always send HDCP encrypted signals if the receiver device reports HDCP compliancy, however, HDCP encryption is not required all the time (e.g. computer desktop image). If HDCP is enabled in the transmitter, the image will not be displayed on the sink.

Setting the HDCP parameter to Auto on the output port and disable HDCP on the input port, the transmitted signal will not be encrypted if the content is not protected. Thus, non-HDCP compliant sinks will display non-encrypted signal.

#### Not HDCP-compliant Sink 2.

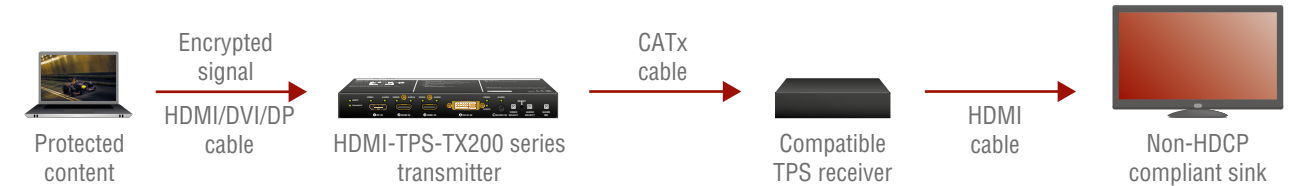

The layout is the same as in the previous case: non-HDCP compliant display device is connected to the receiver but the source would send protected content with encryption. If HDCP is enabled on the input port of the transmitter, the source will send encrypted signal. The sink is not HDCP compliant, thus, it will not display the video signal (but blank/red/muted/etc. screen). If HDCP is disabled on the input port of the transmitter, the source will not send the signal. The solution is to replace the display device to an HDCP-capable one.

### 10.3. Pixel Accurate Reclocking

Signal reclocking is an essential important procedure in digital signal transmission. After passing the reclocking circuit, the signal becomes stable, jitter-free, and can be transmitted over more equipment like processors, or event controllers. Without reclocking, sparkles, noise, and jaggies appear on the image.

Lightware's sophisticated Pixel Accurate Reclocking technology fixes more problems than general TMDS reclocking. It removes not only intra-pair skew but inter-pair skew as well. The Pixel Accurate Reclocking circuit eliminates the following errors:

#### Intra-pair skew

Skew between the + and - wires within a differential wire pair (e.g. Data2- and Data2+). It's caused by different wire lengths or slightly different wire construction (impedance mismatch) in DVI cable. It results in jitter.

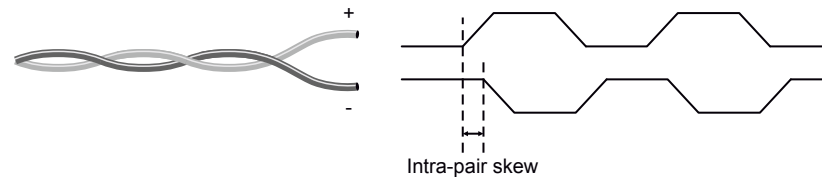

#### Inter-pair skew

Skew between two differential wire pairs in a cable. It is caused by different wire pair lengths or different number of twists in the DVI cable. Too much inter-pair skew results color shift in the picture or sync loss.

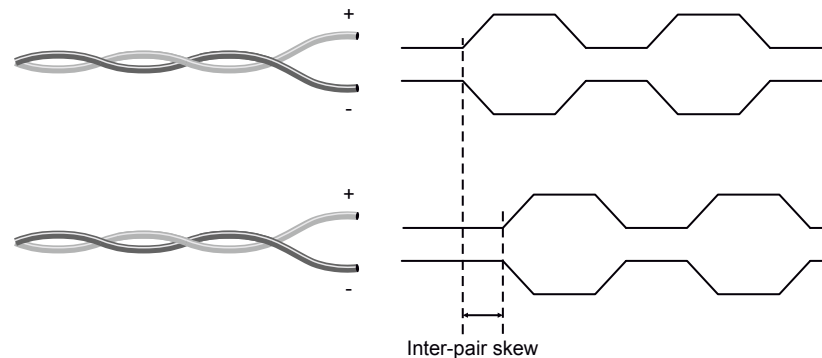

#### Jitter

Signal instability in the time domain. The time difference between two signal transitions should be a fixed value, but noise and other effects cause variations.

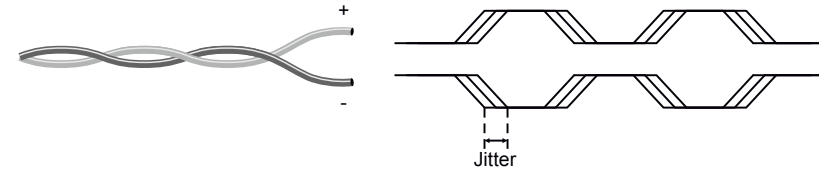

#### Noise

Electromagnetic interference between other electronic devices such as mobile phones, motors, etc. and the DVI cable are coupled onto the signal. Too much noise results in increased jitter.

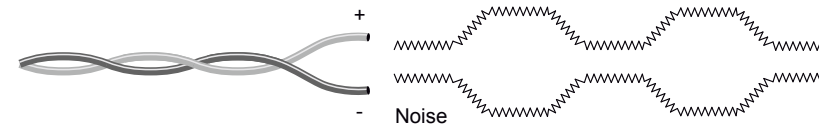

# 11

## Appendix

Tables, drawings, guides, and technical details as follows:

- ▶ [SPECIFICATION](#)
- ▶ [CONTENT OF BACKUP FILE](#)
- ▶ [FACTORY DEFAULT SETTINGS](#)
- ▶ [MAXIMUM EXTENSION DISTANCES](#)
- ▶ [PORT NUMBERING](#)
- ▶ [MECHANICAL DRAWINGS](#)
- ▶ [FACTORY EDID LIST](#)
- ▶ [FURTHER INFORMATION](#)

### 11.1. Specification

#### General

Compliance .....	CE
EMC compliance (emission).....	EN 55032:2015
EMC compliance (immunity).....	EN 55035:2017
Warranty .....	3 years
Cooling.....	Passive
Operating temperature .....	0 to +50°C (+32 to +122°F)
Operating humidity .....	10% to 90%, non-condensing

#### Power

Power supply.....	External power adaptor or PoE remote powering
Power adaptor.....	In 100-240 V AC 50/60 Hz, Out 12V DC, 1 A
Power connector.....	Locking DC connector (2.1 mm pin)
Power over TPS.....	DC 48V, 1A (IEEE 802.3af)
Power consumption - HDMI-TPS-TX210 .....	8 W
Power consumption - HDMI-TPS-TX220 .....	8,5 W
Power consumption - DVI-HDCP-TPS-TX210/TX220.....	8 W
Power consumption - DP-TPS-TX210/TX220 .....	8 W
Power consumption - SW4-TPS-TX240.....	8,5 W

#### Enclosure (UMX-TPS-TX100 series)

Rack mountable .....	Yes
Material.....	1 mm steel
Dimensions in mm.....	221W x 100.4D x 26H
Dimensions in inch .....	8.7 W x 3.95 D x 1.02 H
Weight.....	647 g

#### Video Ports

##### HDMI Input

HDMI port connector type.....	19-pole HDMI Type A receptacle
Standard .....	DVI 1.0, HDMI 1.4
Color depth.....	Deep color support up to 36 bits, 12 bit/color

Color space .....	RGB, YCbCr 4:4:4, YcbCr 4:2:2
Max. video resolutions .....	1600x1200@60 Hz, 36 bit
.....	1920x1080@120 Hz, 24 bit
.....	3840x2160@30 Hz, 24 bit
Audio formats .....	8 channel PCM, Dolby TrueHD,
.....	DTS-HD Master Audio 7.1
Reclocking.....	Pixel Accurate Reclocking
3D support.....	Yes
HDCP compliant.....	Yes, 1.1

##### DisplayPort Input

DisplayPort connector type.....	20-pole, DP 1.1a receptacle
Color depth.....	Deep color support up to 36 bits, 12 bit/color
Color space .....	RGB, YcbCr 4:4:4, YCbCr 4:2:2
Max. video resolutions .....	2560x1600@60 Hz
.....	1920x1080@120 Hz, 24 bit
.....	4096x2400@30 Hz
3D support.....	Yes
HDCP compliant.....	Yes, 1.3

##### DVI-I Input with DVI-D support

Connector type.....	29-pole, DVI-I
Standard .....	DVI 1.0, HDMI 1.4
Color depth.....	Deep color support up to 36 bits, 12 bit/color
Color space .....	RGB, YCbCr 4:4:4, YcbCr 4:2:2
Max. video resolutions .....	1600x1200@60 Hz, 36 bit
.....	1920x1080@120 Hz, 24 bit
.....	3840x2160@30 Hz, 24 bit
Audio formats .....	8 channel PCM
.....	Dolby TrueHD, DTS-HD Master Audio 7.1
Reclocking.....	Pixel Accurate Reclocking
3D support.....	Yes
HDCP compliant.....	Yes, 1.1

**TPS Output Port**

TPS port connector type..... RJ45 connector  
 Compliance .....HDBaseT™  
 Transferred signals..... Video, Audio, RS-232, Infrared, Ethernet  
 Max. video resolutions .....1600x1200@60 Hz, 36 bit  
 ..... 1920x1080@120 Hz, 24 bit  
 .....3840x2160@30 Hz, 24 bit

**HDMI Output**

HDMI port connector type..... 19-pole HDMI Type A receptacle  
 Standard ..... DVI 1.0, HDMI 1.4  
 Color depth.....Deep color support up to 36 bits, 12 bit/color  
 Color space ..... RGB, YCbCr 4:4:4, YcbCr 4:2:2  
 Max. video resolutions .....1600x1200@60 Hz, 36 bit  
 ..... 1920x1080@120 Hz, 24 bit  
 .....3840x2160@30 Hz, 24 bit  
 Audio formats .....8 channel PCM, Dolby TrueHD  
 ..... DTS-HD Master Audio 7.1  
 3D support.....Yes  
 HDCP compliant..... Yes, 1.1

**DVI-D Output**

Connector type.....29-pole, DVI-I  
 Standard ..... DVI 1.0, HDMI 1.4  
 Color depth.....Deep color support up to 36 bits, 12 bit/color  
 Color space ..... RGB, YCbCr 4:4:4, YcbCr 4:2:2  
 Max. video resolutions .....1600x1200@60 Hz, 36 bit  
 ..... 1920x1080@120 Hz, 24 bit  
 .....3840x2160@30 Hz, 24 bit  
 Audio formats .....8 channel PCM, Dolby TrueHD  
 ..... DTS-HD Master Audio 7.1  
 3D support.....Yes  
 HDCP compliant..... Yes, 1.1

**Audio Ports**

**Embedded Audio Signal**

Supported on.....DisplayPort, DVI-D, HDMI ports  
 Supported audio formats .....Up to 8 channel PCM,  
 .....Dolby TrueHD  
 .....DTS HD Master Audio 7.1 formats

**Analog Audio Input (Jack)**

Connector type..... 3.5mm TRS (approx. 1/8" jack)  
 Sampling frequency..... 48 kHz  
 Volume..... -95.62 – 0 dB  
 Maximum input level ..... +0 dBu, 0.77 Vrms, 2.19 Vpp

**Control Ports**

**RS-232**

Connector type..... 3-pole Phoenix connector  
 Available Baud rates .....between 4800 and 115200 baud  
 Available Data bits ..... 8 or 9  
 Available Parity..... None / Odd / Even  
 Available Stop bits .....1 / 1.5 / 2

**Infrared**

Number of IR ports ..... 2 (1x RX, 1x TX)  
 Connector type 1 x 3.5mm TRS and 1 x 3.5mm TS (approx. 1/8" jack)

**Ethernet**

Connector type..... Locking RJ45  
 Ethernet data rate ..... 10/100Base-T, full duplex with autodetect  
 Power over Ethernet (PoE) .....Not supported

**GPIO**

Connector type..... 8-pole Phoenix connector  
 Number of configurable pins ..... 7  
 Port direction..... Input or output  
 Low signal level..... 0 - 0,8 V, max. 30 mA  
 High signal level..... 2 - 5 V, 18 mA

Total available current ..... 180 mA

**EDID Management**

EDID emulation ..... Yes, both on the analog and on the digital inputs  
 EDID memory ..... 120 factory presets, 15 user-programmable

**11.2. Content of Backup File**

The backup file contains numerous settings and parameters saved from the device. When the file is uploaded to a device, the followings will be overwritten:

Digital video input ports (HDMI, DP, DVI-D)
Video port name, Audio port name, HDCP setting
Output ports (TPS and HDMI/DVI-D)
Port name, HDCP mode, HDMI mode, Power +5V mode, Color space setting
Test pattern mode, Test pattern resolution, Test pattern color
Analog audio input port
Port name, Volume, Balance, Gain
Crosspoint settings
Video crosspoint settings, audio crosspoint settings
Autoselect (enable/disable, delay settings, priority list)
Mute/lock state of video ports, Mute/lock state of audio ports
Serial ports (local and TPS)
RS-232 mode, Control protocol, Baud rate, Data bits, Stop bits, Parity
Port name and Command Injection (CI) port number
IR port
Port status (enable / disable), Code length, Repetition code, Modulation state
Input port name, Output port name
CI status (enable / disable), CI port number
Network settings
DHCP status (enable / disable), Static IP address, Network mask, Gateway address, LW2/LW3/HTTP port nr
Further settings
Device label, Control lock
User EDID data (U1-U14), Event Manager: settings of all Events (E1-E20)
GPIO port configuration (pin 1-7)



### 11.3. Factory Default Settings

Parameter	Setting/Value
<b>Crosspoint settings (for SW4-TPS-TX240)</b>	
Video	I1 (DP in)
Audio	I1 (DP in)
<b>Video input port settings (HDMI, DVI-D, DP)</b>	
HDCP	Enabled
Emulated EDID	Dynamic #1: Copy EDID from connected sink device.
<b>Video output port settings (TPS, HDMI)</b>	
Autoselect	Disabled
Test pattern mode	Off
Test pattern resolution	640x480p
Test pattern	Bar
Signal type	Auto
HDCP mode	Auto
Power 5V mode	Always on
TPS mode	Auto
<b>Analog audio input port settings</b>	
Volume	0.00 dB
Balance	50 (center)
Gain	0 dB
<b>Network settings</b>	
IP address	192.168.0.100
Subnet mask	255.255.255.0
Static gateway	192.168.0.1
DHCP	Disabled
LW2 port number	10001
LW3 port number	6107
HTTP port number	80
<b>RS-232 settings</b>	
Control protocol	LW2
Baud rate	57600
Databits	8
Parity	None
Stopbits	1

Parameter	Setting/Value
Operation mode	Pass-through
Command injection status	Enabled
Command injection port nr. - Local	8001
Command injection port nr. - TPS	8002
<b>IR port settings</b>	
Command injection status	Enabled
Comm. inj. input port nr. - Local	9001
Comm. inj. output port nr. - Local	9002
Comm. inj. input port nr. - TPS	9003
Comm. inj. output port nr. - TPS	9004
<b>GPIO port settings</b>	
Direction	Input
Output level	High

### 11.4. Maximum Extension Distances

Resolution	Pixel clock rate	Cable lengths ( Auto / Longreach TPS mode)		
		CAT5e AWG24	CAT7 AWG26**	CAT7 AWG23
1024x768@60Hz	65 MHz	100 m / 130 m*	90 m / 120 m*	120 m / 170 m*
1280x720p@60Hz	73.8 MHz	100 m / 130 m*	90 m / 120 m*	120 m / 170 m*
1920x1080p@60Hz / 24bpp	148.5 MHz	100 m / 130 m*	90 m / 120 m*	120 m / 170 m*
1920x1200@60Hz	152.9 MHz	100 m / NA	90 m / NA	120 m / NA
1600x1200@60Hz	162 MHz	100 m / NA	90 m / NA	120 m / NA
1920x1080@60Hz / 36bpp	223.6 MHz	70 m / NA	70 m / NA	100 m / NA
3840x2160@30Hz UHD	297 MHz	70 m / NA	70 m / NA	100 m / NA
4096x2160@30Hz 4K	297 MHz	70 m / NA	70 m / NA	100 m / NA

\* With Long reach operation mode which supports pixel clock frequencies up to 148.5 MHz.

\*\* When remote powering is used with AWG26 cables, distances are 20% shorter.

## 11.5. Port Numbering

### 11.5.1. For All Models

#### IR and RS-232 Ports

Port name	Port nr. (LW2 / LW3)
Local IR input	S1
Local IR output	D1
TPS IR input	S2
TPS IR output	D2

Port name	Port nr. (LW2 / LW3)
Local serial port	P1
TPS serial link	P2

### 11.5.2. HDMI-TPS-TX210

#### Audio/Video Ports

Port name	Video port nr. (LW2)	Video port nr. (LW3)		Emulated EDID memory	Audio port nr. (LW2)	Audio port nr. (LW3)	
		Till fw v1.0.3	From fw v1.1.0			Till fw v1.0.3	From fw v1.1.0
HDMI in	I1	P1	I1	E1	I1	P1	I1
TPS out	O1	P2	O1	-	O1	P2	O1
HDMI out	O2	P3	O2	-	O2	P3	O2

### 11.5.3. HDMI-TPS-TX220

#### Audio/Video Ports

Port name	Video port nr. (LW2)	Video port nr. (LW3)		Emulated EDID memory	Audio port nr. (LW2)	Audio port nr. (LW3)	
		Till fw v1.0.3	From fw v1.1.0			Till fw v1.0.3	From fw v1.1.0
HDMI in	I1	P1	I1	E1	I1	P1	I1
Audio in	-	-	-	-	I2	P2	I2
TPS out	O1	P2	O1	-	O1	P3	O1
HDMI out	O2	P3	O2	-	O2	P4	O2

### 11.5.4. DVI-HDCP-TPS-TX210

#### Audio/Video Ports

Port name	Video port nr. (LW2)	Video port nr. (LW3)		Emulated EDID memory	Audio port nr. (LW2)	Audio port nr. (LW3)	
		Till fw v1.0.3	From fw v1.1.0			Till fw v1.0.3	From fw v1.1.0
DVI-D in	I1	P1	I1	E1	I1	P1	I1
TPS out	O1	P2	O1	-	O1	P2	O1
DVI-D out	O2	P3	O2	-	O2	P3	O2

### 11.5.5. DVI-HDCP-TPS-TX220

#### Audio/Video Ports

Port name	Video port nr. (LW2)	Video port nr. (LW3)		Emulated EDID memory	Audio port nr. (LW2)	Audio port nr. (LW3)	
		Till fw v1.0.3	From fw v1.1.0			Till fw v1.0.3	From fw v1.1.0
DVI-D in	I1	P1	I1	E1	I1	P1	I1
Audio in	-	-	-	-	I2	P2	I2
TPS out	O1	P2	O1	-	O1	P3	O1
DVI-D out	O2	P3	O2	-	O2	P4	O2

### 11.5.6. DP-TPS-TX210

#### Audio/Video Ports

Port name	Video port nr. (LW2)	Video port nr. (LW3)		Emulated EDID memory	Audio port nr. (LW2)	Audio port nr. (LW3)	
		Till fw v1.0.3	From fw v1.1.0			Till fw v1.0.3	From fw v1.1.0
DP in	I1	P1	I1	E1	I1	P1	I1
TPS out	O1	P2	O1	-	O1	P2	O1
HDMI out	O2	P3	O2	-	O2	P3	O2

### 11.5.7. DP-TPS-TX220

#### Audio/Video Ports

Port name	Video port nr. (LW2)	Video port nr. (LW3)		Emulated EDID memory	Audio port nr. (LW2)	Audio port nr. (LW3)	
		Till fw v1.0.3	From fw v1.1.0			Till fw v1.0.3	From fw v1.1.0
DP in	I1	P1	I1	E1	I1	P1	I1
Audio in	-	-	-	-	I2	P2	I2
TPS out	O1	P2	O1	-	O1	P3	O1
HDMI out	O2	P3	O2	-	O2	P4	O2

### 11.5.8. SW4-TPS-TX240

#### Audio/Video Ports

Port name	Video port nr. (LW2)	Video port nr. (LW3)		Emulated EDID memory	Audio port nr. (LW2)	Audio port nr. (LW3)	
		Till fw v1.0.3	From fw v1.1.0			Till fw v1.0.3	From fw v1.1.0
DP in	I1	P1	I1	E1	I1	P1	I1
HDMI 1 in	I2	P2	I2	E2	I2	P2	I2
HDMI 2 in	I3	P3	I3	E3	I3	P3	I3
DVI-D in	I4	P4	I4	E4	I4	P4	I4
Audio in	-	-	-	-	I5	P5	I5
TPS out	O1	P5	O1	-	O1	P6	O1
HDMI out	O2	P6	O2	-	O2	P7	O2

### 11.6. Mechanical Drawings

SW4-TPS-TX240 can be seen in the pictures, but the dimensions are the same for all the three models. Dimensions are in mm.

#### Front View

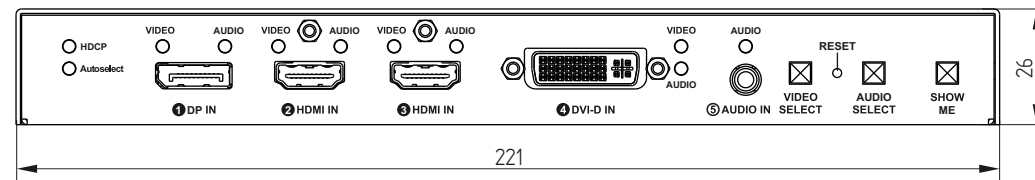

#### Rear View

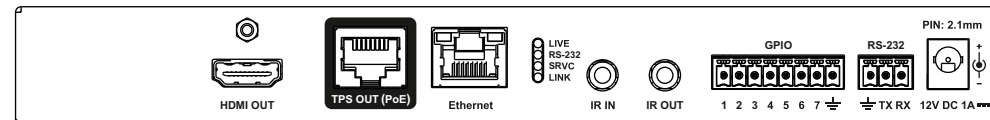

#### Top View

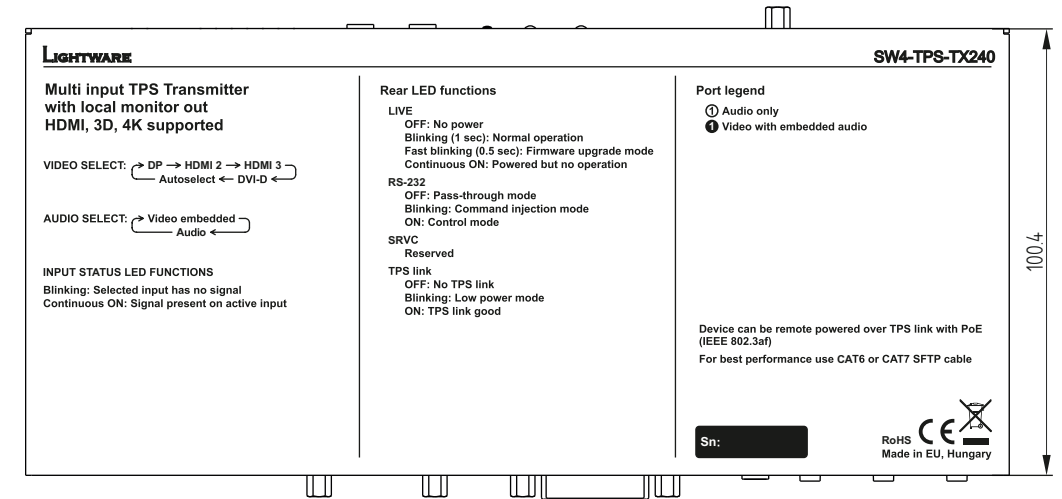

#### Bottom View

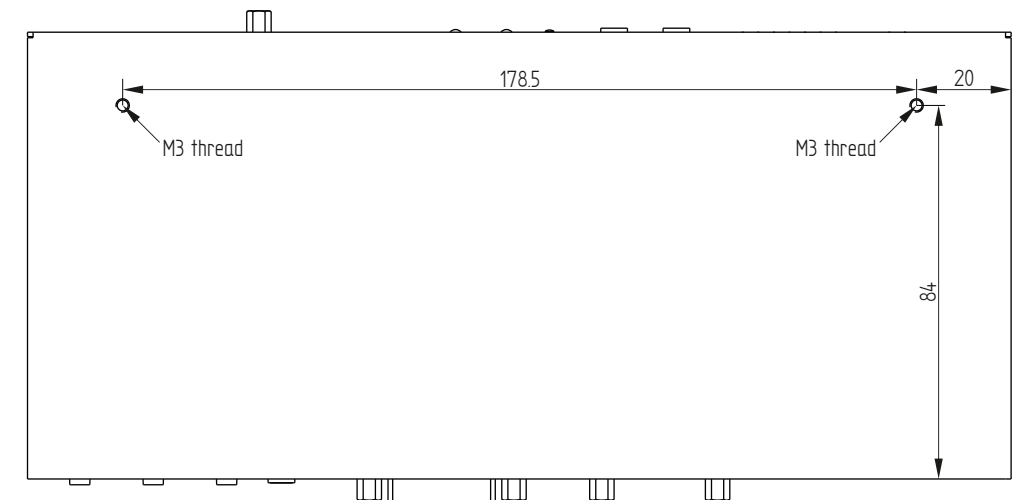

#### Side View

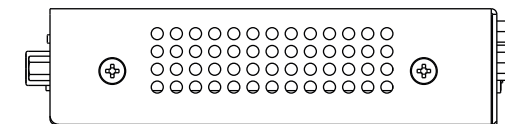

## 11.7. Factory EDID List

Mem.	Resolution				Type	Mem.	Resolution				Type
F1	640 x	480	@ 60.00	Hz	D	F34	720 x	576	@ 50.00	Hz	H
F2	848 x	480	@ 60.00	Hz	D	F35	1280 x	720	@ 50.00	Hz	H
F3	800 x	600	@ 60.32	Hz	D	F36	1280 x	720	@ 60.00	Hz	H
F4	1024 x	768	@ 60.00	Hz	D	F37	1920 x	1080i	@ 50.04	Hz	H
F5	1280 x	768	@ 50.00	Hz	D	F38	1920 x	1080i	@ 50.00	Hz	H
F6	1280 x	768	@ 59.94	Hz	D	F39	1920 x	1080i	@ 60.05	Hz	H
F7	1280 x	768	@ 75.00	Hz	D	F40	1920 x	1080i	@ 60.05	Hz	H
F8	1360 x	768	@ 60.02	Hz	D	F41	1920 x	1080	@ 24.00	Hz	H
F9	1280 x	1024	@ 50.00	Hz	D	F42	1920 x	1080	@ 25.00	Hz	H
F10	1280 x	1024	@ 60.02	Hz	D	F43	1920 x	1080	@ 30.00	Hz	H
F11	1280 x	1024	@ 75.02	Hz	D	F44	1920 x	1080	@ 50.00	Hz	H
F12	1400 x	1050	@ 50.00	Hz	D	F45	1920 x	1080	@ 60.00	Hz	H
F13	1400 x	1050	@ 60.00	Hz	D	F46	1920 x	1080	@ 60.00	Hz	H
F14	1400 x	1050	@ 75.00	Hz	D	F47	Universal_HDMI_PCM				H
F15	1680 x	1050	@ 60.00	Hz	D	F48	Universal_HDMI_ALL				H
F16	1920 x	1080	@ 50.00	Hz	D	F49	Universal_HDMI_DC				H
F17	1920 x	1080	@ 60.00	Hz	D	F50-F89	Reserved				
F18	2048 x	1080	@ 50.00	Hz	D	F90	1920 x	2160	@ 59.99	Hz	D
F19	2048 x	1080	@ 60.00	Hz	D	F91	1024 x	2400	@ 60.01	Hz	D
F20	1600 x	1200	@ 50.00	Hz	D	F92-F93	Reserved				D
F21	1600 x	1200	@ 60.00	Hz	D	F94	2048 x	1536	@ 60.00	Hz	D
F22	1920 x	1200	@ 50.00	Hz	D	F95	Reserved				
F23	1920 x	1200	@ 59.56	Hz	D	F96	2560 x	1600	@ 59.86	Hz	D
F24	2048 x	1200	@ 59.96	Hz	D	F97	3840 x	2400	@ 24.00	Hz	D
F25-F28	Reserved				D	F98	1280 x	720	@ 60.00	Hz	H3D
F29	Universal_DVI				D	F99	1920 x	1080	@ 60.00	Hz	H3D
F30	1440 x	480i	@ 60.05	Hz	H	F100	1024 x	768	@ 60.00	Hz	H
F31	1440 x	576i	@ 50.08	Hz	H	F101	1280 x	1024	@ 50.00	Hz	H
F32	640 x	480	@ 59.95	Hz	H	F102	1280 x	1024	@ 60.02	Hz	H
F33	720 x	480	@ 59.94	Hz	H	F103	1280 x	1024	@ 75.02	Hz	H

Mem.	Resolution				Type	Mem.	Resolution				Type
F104	1600 x	1200	@ 50.00	Hz	H						
F105	1600 x	1200	@ 60.00	Hz	H						
F106	1920 x	1200	@ 59.56	Hz	H						
F107	2560 x	1440	@ 59.95	Hz	H						
F108	2560 x	1600	@ 59.86	Hz	H						
F109	3840 x	2400	@ 24.00	Hz	H						
F110	3840 x	2160	@ 24.00	Hz	H						
F111	3840 x	2160	@ 25.00	Hz	H						
F112	3840 x	2160	@ 30.00	Hz	H						
F113-F117	Reserved										
F118	Universal_4K_PCM				H4K						
F119	Universal_4K_ALL				H4K						
F120	3840 x	2160	@ 60.00	Hz	H4K						

### Legend

Type	Description
D	DVI EDID
H	HDMI EDID
A	Analog EDID
DL	Dual-Link DVI EDID
H3D	HDMI EDID with 3D support
H4K	HDMI EDID with 4K resolution support

## 11.8. Further Information

### Limited Warranty Statement

1. Lightware Visual Engineering LLC (Lightware) warrants to all trade and end user customers that any Lightware product purchased will be free from manufacturing defects in both material and workmanship for three (3) years from purchase unless stated otherwise below. The warranty period will begin on the latest possible date where proof of purchase/delivery can be provided by the customer. In the event that no proof can be provided (empty 'Date of purchase' field or a copy of invoice), the warranty period will begin from the point of delivery from Lightware.

1.1. 25G and MODEX product series will be subject to a seven (7) year warranty period under the same terms as outlined in this document.

1.2. If during the first three (3) months of purchase, the customer is unhappy with any aspect of a Lightware product, Lightware will accept a return for full credit.

1.3. Any product that fails in the first six (6) months of the warranty period will automatically be eligible for replacement and advanced replacement where available. Any replacements provided will be warranted for the remainder of the original unit's warranty period.

1.4. Product failures from six (6) months to the end of the warranty period will either be repaired or replaced at the discretion of Lightware. If Lightware chooses to replace the product then the replacement will be warranted for the remainder of the original unit's warranty period.

2. The above-stated warranty and procedures will not apply to any product that has been:

2.1. Modified, repaired or altered by anyone other than a certified Lightware engineer unless expressly agreed beforehand.

2.2. Used in any application other than that for which it was intended.

2.3. Subjected to any mechanical or electrical abuse or accidental damage.

2.4. Any costs incurred for repair/replacement of goods that fall into the above categories (2.1., 2.2., 2.3.) will be borne by the customer at a pre-agreed figure.

3. All products to be returned to Lightware require a return material authorization number (RMA) prior to shipment and this number must be clearly marked on the box. If an RMA number is not obtained or is not clearly marked on the box, Lightware will refuse the shipment.

3.1. The customer will be responsible for in-bound and Lightware will be responsible for out-bound shipping costs.

3.2. Newly repaired or replaced products will be warranted to the end of the originally purchased products warranty period.

### Document Revision History

Rev.	Release date	Changes	Editor
1.0	03-07-2015	Initial version	Laszlo Zsedenyi
1.1	15-12-2015	Safety instructions updated, CE page pulled out	Laszlo Zsedenyi
1.2	10-06-2016	Major updates for LDC 1.8.0 and LDU 1.3.0, updated Event Manager, changes in LW3 structure.	Tamas Forgacs
2.0	19-09-2017	New document format, updated LW3 prog. ref. chapter	Tamas Forgacs
2.1	14-03-2018	Minor corrections.	Laszlo Zsedenyi
2.2	31-10-2018	1080p120Hz signal support info added.	Laszlo Zsedenyi

### Contact Us

[sales@lightware.com](mailto:sales@lightware.com)

+36 1 255 3800

[support@lightware.com](mailto:support@lightware.com)

+36 1 255 3810

**Lightware Visual Engineering LLC.**  
Peterdy 15, Budapest H-1071, Hungary

[www.lightware.com](http://www.lightware.com)