

Rubix 22

Rubix 24

Rubix 44

USB AUDIO INTERFACE



Reference Manual

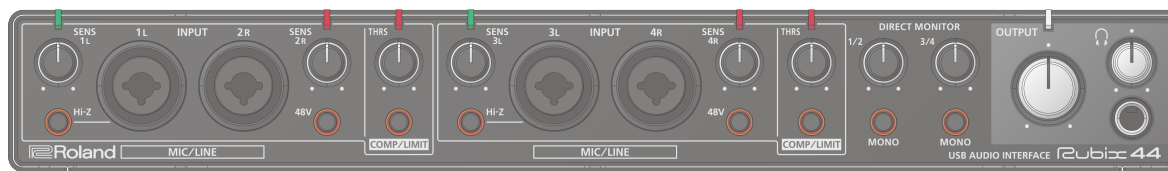

Panel Descriptions

Rubix22

Front Panel

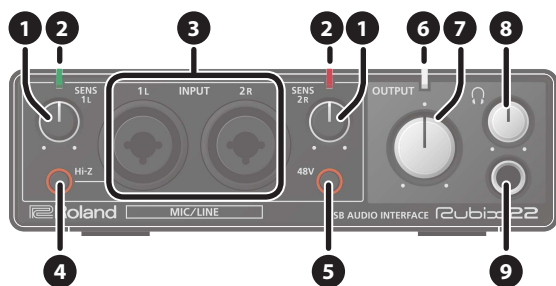

1 [SENS 1L] knob, [SENS 2R] knob

Adjust the volume of the audio signal that is input via the INPUT (1L, 2R) jacks.

2 Level indicator

The indicator is lit green if an audio signal greater than -24 dB (*) is being input to the INPUT (1L, 2R) jacks. If the input level is -3 dB (*) or higher, the indicator is lit red. If the indicator is lit red, use the [SENS 1L] knob and [SENS 2R] knob to adjust the input level.

* The level relative to the maximum allowable input (0 dB)

3 INPUT (1L, 2R) connectors (combo jacks)

These are analog audio input jacks with microphone preamps. They accommodate both XLR connectors and 1/4-inch phone type jacks, and support both balanced and unbalanced connections.

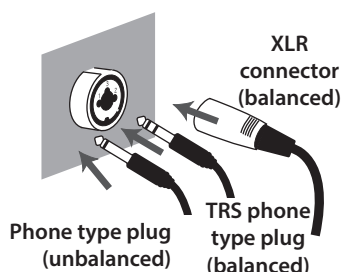

INPUT (1L, 2R) connectors	Input sensitivity
XLR connector	-60~-12dBu
Phone type plug	-44~+4dBu

MEMO

- To prevent malfunction and equipment failure, always turn down the volume, and turn off all the units before making any connections.
- Pin assignment of INPUT connector/jack

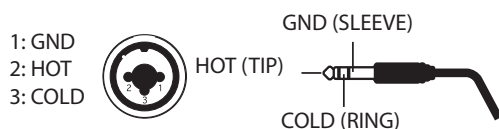

- Set the [Hi-Z] button (p. 2) and [48V] button (p. 2) as appropriate for the audio device that is connected.
- Use a microphone with an XLR connector. The sound level will be very low if you use a microphone with a phone type plug.

- When connecting a guitar or bass, use the INPUT 1L jack. The sound level will be very low if you connect directly to the INPUT 2R jack.



4 [Hi-Z] button

Determines the impedance of the INPUT 1L jack. You can select high impedance (Hi-Z) or low impedance (Lo-Z) as appropriate for the connected equipment.

[Hi-Z] button	Equipment connected to the INPUT 1L jack
Lit (Hi-Z)	Guitar or bass
Unlit (Lo-Z)	Other equipment (such as synthesizers)

5 [48V] button

Determines whether the Rubix22 supplies phantom power to the XLR connectors of the INPUT (1L, 2R) jacks.

[48V] button	Connected equipment
Lit	Condenser microphone that requires phantom power * Phantom power supplied by this unit: DC 48 V; maximum 6 mA. (current value per channel)
Unlit	Other equipment

NOTE

- You must leave the [48V] button set to "OFF" unless condenser microphones requiring phantom power are connected to the XLR connectors. Supplying phantom power to a dynamic microphone or to an audio playback device may damage the equipment. For details on the requirements of your microphone, refer to its owner's manual.
- Minimize the volume before you turn phantom power on or off. Even if the volume is minimized, turning phantom power on/off might make a sound, but this is not a malfunction.

6 Power indicator

Indicates the status of the connection with a USB device.

Power indicator	Status
Lit	Connected to a computer or iPad.
Unlit	Not connected to a computer or iPad.

7 [OUTPUT] knob

Adjusts the output level of the audio signal.

MEMO

Adjusting the [OUTPUT] knob does not change the volume that is output to the (headphones) jack.

8 (Headphone) knob

Adjusts the output level of the jack.

9 (Headphone) jack

Used to connect headphones.

MEMO

This jack outputs the same sound as the OUTPUT (1L, 2R) jacks. Even if headphones are connected, sound will be output from the OUTPUT (1L, 2R) jacks.

Rear Panel

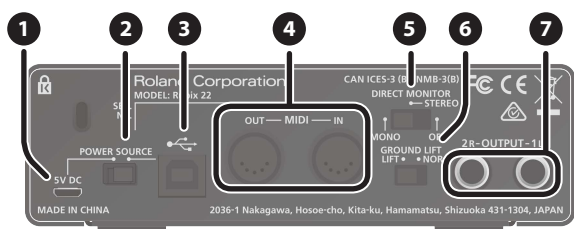

1 5V DC connector

Connect this to a commercially available USB AC adaptor.

About the USB AC adaptor

Read the section on **“Using the Unit Safely”** in the manual included with your USB AC adaptor. Use a USB AC adaptor that meets the following specifications.

- USB micro-B type
- Output voltage: 4.8–5.2 V
- Output current: 500 mA (0.5A) or higher

We have verified that the Rubix operates with typical USB AC adaptors that meet the above conditions, but cannot guarantee that it will work with all adaptors that meet these conditions.

Be aware that even under identical conditions, differences in the design specifications of a USB AC adaptor and differences in the conditions of use might make the Rubix operate or perform differently.

2 [POWER SOURCE] switch

Selects the connector from which power is obtained.

Switch position	Connector from which power is obtained
	5V DC connector (A commercially available USB adaptor is required.)
	USB port (Power is supplied from the connected computer.)

3 USB port ()

Connects to the computer.

4 MIDI (OUT, IN) connectors

Connect the MIDI OUT connector to an external MIDI sound module, etc.

Connect the MIDI IN connector to a MIDI keyboard or MIDI controller.

5 [DIRECT MONITOR] switch

Determines whether the audio signals input via the INPUT (1L, 2R) are output directly.

Switch position	Explanation
MONO	Monitor in mono.
STEREO	Monitor in stereo.
OFF	Select when monitoring using the DAW software. Only audio input via the Rubix22's USB port can be monitored.

MEMO

- When a guitar or microphone is connected to the INPUT 1L jack and nothing is connected to the INPUT 2R jack, set to **“MONO.”**
- Even when set to **“MONO,”** a stereo audio signal is output from the Rubix22's USB port.

6 [GROUND LIFT] switch

Normally, this switch should be set to **“NOR”** (NORMAL).

If ground loop noise occurs, switching this to **“LIFT”** might eliminate the noise.

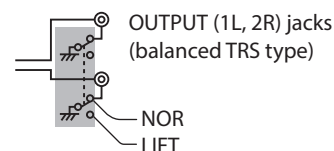

MEMO

- The GND (SLEEVE) of the OUTPUT (1L, 2R) jacks (TRS balanced type) is disconnected from ground.
- In some cases, there might be no sound if you connect a balanced cable to an unbalanced device and set this switch to the **“LIFT”** position. If so, set the switch to **“NOR.”**

7 OUTPUT (1L, 2R) jacks (balanced TRS type)

Output the analog audio signal.

MEMO

- Pin assignment of OUTPUT jack

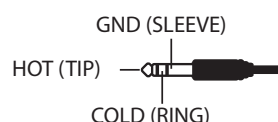

- The wiring of this device uses **“impedance balancing.”** The audio signal is conveyed via HOT and GND in unbalanced form, but since COLD and GND are connected by a resistor, the electrical circuit is balanced. This provides the same noise-reducing effect as a balanced circuit.

Rubix24

Front Panel

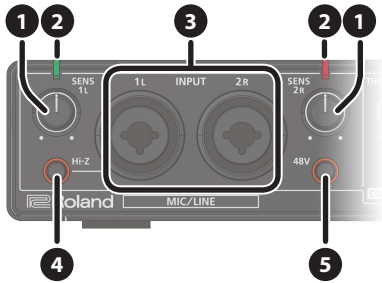

1 [SENS 1L] knob, [SENS 2R] knob

Adjust the volume of the audio signal that is input via the INPUT (1L, 2R) jacks.

2 Level indicator

The indicator is lit green if an audio signal greater than -24 dB (*) is being input to the INPUT (1L, 2R) jacks. If the input level is -3 dB (*) or higher, the indicator is lit red. If the indicator is lit red, use the [SENS 1L] knob and [SENS 2R] knob to adjust the input level.

* The level relative to the maximum allowable input (0 dB)

3 INPUT (1L, 2R) connectors (combo jacks)

These are analog audio input jacks with microphone preamps. They accommodate both XLR connectors and 1/4-inch phone type jacks, and support both balanced and unbalanced connections.

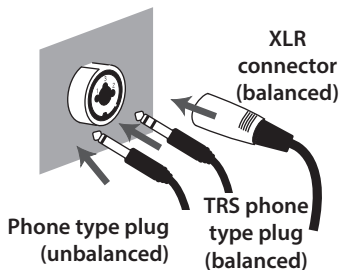

INPUT (1L, 2R) connectors	Input sensitivity
XLR connector	-60~-12dBu
Phone type plug	-44~+4dBu

MEMO

- To prevent malfunction and equipment failure, always turn down the volume, and turn off all the units before making any connections.
- Pin assignment of INPUT connector/jack

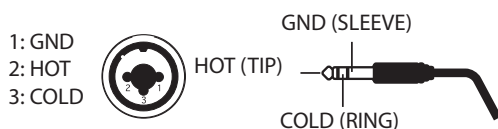

- Set the [Hi-Z] button (p. 4) and [48V] button (p. 4) as appropriate for the audio device that is connected.
- Use a microphone with an XLR connector. The sound level will be very low if you use a microphone with a phone type plug.
- When connecting a guitar or bass, use the INPUT 1L jack. The sound level will be very low if you connect directly to the INPUT 2R jack.

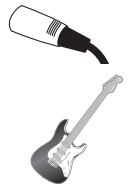

4 [Hi-Z] button

Determines the impedance of the INPUT 1L jack.

You can select high impedance (Hi-Z) or low impedance (Lo-Z) as appropriate for the connected equipment.

[Hi-Z] button	Equipment connected to the INPUT 1L jack
Lit (Hi-Z)	Guitar or bass
Unlit (Lo-Z)	Other equipment (such as synthesizers)

5 [48V] button

Determines whether the Rubix24 supplies phantom power to the XLR connectors of the INPUT (1L, 2R) jacks.

[48V] button	Connected equipment
Lit	Condenser microphone that requires phantom power * Phantom power supplied by this unit: DC 48 V; maximum 6 mA. (current value per channel)
Unlit	Other equipment

NOTE

- You must leave the [48V] button set to **"OFF"** unless condenser microphones requiring phantom power are connected to the XLR connectors. Supplying phantom power to a dynamic microphone or to an audio playback device may damage the equipment. For details on the requirements of your microphone, refer to its owner's manual.
- Minimize the volume before you turn phantom power on or off. Even if the volume is minimized, turning phantom power on/off might make a sound, but this is not a malfunction.

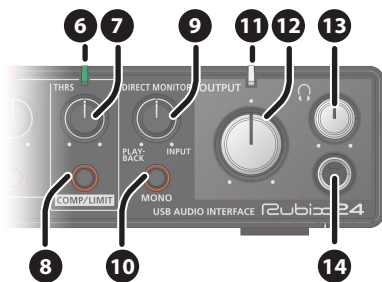

6 Reduction indicator

If the [COMP/LIMIT] button is turned on, this indicator is lit red when the audio input signal exceeds the level specified by the [THRS] knob.

7 [THRS] knob

Specifies the level at which the compressor or limiter will begin operating. As you turn this knob toward the right, the compressor or limiter will be applied more deeply, producing a thicker sound.

8 [COMP/LIMIT] button

Turns the compressor/limiter on/off.

9 [DIRECT MONITOR] knob

Adjusts the balance of the audio signal that is output to the PHONES jack and the OUTPUT (1L, 2R) jacks.

Balance

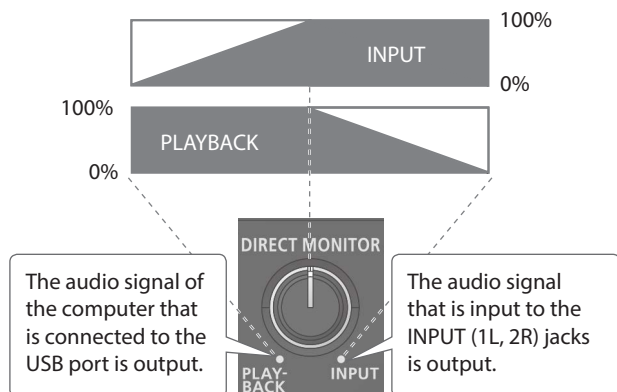

If you're using soft monitoring on your DAW, set this to **"PLAYBACK."**

MEMO

Sometimes you might hear noise when turning this knob, but this is not a malfunction.

10 [MONO] button

If this is turned on, the audio signal that is input to the INPUT (1L, 2R) jacks is monitored in mono.

MEMO

- When a guitar or microphone is connected to the INPUT 1L jack and nothing is connected to the INPUT 2R jack, set the [MONO] button to **"ON."**
- Even when set to **"MONO,"** a stereo audio signal is output from the Rubix24's USB port.

11 Power indicator

Indicates the status of the connection with a USB device.

Power indicator	Status
Lit	Connected to a computer or iPad.
Unlit	Not connected to a computer or iPad.

12 [OUTPUT] knob

Adjusts the output level of the audio signal.

MEMO

Adjusting the [OUTPUT] knob does not change the volume that is output to the (headphones) jack or the OUTPUT (3L, 4R) jacks.

13 (Headphone) knob

Adjusts the output level of the jack.

14 (Headphone) jack

Used to connect headphones.

The audio signal selected by the [PHONES SOURCE] switch is output.

MEMO

Even if headphones are connected, sound will be output from the OUTPUT (1L, 2R) and OUTPUT (3L, 4R) jacks.

Rear Panel

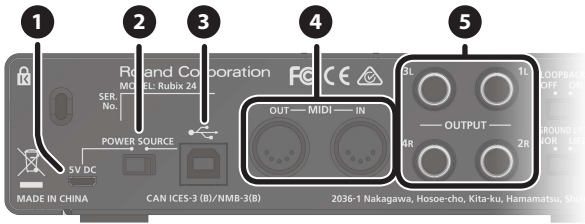

1 5V DC connector

Connect this to a commercially available USB AC adaptor.

About the USB AC adaptor

Read the section on **“Using the Unit Safely”** in the manual included with your USB AC adaptor. Use a USB AC adaptor that meets the following specifications.

- USB micro-B type
- Output voltage: 4.8–5.2 V
- Output current: 1 A or higher

We have verified that the Rubix operates with typical USB AC adaptors that meet the above conditions, but cannot guarantee that it will work with all adaptors that meet these conditions.

Be aware that even under identical conditions, differences in the design specifications of a USB AC adaptor and differences in the conditions of use might make the Rubix operate or perform differently.

2 [POWER SOURCE] switch

Selects the connector from which power is obtained.

Switch position	Connector from which power is obtained
	5V DC connector (A commercially available USB adaptor is required.)
	USB port (Power is supplied from the connected computer.)

3 USB port ()

Connects to the computer.

4 MIDI (OUT, IN) connectors

Connect the MIDI OUT connector to an external MIDI sound module, etc.

Connect the MIDI IN connector to a MIDI keyboard or MIDI controller.

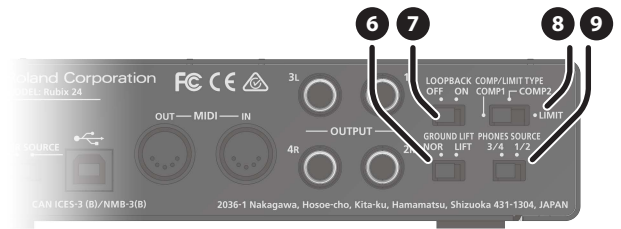

5 OUTPUT (1L, 2R, 3L, 4R) jacks (balanced TRS type)

Output the analog audio signal.

MEMO

- Pin assignment of OUTPUT jack

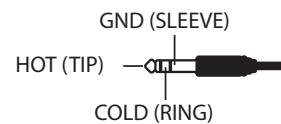

- The wiring of this device uses **“impedance balancing.”** The audio signal is conveyed via HOT and GND in unbalanced form, but since COLD and GND are connected by a resistor, the electrical circuit is balanced. This provides the same noise-reducing effect as a balanced circuit.

6 [GROUND LIFT] switch

Normally, this switch should be set to **“NOR”** (NORMAL).

If ground loop noise occurs, switching this to **“LIFT”** might eliminate the noise.

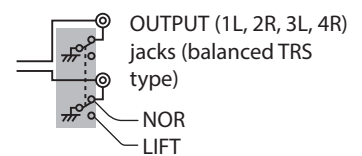

MEMO

- The GND (SLEEVE) of the OUTPUT (1L, 2R, 3L, 4R) jacks (TRS balanced type) is disconnected from ground.
- In some cases, there might be no sound if you connect a balanced cable to an unbalanced device and set this switch to the **“LIFT”** position. If so, set the switch to **“NOR”**.

7 [LOOPBACK] switch

If this is turned on, the audio signal that is input to the INPUT (1L, 2R) jacks is mixed with the audio signal played back from the computer, and this mixed signal is then sent back (returned) to the computer. You can use this for live broadcasting to the internet.

MEMO

If you intend to turn the [LOOPBACK] switch on, you should turn off your DAW software’s monitor function and the monitoring function of Windows. Failing to do this will cause oscillation (feedback) or doubling of the input sound.

8 [COMP/LIMIT TYPE] switch

Switches the response of the built-in compressor/limiter circuit (p. 19).

9 [PHONES SOURCE] switch

Selects the audio signal that is monitored in headphones.

Switch position	Explanation
1/2	Monitor the output of OUTPUT (1L, 2R).
3/4	Monitor the output of OUTPUT (3L, 4R).

Rubix44

Front Panel

MEMO

The following explanation and illustration covers the INPUT (1L, 2R) jack section. The Rubix44 additionally has INPUT (3L, 4R) jacks with placement and functionality that are equivalent to the INPUT (1L, 2R) jacks. This explanation applies in the same way to the INPUT (3L, 4R) jack section.

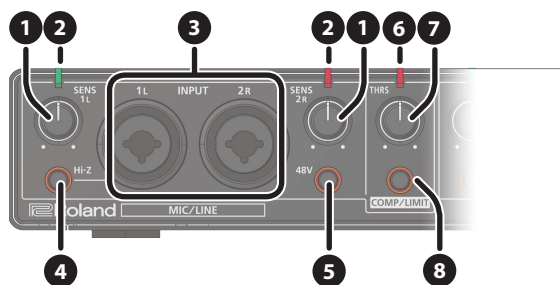

1 [SENS 1L] knob, [SENS 2R] knob

Adjust the volume of the audio signal that is input via the INPUT (1L, 2R) jacks.

2 Level indicator

The indicator is lit green if an audio signal greater than -24 dB (*) is being input to the INPUT (1L, 2R) jacks. If the input level is -3 dB (*) or higher, the indicator is lit red. If the indicator is lit red, use the [SENS 1L] knob and [SENS 2R] knob to adjust the input level.

* The level relative to the maximum allowable input (0 dB)

3 INPUT (1L, 2R) connectors (combo jacks)

These are analog audio input jacks with microphone preamps. They accommodate both XLR connectors and 1/4-inch phone type jacks, and support both balanced and unbalanced connections.

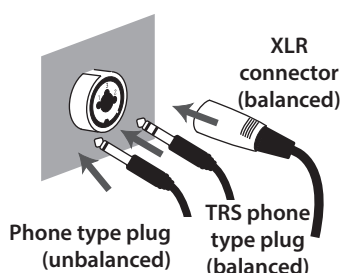

INPUT (1L, 2R) connectors	Input sensitivity
XLR connector	-60--12dBu
Phone type plug	-44--+4dBu

MEMO

- To prevent malfunction and equipment failure, always turn down the volume, and turn off all the units before making any connections.
- Pin assignment of INPUT connector/jack

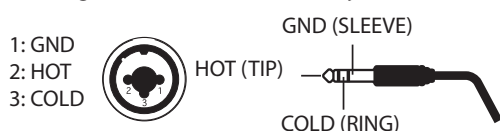

- Set the [Hi-Z] button (p. 7) and [48V] button (p. 7) as appropriate for the audio device that is connected.

- Use a microphone with an XLR connector. The sound level will be very low if you use a microphone with a phone type plug.



- When connecting a guitar or bass, use the INPUT 1L or INPUT 3L jack. The sound level will be very low if you connect directly to the INPUT 2R or INPUT 4R jack.

4 [Hi-Z] button

Determines the impedance of the INPUT 1L jack.

You can select high impedance (Hi-Z) or low impedance (Lo-Z) as appropriate for the connected equipment.

[Hi-Z] button	Equipment connected to the INPUT 1L jack
Lit (Hi-Z)	Guitar or bass
Unlit (Lo-Z)	Other equipment (such as synthesizers)

5 [48V] button

Determines whether the Rubix44 supplies phantom power to the XLR connectors of the INPUT (1L, 2R) jacks.

[48V] button	Connected equipment
Lit	Condenser microphone that requires phantom power * Phantom power supplied by this unit: DC 48 V; maximum 6 mA. (current value per channel)
Unlit	Other equipment

NOTE

- You must leave the [48V] button set to "OFF" unless condenser microphones requiring phantom power are connected to the XLR connectors. Supplying phantom power to a dynamic microphone or to an audio playback device may damage the equipment. For details on the requirements of your microphone, refer to its owner's manual.
- Minimize the volume before you turn phantom power on or off. Even if the volume is minimized, turning phantom power on/off might make a sound, but this is not a malfunction.

6 Reduction indicator

If the [COMP/LIMIT] button is turned on, this indicator is lit red when the audio input signal exceeds the level specified by the [THRS] knob.

7 [THRS] knob

Specifies the level at which the compressor or limiter will begin operating. As you turn this knob toward the right, the compressor or limiter will be applied more deeply, producing a thicker sound.

8 [COMP/LIMIT] button

Turns the compressor/limiter on/off.

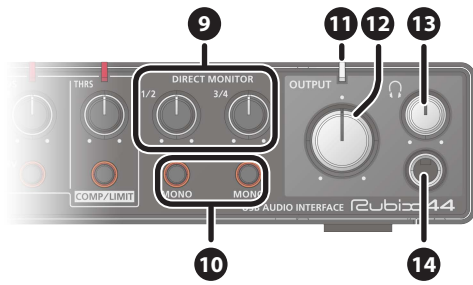

9 DIRECT MONITOR [1/2], [3/4] knobs

Adjust the balance at which the audio signals that are input to the INPUT (1L, 2R) jacks and INPUT (3L, 4R) jacks are output to OUTPUT (1L, 2R).

When using soft monitoring on your DAW, turn these knobs all the way to the left.

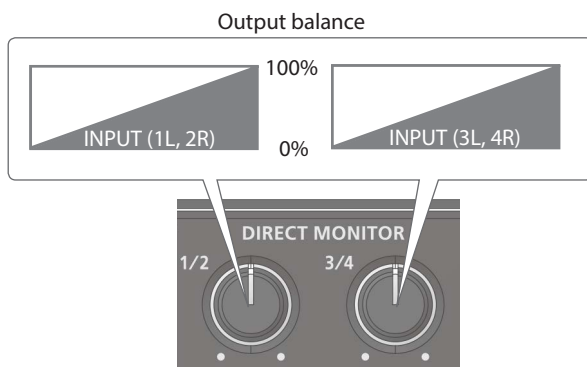

MEMO

Sometimes you might hear noise when turning this knob, but this is not a malfunction.

10 [MONO] button

If this is turned on, the audio signal that is input to the INPUT (1L, 2R) jacks (or INPUT (3L, 4R) jacks) is monitored in mono.

MEMO

- When a guitar or microphone is connected to the INPUT 1L jack and nothing is connected to the INPUT 2R jack, set the [MONO] button to "ON."
- Even when set to "MONO," a stereo audio signal is output from the Rubix44's USB port.

11 Power indicator

Indicates the status of the connection with a USB device.

Power indicator	Status
Lit	Connected to a computer or iPad.
Unlit	Not connected to a computer or iPad.
Rapid blinking	The power will soon be turned off automatically by the auto power off function.

MEMO

This unit automatically powers-off in the following conditions (Auto Off function).

- The unit is not connected to a computer or tablet
- There has been no audio input for 10 hours

Five minutes before the power turns off automatically, the power indicator blinks rapidly. After the unit switches off, turn the power on if you want to use the Rubix44 again.

12 [OUTPUT] knob

Adjusts the output level of the audio signal.

MEMO

Adjusting the [OUTPUT] knob does not change the volume that is output to the Ω (headphones) jack or the OUTPUT (3L, 4R) jacks.

13 [Ω] (Headphone) knob

Adjusts the output level of the Ω jack.

14 Ω (Headphone) jack

Used to connect headphones.

The audio signal selected by the [PHONES SOURCE] switch is output.

MEMO

Even if headphones are connected, sound will be output from the OUTPUT (1L, 2R) jacks.

Rear Panel

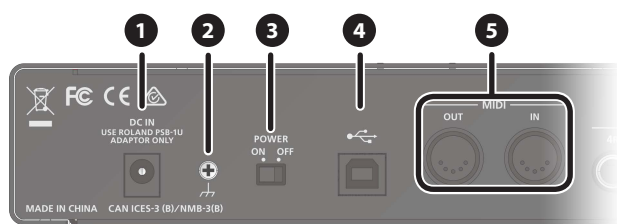

1 DC IN jack

Connect the included AC adaptor here.

2 Ground terminal

Depending on the circumstances of a particular setup, you may experience a discomforting sensation, or perceive that the surface feels gritty to the touch when you touch this device, microphones connected to it, or the metal portions of other objects, such as guitars. This is due to an infinitesimal electrical charge, which is absolutely harmless. However, if you are concerned about this, connect the ground terminal with an external ground. When the unit is grounded, a slight hum may occur, depending on the particulars of your installation. If you are unsure of the connection method, contact the nearest Roland Service Center, or an authorized Roland distributor, as listed on the “**Information**” page.

* Unsuitable places for connection

- Water pipes (may result in shock or electrocution)
- Gas pipes (may result in fire or explosion)
- Telephone-line ground or lightning rod (may be dangerous in the event of lightning)

3 [POWER] switch

Turns the power of the Rubix on/off.

Concerning the Auto Off function

This unit automatically powers-off in the following conditions (Auto Off function).

- The unit is not connected to a computer or tablet
- There has been no audio input for 10 hours

If you don't want the unit to power-off automatically, connect it to a computer or tablet.

4 USB port ()

Connects to the computer.

MEMO

The Rubix44 cannot be powered via its USB port (it will not operate).

5 MIDI (OUT, IN) connectors

Connect the MIDI OUT connector to an external MIDI sound module, etc.

Connect the MIDI IN connector to a MIDI keyboard or MIDI controller.

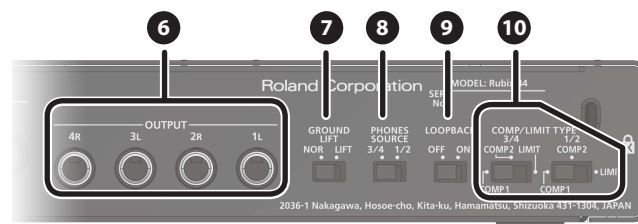

6 OUTPUT (1L, 2R, 3L, 4R) jacks (balanced TRS type)

Output the analog audio signal.

MEMO

- Pin assignment of OUTPUT jack

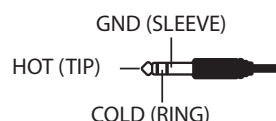

- The wiring of this device uses “**impedance balancing**.” The audio signal is conveyed via HOT and GND in unbalanced form, but since COLD and GND are connected by a resistor, the electrical circuit is balanced. This provides the same noise-reducing effect as a balanced circuit.

7 [GROUND LIFT] switch

Normally, this switch should be set to “**NOR**” (NORMAL).

If ground loop noise occurs, switching this to “**LIFT**” might eliminate the noise.

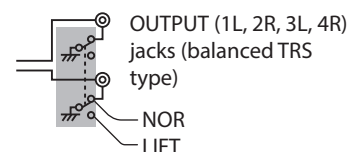

MEMO

- The GND (SLEEVE) of the OUTPUT (1L, 2R, 3L, 4R) jacks (TRS balanced type) is disconnected from ground.
- In some cases, there might be no sound if you connect a balanced cable to an unbalanced device and set this switch to the “**LIFT**” position. If so, set the switch to “**NOR**.”

8 [PHONES SOURCE] switch

Selects the audio signal that is monitored in headphones.

Switch position	Explanation
1/2	Monitor the output of OUTPUT (1L, 2R).
3/4	Monitor the output of OUTPUT (3L, 4R).

9 [LOOPBACK] switch

If this is turned on, the audio signal that is input to the INPUT (1L, 2R) jacks and INPUT (3L, 4R) jacks is mixed with the audio signal played back from the computer, and this mixed signal is then sent back (returned) to the computer. You can use this for live broadcasting to the internet.

MEMO

If you intend to turn the [LOOPBACK] switch on, you should turn off your DAW software's monitor function and the monitoring function of Windows. Failing to do this will cause oscillation (feedback) or doubling of the input sound.

10 [COMP/LIMIT TYPE] switch

Switches the response of the built-in compressor/limiter circuit (p. 19).

Getting Ready to Use the Rubix

Connecting to a Windows 10 Computer

If you're using Windows 10, access the following URL to check the latest information.

➔ <http://roland.cm/rubix/>

Connecting to a Windows 8.1 / Windows 8 / Windows 7 Computer

If you're using this product with Windows 8.1, Windows 8, or Windows 7, install the driver

In order to use this product, you must download and install the driver.

For details on installation, refer to **"Installing the USB Driver (Before Using the Product for the First Time)"** (p. 10) and **"Connecting to a Computer"** (p. 11).

NOTE

Install the driver before connecting this product to your computer. If you've already connected this product to your computer, temporarily disconnect it before you proceed.

Installing the USB Driver (Before Using the Product for the First Time)

1. With the Rubix22 / Rubix24 / Rubix44 not connected, start up your computer.
2. Download the USB driver from the Roland website, and begin the installation as directed below.

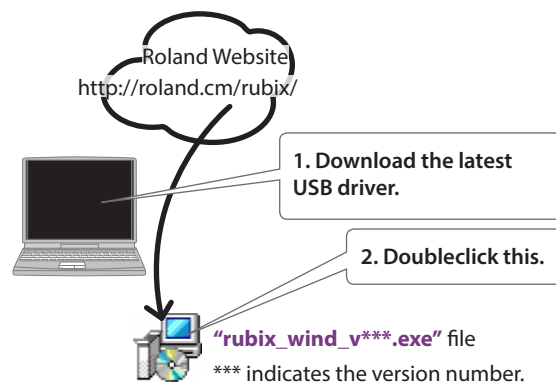

3. Follow the on-screen directions to install the USB driver.

NOTE

Don't connect the Rubix22 / Rubix24 / Rubix44 to your computer until USB driver installation has ended.

MEMO

- If a Windows security dialog box appears, click the **[Install]** button.
- If an **"Install software"** dialog box appears, click the **[Continue]** button.
- If any other message appears, proceed as directed by the message.

4. As described in **"Connecting to a Computer"** (p. 11), connect the Rubix22 / Rubix24 / Rubix44 to your computer.

Connecting to a Computer

After you have finished installing the USB driver in your computer, connect the product to your computer as follows.

- * To prevent malfunction and equipment failure, always turn down the volume, and turn off all the units before making any connections.
- * Once everything is properly connected, be sure to follow the procedure below to turn on their power. If you turn on equipment in the wrong order, you risk causing malfunction or equipment failure.

MEMO

After you install the USB driver and connect the Rubix22 / Rubix24 / Rubix44 to your computer for the first time, it might take several minutes before the Rubix is ready to use.

Rubix22 / Rubix24 users

- * The illustration shows the Rubix22

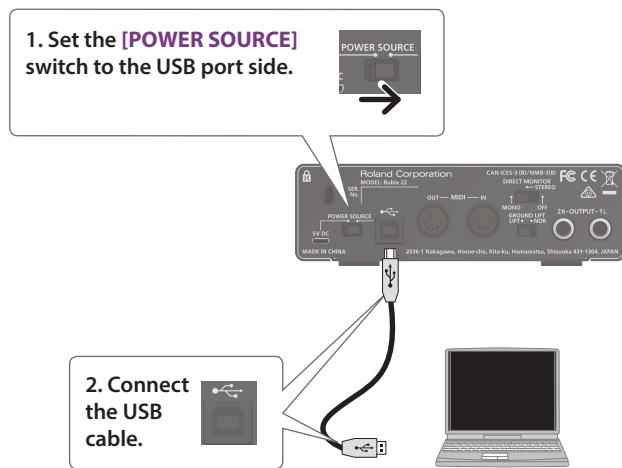

Rubix44 users

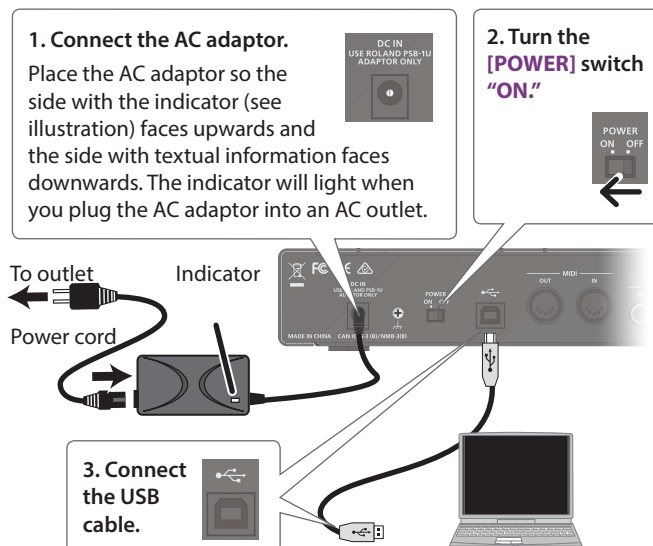

Connecting to a Mac

- * To prevent malfunction and equipment failure, always turn down the volume, and turn off all the units before making any connections.
- * Once everything is properly connected, be sure to follow the procedure below to turn on their power. If you turn on equipment in the wrong order, you risk causing malfunction or equipment failure.

If you're using a Mac, you don't need to install a USB driver.

Rubix22 / Rubix24 users

- * The illustration shows the Rubix22

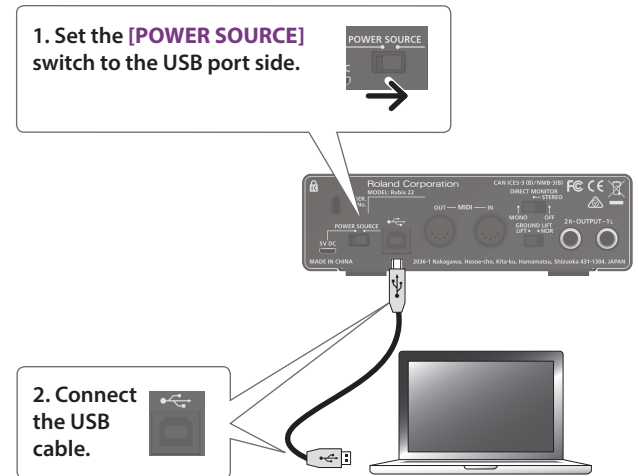

Rubix44 users

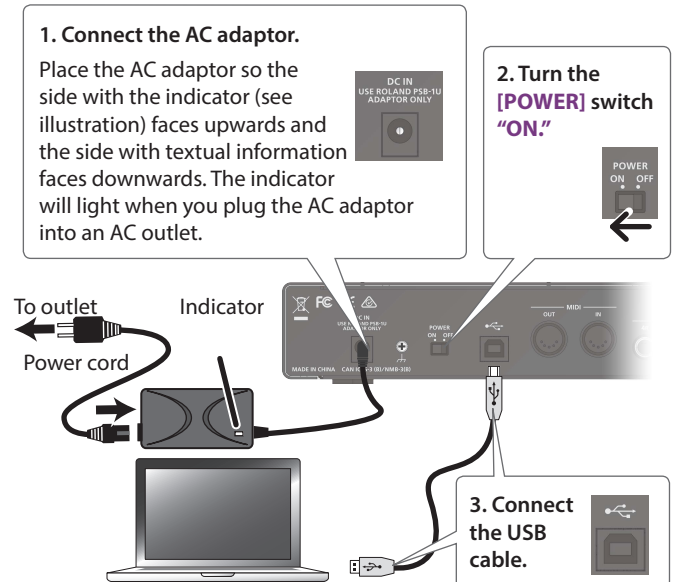

Connecting to an iPad

- * To prevent malfunction and equipment failure, always turn down the volume, and turn off all the units before making any connections.
- * Once everything is properly connected, be sure to follow the procedure below to turn on their power. If you turn on equipment in the wrong order, you risk causing malfunction or equipment failure.

If you're using an iPad, you don't need to install a USB driver.

Rubix22 / Rubix24 users

* The illustration shows the Rubix22

1. Connect the USB AC adaptor (or mobile battery) using a USB micro-B type ↔ A type cable (all commercially available items).

2. Set the [POWER SOURCE] switch to the 5V DC connector side.

3. Connect the USB cable.

Apple Inc.'s Lightning to USB Camera Adapter (sold separately)

Rubix44 users

1. Connect the AC adaptor.
Place the AC adaptor so the side with the indicator (see illustration) faces upwards and the side with textual information faces downwards. The indicator will light when you plug the AC adaptor into an AC outlet.

2. Turn the [POWER] switch "ON."

3. Connect the USB cable.

Uninstalling the Driver (Windows Only)

1. With all USB devices disconnected except for a keyboard and mouse, start Windows.

Also disconnect the Rubix's USB cable.

2. Exit all applications before you uninstall.

Wait approximately ten seconds for the applications to exit completely.

3. If you're using Windows 10, right-click the [Start] button → click "Apps and Features."

If you're using Windows 7/8/8.1, click the [Start] button → "Control Panel" → "Uninstall a Program."

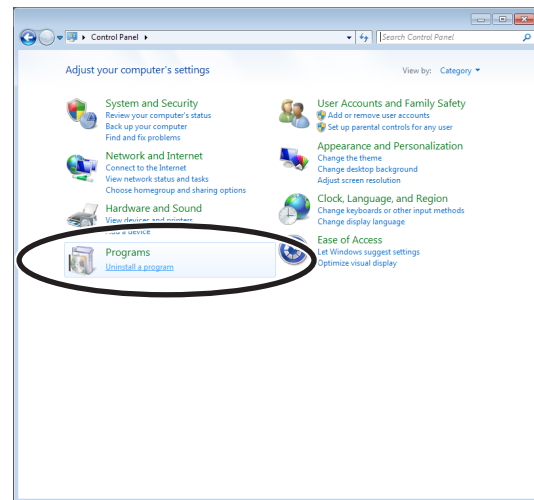

If "icon view" is selected for the control panel, click "Programs and Functions."

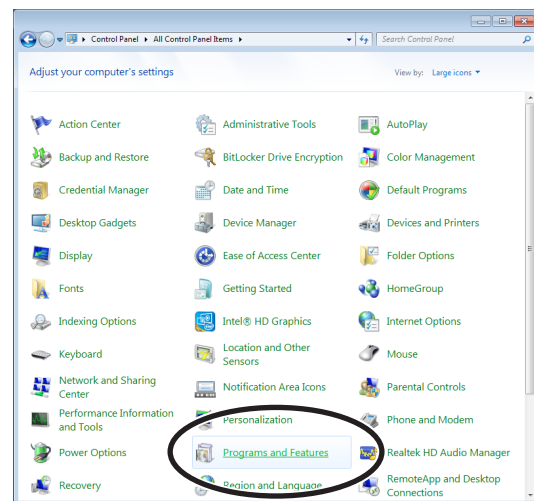

4. In the list, click "Roland USB Audio Driver for Rubix Series," and then click "Uninstall."

If you don't see "Roland USB Audio Driver for Rubix Series" in the list, the driver is not installed on your computer.

5. If a user account control dialog box appears, click [Yes].

If you are asked to enter a password for an administrator account, log on to Windows as a user whose account type is "administrator," and make the settings again.

6. Follow the directions in the screen to uninstall the USB driver.

If any other message appears, proceed as directed by the message.

About the USB Driver

Windows Operating Requirements

Supported Operating Systems

Microsoft® Windows® 7 / 8 / 8.1 / 10 (64-bit / 32-bit)

- * The driver does not work on Windows RT.

Supported Computers

A Windows compatible computer equipped with a USB port

- * We recommend a chipset made by Intel.
- * Intel Core2 processor 1.6 GHz or faster, RAM 1.0 GB or more
- * Performance might be unsatisfactory if this unit is used with a USB 2.0 interface card.
- * This unit cannot be used with a USB 3.0 port that is not compatible with USB 2.0.
- * If the unit does not operate correctly when connected to a USB 3.0 port, you'll need to connect it to a USB 2.0 port.
- * Even if the unit is connected to a USB 3.0 port, the performance of the unit itself will not change.
- * This unit cannot be used in a virtual Windows environment such as VMware or VirtualBox.
- * Mac computers running Windows are not supported.

Limitations and Cautions

- Depending on the performance and design specifications of the computer you're using, and on the applications you're using and how you're using them, clicks and pops might occur in the sound.
- If you start your computer with a powered-on Rubix already connected to the computer, the driver might not be loaded correctly, making it impossible to use the Rubix. If this occurs, try the following.
 - Reconnect the Rubix to a different USB port
 - Power-on the Rubix after the computer has started
 - Disconnect and reconnect the USB cable
- Sometimes the Rubix might not operate correctly after returning from a sleep state. If this occurs, try the following.
 - Exit all the applications you're using, and power-cycle the Rubix
 - Disconnect and reconnect the USB cable
- If you disconnect and reconnect the USB cable while using the Rubix, or power-cycle the Rubix, it might stop operating correctly. If this occurs, try the following.
 - Exit all the applications you're using, and power-cycle the Rubix
 - Disconnect and reconnect the USB cable
- If a high processing load occurs while using the Rubix, such as accessing a CD-ROM drive or the network, it might not operate correctly. If this occurs, try the following.
 - Stop playback/recording, and then resume playback/recording
 - Exit all the applications you're using, and power-cycle the Rubix
 - Disconnect and reconnect the USB cable
- If you connect or disconnect another USB device (such as a USB flash drive) while using the Rubix, or turn the power of another USB device on or off, clicks or pops might occur during playback or recording.

- In some cases, performance might be unsatisfactory if the Rubix is used simultaneously with a USB-connected hard disk. Don't use a USB-connected hard disk as the save-destination for playback or recording.

Mac OS Operating Requirements

Supported Operating Systems

OS X v10.12 / v10.11 / v10.10

- * Check the operating requirements of your audio/MIDI application as well as the operating requirements for your operating system.

Supported Computers

Apple Mac series computer equipped with a USB port

- * Even if the unit is connected to a USB 3.0 port, the performance of the unit itself will not change.
- * Mac computers running Windows are not supported.

Limitations and Cautions

- Connect the Rubix to your computer with a USB cable before starting your sequencer software, etc.
- Don't power-off the Rubix or disconnect the USB cable during playback/recording. Doing so might cause the software or operating system to shut down abnormally.
- Exit your sequencer software etc. before you power-off the Rubix or disconnect the USB cable.
- Before updating the operating system software, disconnect the USB cable from the Rubix.
- If the Rubix does not operate correctly after returning from sleep or after restarting the operating system, try the following.
 - Exit all the applications you're using, and power-cycle the Rubix
 - Disconnect and reconnect the USB cable

iPad Operating Requirements

Supported Operating Systems

iOS 9.0 or later

Limitations and Cautions

- Connect the Rubix to your iPad with a USB cable before starting your sequencer software, etc.
- Don't power-off the Rubix or disconnect the USB cable during playback/recording. Doing so might cause the software or operating system to shut down abnormally.
- Exit your sequencer software etc. before you power-off the Rubix or disconnect the USB cable.
- Before updating the iOS software, disconnect the USB cable from the Rubix.
- If the Rubix does not operate correctly after restarting iOS, try the following.
 - Exit all the applications you're using, and power-cycle the Rubix
 - Disconnect and reconnect the USB cable

Settings for the Rubix

Input / Output Device Settings

In the DAW application that you're using, make settings for playing and recording audio and MIDI. For details on how to make these settings, refer to the owner's manual of your DAW application.

Audio Driver	Audio Input Device / Audio Output Device
MME, WDM/KS	IN (Roland Rubix22) / OUT (Roland Rubix22) (*1)
ASIO	Roland Rubix

(*1) Select the model of Rubix that you're using.

MEMO

The Rubix22 / Rubix24 / Rubix44 support sample rates of 44.1 kHz, 48 kHz, 96 kHz, and 192 kHz.

MIDI Input Device / MIDI Output Device

Roland Rubix22 (*2)

(*2) Select the model of Rubix that you're using.

OS Settings

Windows

1. Open "Control Panel," click the [Hardware and Sound] icon, and then click the [Sound] icon.

If you're using the icon view or the classic view, double-click the [Sound] icon.

2. Click the [Playback] tab, choose Rubix22 / Rubix24 / Rubix44 [OUT], and click the [Set as default] button.
3. Click the [OK] button.

Mac OS

1. Open "System Preferences," and click the [Sound] icon.
 2. Click the [Output] tab, and select [Rubix22] (*3).
- (*3) Select the model of Rubix that you're using.
3. When you have finished making settings, close "System Preferences."

Check Whether You Hear Sound

1. As shown in the illustration, connect your headphones or amplified speakers.

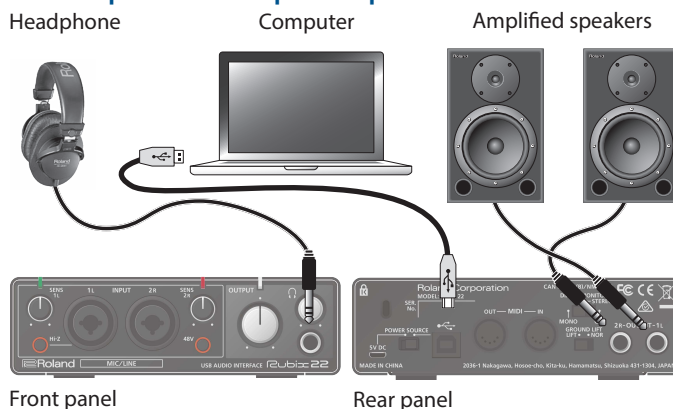

2. If you're using the Rubix24, turn the [DIRECT MONITOR] knob all the way to the left.

Windows

3. Open "Control Panel," click the [Hardware and Sound] icon, and then click the [Sound] icon.

If you're using the icon view or the classic view, double-click the [Sound] icon.

4. Right-click Rubix22 / Rubix24 / Rubix44, and then click [Test] to check the sound.

Mac OS

3. Open "System Preferences," and click the [Sound] icon.
4. [Output] tab → From "Select a device for sound output," click Rubix22 / Rubix24 / Rubix44.
5. [Sound Effects] tab → Set the "Play sound effects through" to the "Selected sound output device."
6. Click the [Alert volume] slider and check the volume.

Setting the Size of the Audio Buffer (Windows Only)

Use the control panel to set the size of the audio buffer.

How audio buffer size is related to latency

When audio data is transferred between the computer and the Rubix, the audio data is temporarily accumulated in the audio buffer (a type of memory). This allows audio data to be transferred smoothly without dropouts.

You can use the **"USB buffer"** setting to change the size of the audio buffer. Increasing the size makes data transfer more stable, but has the disadvantage of delaying the sound (**"latency"**).

The ideal setting is the setting with the minimum delay that allows stable transfer of audio data.

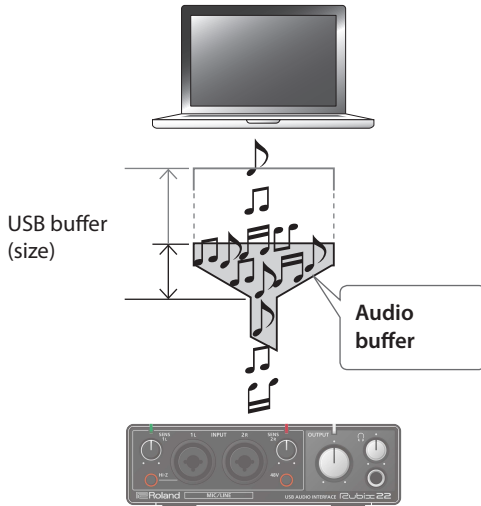

1. Access the control panel as follows.

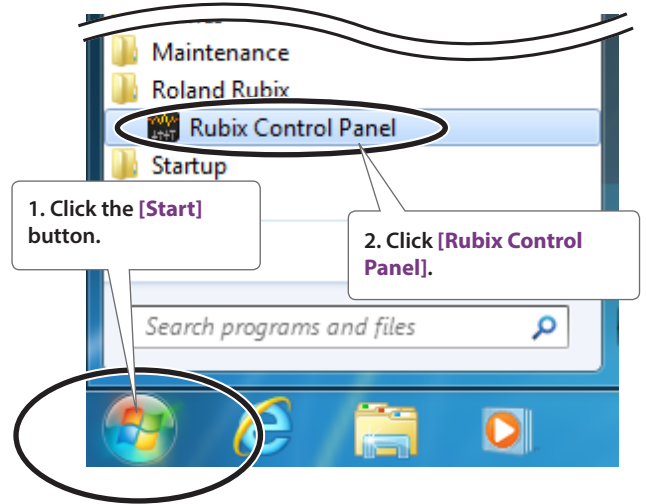

The control panel appears.

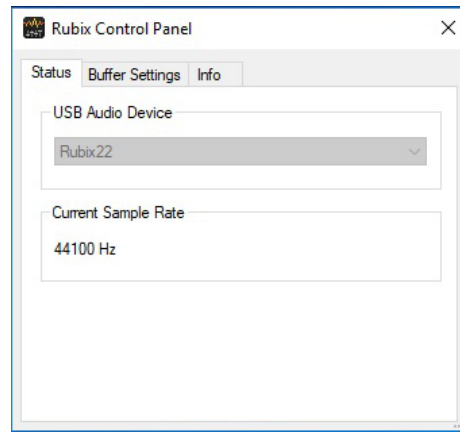

2. Click the [Buffer Settings] tab.

The buffer setting screen appears.

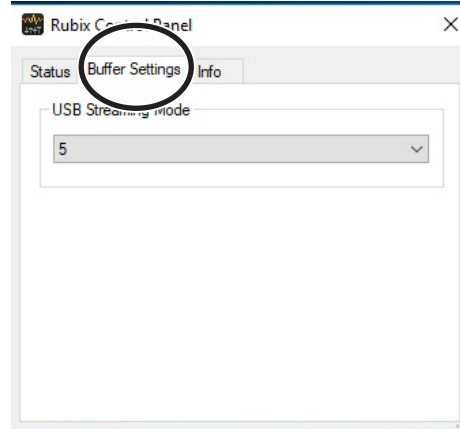

3. In “USB Streaming Mode,” select the most appropriate setting.

Select the setting with the shortest delay that still allows stable audio playback.

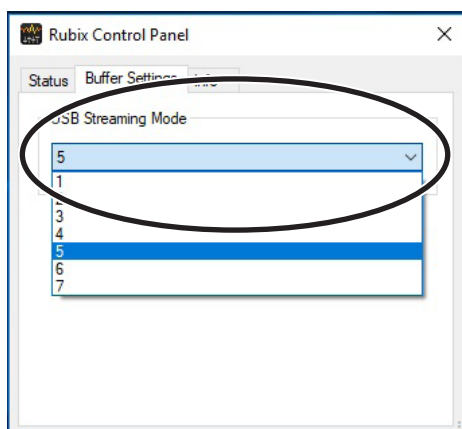

Setting	Stability	Latency
1	Low	Short (fast)
:	:	:
7	High	Long (slow)

MEMO

Refer to “**How audio buffer size is related to latency**” (p. 16), and choose the appropriate setting.

Using the Rubix

Playing Back

Connect the Rubix to a computer or iPad using the USB cable. By connecting headphones or amplified speakers as shown in the illustration, you can monitor playback from your DAW software or the sound from an instrument or audio device connected to the Rubix.

* To prevent malfunction and equipment failure, always turn down the volume, and turn off all the units before making any connections.



Front panel

Amplified speakers



For details on connecting the Rubix to your computer or iPad, refer to **“Getting Ready to Use the Rubix”** (p. 10)

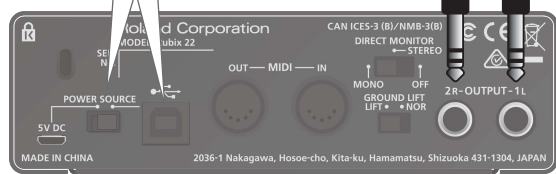

Rear panel

Recording

Audio signals from the INPUT jacks can be sent to your DAW software and recorded.

* To prevent malfunction and equipment failure, always turn down the volume, and turn off all the units before making any connections.

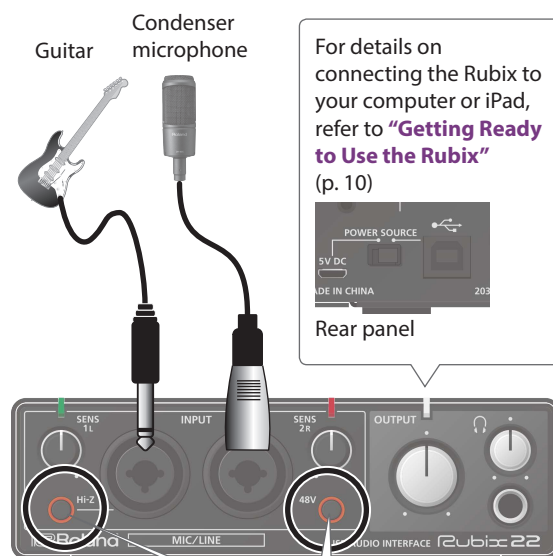

Front panel

When connecting devices to the INPUT jacks, check the settings of the [48V] button (p. 2, p. 4, p. 7) and [Hi-Z] button (p. 2, p. 4, p. 7).

Example:

- Connect a guitar to the INPUT 1L jack.
 - ➔ Set the [Hi-Z] button to **“ON.”**
- Connect a condenser microphone to the INPUT 2R jack.
 - ➔ Set the [48V] button to **“ON.”**

Adjusting the Input Level

Use the [SENS 1L] knob and [SENS 2R] knob (on the Rubix44, the [SENS 1L] knob – [SENS 4R] knob) to adjust the input level so that the level indicator does not light red.



Using the Compressor/Limiter

The Rubix24 and Rubix44 let you use a compressor or limiter.

Compressor/Limiter Settings

Using a compressor makes the volume more consistent. Turning the [THRS] knob toward the right applies the compressor more strongly, and simultaneously raises the makeup gain (boosts the output level).

Using a limiter suppresses excessive volume.

Use the Rubix24 or Rubix44's [COMP/LIMIT TYPE] switch (rear panel) to change this setting.



Rear Panel

* The illustration shows the Rubix44

[COMP/LIMIT TYPE] switch	Explanation	Response
COMP1	When the input signal exceeds the level specified by the [THRS] knob, the level is restrained at a fixed proportion. This setting is suitable for instruments, such as percussion or guitar.	
COMP2	This compressor has a shorter attack time than COMP1, making it suitable for vocals (the effect applies more rapidly than COMP1).	
LIMIT	This is a limiter. It prevents clipping (distortion) from occurring when an unexpectedly loud signal is input. Signals that exceed the level specified by the [THRS] knob are limited. * Clipping distortion will occur if the input exceeds the capacity of the limiter.	

Troubleshooting

Problems When Installing the USB Driver (Windows Users)

Problem	Items to check	Action
Can't download the driver because there's no internet connection	If you have a different computer that is able to connect to the internet, you can save the downloaded driver on a USB flash drive and use that to install.	
A warning or error appears during installation	In the "Device Manager," do you see "Other device," "Unknown device," or a device for which "?", "!", or "x" is displayed?	Reinstall the USB driver (p. 10).
Installation does not finish The USB driver does not install Can't uninstall	Are you logged on with a user account that does not have administrator privileges?	Log on to the computer with a user account that has administrator privileges. For details, consult the administrator for your computer system.
	Are other programs or resident programs (such as antivirus programs) running?	Be sure to exit all other programs before installation.
	Is the Rubix connected to a bus-powered USB hub?	Use a USB hub that connects to a power supply.

Problems When Using the Rubix

Problem	Items to check	Action
I cannot select or use the Rubix device	Is the Rubix's power indicator off or flash?	Make sure that the Rubix is connected to the computer correctly. If that does not resolve the issue, reinstall the USB driver (p. 10).
	Is the Rubix's device name displayed?	Exit all software that's using the Rubix, and then try the following. <ul style="list-style-type: none"> • Reconnect the USB cable • Power-cycle the Rubix
	Is another program using the Rubix?	If that does not resolve the issue, reinstall the USB driver (p. 10).
	Did the computer enter standby (suspend) mode, hibernate mode, or sleep mode while the Rubix was connected?	Exit all software that's using the Rubix, and then try the following. <ul style="list-style-type: none"> • Reconnect the USB cable • Power-cycle the Rubix
	Did you disconnect and reconnect the USB cable or turn the power of the Rubix off while using the Rubix?	If that does not resolve the issue, restart the computer.
	Was the Rubix connected to the computer while the computer was starting up?	Connect the Rubix after the computer has started up. With some computers, the Rubix cannot be used if it is connected to the computer while the computer is starting up.
	Windows Are you using the Media Player included with Windows?	MIDI devices cannot be selected in Media Player. Use different software.
	Could two or more Rubix units be connected to a single computer?	You can't use two or more Rubix units with a single computer. Use one Rubix unit.
No sound is heard from the computer's speakers	This is not a malfunction.	When using the Rubix, no sound is heard from the computer's speakers. Connect headphones or an audio playback system (external monitors) to the Rubix.

Problem	Items to check	Action
The sound played by the computer is inaudible or too quiet	Can you hear sound by connecting headphones?	If you can hear sound through headphones connected to the PHONES jack, check that you have correctly connected your audio playback system (external monitors), and adjust the volume of your equipment. If the sound in your headphones is inaudible or too soft, check the other troubleshooting items.
	Is the [OUTPUT] knob of the Rubix turned down?	Use the Rubix's [OUTPUT] knob to adjust the volume.
	Could the volume of the application you're using be turned down?	Raise the volume in the application.
	Windows Is the computer's system volume setting turned down?	Use the following procedure to adjust system volume. <ol style="list-style-type: none"> 1. Open the "Control Panel" and set the display mode to "Category." 2. Click the [Hardware and Sound] icon, and then click the [Adjust system volume] icon. 3. After the volume mixer appears, select the Rubix's [OUT (Rubix22)] from the "Device" menu and adjust the volume.
My guitar is too quiet	Are you using the correct jack?	Connect your guitar to the INPUT 1L (or INPUT 3L) jack (p. 2, p. 4, p. 7).
	Is the [Hi-Z] button set to "OFF"?	Set the [Hi-Z] button to "ON" (p. 2, p. 4, p. 7).
	Is the input level too low?	Use the [SENS 1L] knob (or [SENS 3L] knob) to adjust the input level (p. 2, p. 4, p. 7).
	Could you be using a connection cable that contains a resistor?	Use a connection cable that does not contain a resistor.
My microphone is too quiet	Are you using the correct jack?	Connect your microphone with an XLR connector to the XLR connector (p. 2, p. 4, p. 7). The sound level will be very low if you use a microphone with a phone plug.
	Does the sensitivity of the microphone match the nominal input level of the Rubix?	The Rubix's microphone nominal input level is -60 dBu for the XLR connector, and -44 dBu for the TRS phone type jack. If the sensitivity of the microphone is low, the sound will be quiet.
When a signal is input via either the INPUT 1L or INPUT 2R jack only, only one channel is recorded	Is the DAW software configured to record in stereo? If so, the signal input via the INPUT 1L jack is recorded on the left channel, and the signal input via the INPUT 2R jack is recorded on the right channel.	Change the DAW software's settings so that it records in mono.
A device connected to one of the input jacks is distorting	Could the level indicator be lit red?	Turn the SENS knobs toward the left to reduce the input level (p. 2, p. 4, p. 7).

Problem	Items to check	Action
Sound is interrupted during playback or recording	Are multiple programs running?	Exit programs that are not in use.
	Did you adjust the software's audio buffer size?	If the software allows you to adjust the audio buffer size, change the buffer size. Refer to the documentation for your software.
	Windows Did you adjust the USB driver's audio buffer size?	Increase the size of the USB driver's audio buffer (p. 16).
	Windows Is the system software up to date?	Run Windows Update or Microsoft Update and make sure the system software is up to date.
	Are the drivers for the computer's internal chipset and graphics card up to date?	Update to the latest drivers.
	Are the drivers for the computer's LAN hardware (wired and wireless) up to date?	Install the latest LAN hardware drivers. If the problem is not resolved, disable the LAN.
	Windows Is the power management setting in Windows set to economy mode?	Use the following procedure to make "power option" settings in the control panel. <ol style="list-style-type: none"> Open "Control Panel," click [System and Security] or [System and Maintenance], and then click [Power Options]. If the control panel shows the icon view or classic view, click the [Power Options] icon. If you're using Windows 10, click the [Start] button → click [All apps] → click [Windows System] → click [Control Panel]. In "Choose a Power Plan," select [High Performance]. If you don't see the "High Performance" plan, click "Show Additional Plans." In high performance, click [Change Plan Settings]. Click [Change Detailed Power Settings]. In detailed settings, click [+] for "Hard Disk," and then click [+] for "Power-Off Hard Disk When the Following Time Elapses:" Click "Set." Click the [▼] that appears, and set "Setting (Minutes):" to "None." Click [OK]. Close the "Edit Plan Settings" screen.
	Windows Could the system performance settings be set to "Program" ?	Use the following procedure to make "System" settings in the control panel. <ol style="list-style-type: none"> Open "Control Panel," click [System and Security] or [System and Maintenance], and then click [System]. If the control panel shows the icon view or classic view, click the [System] icon. If you're using Windows 10, click the [Start] button → click [All apps] → click [Windows System] → click [Control Panel]. In the left column, click [Detailed System Settings]. If a "user account control" dialog box appears, click [Yes] or [Continue]. If you are asked to enter a password for an administrator account, log on to Windows as a user whose account type is "administrator," and make the settings again. In performance, click [Settings] and then click the [Detailed Settings] tab. Choose [Background Services], and click [OK]. Click [OK] to close "System Properties."
	Is the Rubix connected to a USB hub?	Connect the Rubix directly to one of the computer's USB ports.
Are you using the included USB cable?	You must use the included USB cable. Some commercially available USB cables do not meet the requirements of the USB standard, and this may prevent the Rubix from operating correctly.	

Problem	Items to check	Action
Sound is interrupted during playback or recording	<p>Windows</p> <p>Is the monitoring function of Windows turned on?</p>	<p>Use the following procedure to disable the monitoring function of Windows.</p> <ol style="list-style-type: none"> 1. Open the “Control Panel,” click the [Hardware and Sound] icon, and then click the [Sound] icon. If you have selected Icon view, click the [Sound]. 2. In the “Recording” area, click the Rubix’s [IN (Rubix)], and then click the [Properties] button. 3. Open the “Listen” tab and clear the [Listen to this device] check box. 4. Click the [OK] button to close the “Properties” window. 5. Click the [OK] button to close the “Sound” window.
	Did you try to play back or record immediately after the computer started up or after waking up from sleep mode?	Wait and try playing back or recording later.
	Could you be using the internet (LAN)?	Clicks or pops might occur in the sound if you’re using the internet (LAN). Try disabling the LAN.
	Could you have changed the sample rate?	<p>Try the followings.</p> <ul style="list-style-type: none"> • Increase the driver’s buffer size (Windows) • Increase the DAW application’s audio buffer size • Restart the DAW application
Noise or distortion occurs elsewhere than in the playback from my computer	Is a guitar connected?	<p>Move as far away from the computer as possible.</p> <p>If the noise decreases when you lower your guitar’s volume, it may be that your guitar’s pickups are being affected by noise from your computer or display.</p>
	Could you have left an unused microphone or guitar connected?	Disconnect the unused microphone or guitar, and turn the each SENS knob fully to the left in order to lower the input level.
	Could you have switched the DAW’s sample rate, or the sample rate for input and output of Windows sounds?	Before switching the sample rate, stop playback and minimize the volume.
	Could the MIDI sound module and the Rubix be connected to your computer, and the output of the MIDI sound module be connected to the INPUT 1L or INPUT 2R jack of the Rubix?	Connect the MIDI sound module and the Rubix to a USB hub that connects to a power supply.
	Have you connected the ground terminal?	You may be able to solve the problem by grounding a metal component of your computer or the ground pin of your computer’s AC adaptor. Also check whether there might be a device nearby that is emitting a strong electromagnetic field, such as a television or microwave oven.
	In some cases, moving the [GROUND LIFT] switch to “LIFT” might eliminate the noise.	
Recordings are too loud or too quiet	Is the input level appropriate?	Use the SENS knobs to adjust the input level of the Rubix. If your software has an input level adjustment, check the input level setting.
	Does the sensitivity of the microphone match the nominal input level of the Rubix?	The Rubix’s microphone nominal input level is -60 dBu for the XLR connector, and -44 dBu for the TRS phone type jack. If the sensitivity of the microphone is low, the sound will be soft.
I cannot play back or record	Are the software’s input device and output device configured?	Select the Rubix as the input and output device (p. 15).
	Is the sample rate set correctly?	<p>If the ASIO sample rate used by your DAW is different than the sample rate for input and output of Windows sounds, you might not hear any sound.</p> <p>Specify the same sample rate for your DAW and for Windows sounds.</p> <p>Also make sure that the sample rate for Windows sounds is the same for input and output.</p>
	Is the Rubix’s power indicator off or blink?	<p>Make sure that the Rubix is connected to the computer correctly.</p> <p>If that does not resolve the issue, reinstall the USB driver (p. 10).</p>
	Could a heavy processing load be placed on the computer while you’re using the Rubix?	<p>If a heavy processing load is being placed on the computer (such as by complex effect processing), the Rubix might stop working correctly.</p> <p>Temporarily stop playback/recording, and then resume playback/recording.</p> <p>Alternatively, exit software that you’re not using.</p>

Problem	Items to check	Action
I cannot play back or record	Could the volume of the application you're using be turned down?	Raise the volume in the application.
	<p>Windows</p> <p>Is the computer's system volume setting turned down?</p>	<p>Use the following procedure to adjust system volume.</p> <ol style="list-style-type: none"> 1. Open the "Control Panel" and set the display mode to "Category." 2. Click the [Hardware and Sound] icon, and then click the [Adjust system volume] icon. 3. After the volume mixer appears, select the Rubix's [OUT (Rubix22)] from the "Device" menu and adjust the volume.
	<p>Windows</p> <p>Are you using voice communication software?</p>	<p>Use the following procedure to disable automatic volume adjustment.</p> <ol style="list-style-type: none"> 1. Open the "Control Panel," click the [Hardware and Sound] icon, and then click the [Sound] icon. If you have selected Icon view, click the [Sound]. 2. In the [Communications] tab, set "When Windows detects communications activity" to [Do nothing]. 3. Click the [OK] button to close the "Sound" window.
<p>Windows</p> <p>Is the size of the USB driver's audio buffer too small?</p>	Increase the size of the USB driver's audio buffer (p. 16).	
Problem	Items to check	Action
I cannot play back or record 24-bit audio data	Does your software support 24-bit audio data?	Check whether your software supports playback and recording of 24-bit audio data.
	Is the software set correctly?	Make sure that your software is set to play and record 24-bit audio data.
Can't change the sample rate from the application	Are you playing back or recording?	Stop playback or recording, and then change the sample rate from your application.
	Could another application be using the Rubix?	Exit the other application, and then change the sample rate in the application that you want to use.
	Could the Windows sound control panel be open?	<p>In some cases, it might not be possible to change the sample rate while the Windows sound control panel is open.</p> <p>Close the Windows sound control panel.</p>

Mac OS X MIDI Settings

Here's how to configure the MIDI settings for Mac OS X.

1. In the Mac OS X Finder, open the **[Applications]** folder and then the **[Utilities]** folder, and then double-click **[Audio MIDI Setup]**.
2. Click **[Show MIDI Window]** in the **[Window]** menu.
3. Confirm that **[Rubix22]** (or Rubix24, Rubix44) appears in the "MIDI Studio" window or the "Audio MIDI Setup" dialog box.
If **[Rubix22]** (or Rubix24, Rubix44) does not appear or if it is grayed out, it means that the Rubix is not being detected properly. In this case, click the **[Rescan MIDI]** icon. Also, try turning the Rubix off and then on again.
4. Click the **[Add Device]** icon once.
One **[new external device]** icon will appear.
5. Click the added **[new external device]** icon and then click the **[Show Info]** icon.
6. Enter "Rubix" in the **[Device Name]** field and then click the **[Apply]** button.

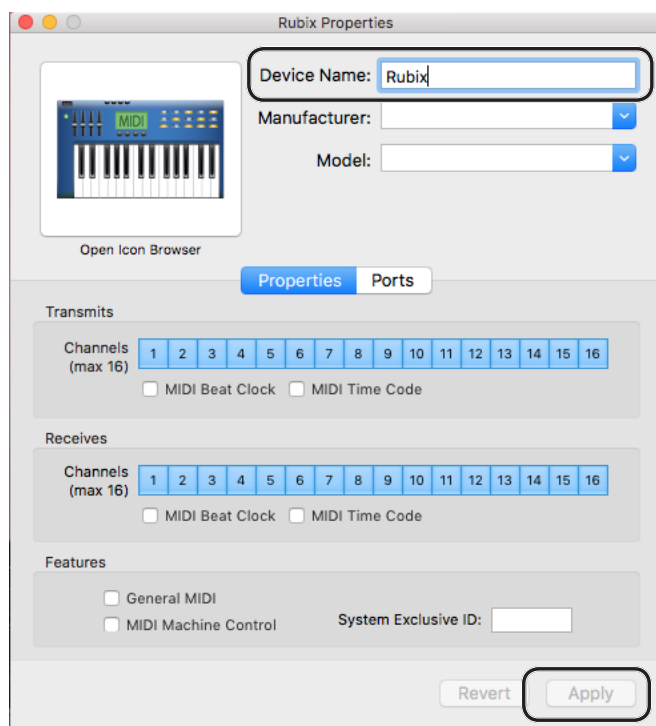

7. Using your mouse, drag and connect the **[▼]** **[▲]** buttons (which represent the input/output ports of each device) of the existing **[Rubix22]** and the newly added **[Rubix]** so that they are connected as shown in the figure.

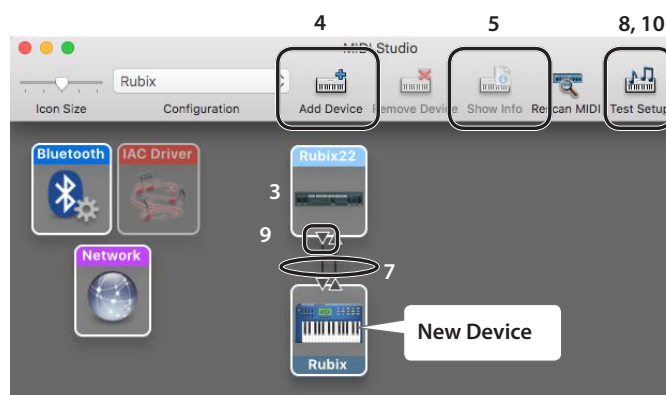

8. Click the **[Test Setup]** icon.
The **[Test Setup]** icon turns on (blue).

MEMO

If you have a sound module connected to the Rubix's MIDI OUT connector, a fairly loud sound will be heard when you perform the next step. Reduce the volume of your sound module before continuing.

9. Click the Rubix22's **[▼]** button.
A confirmation sound is played from the sound module.
10. Click the **[Test Setup]** icon.
The **[Test Setup]** icon turns off (gray).
11. Close the "MIDI Studio" window or the "Audio MIDI Setup" window.

Block Diagram

Rubix 22 BLOCK DIAGRAM

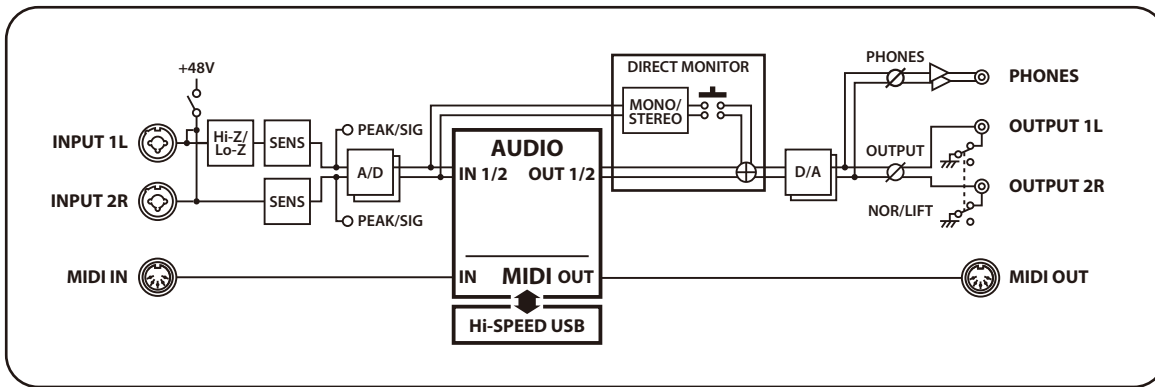

Rubix 24 BLOCK DIAGRAM

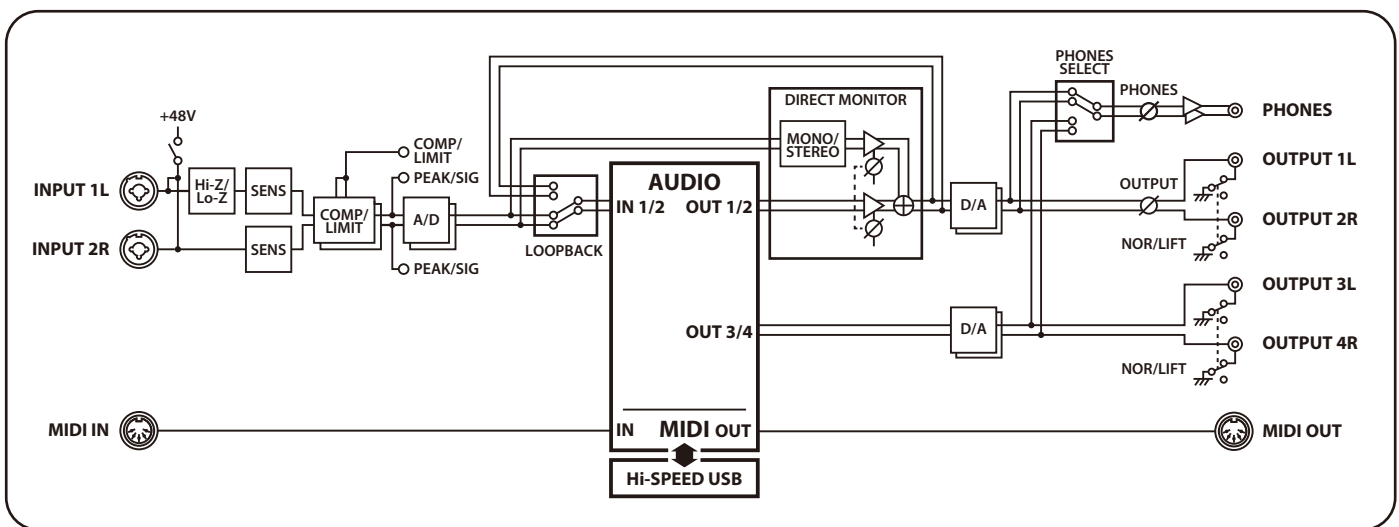

Rubix 44 BLOCK DIAGRAM

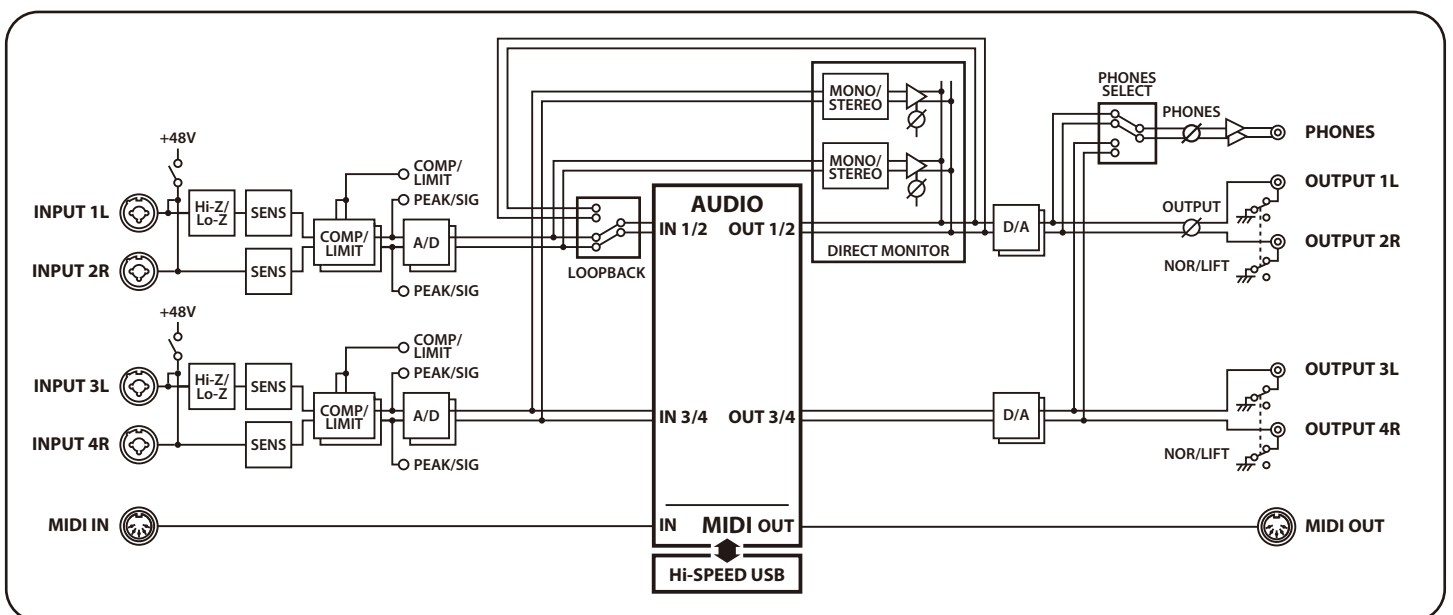

Specifications

Roland Rubix22: USB Audio Interface

[System]	
Number of Audio Record/Playback Channels	Record: 2 channels Playback: 2 channels
Signal Processing	PC interface: 24 bits AD/DA conversion: 24 bits
Sample Rate	AD/DA conversion: 44.1 kHz, 48 kHz, 96 kHz, 192 kHz
Interface	Hi-Speed USB MIDI IN, OUT
Connectors	INPUT (1L, 2R) connectors: XLR type (balanced, phantom power: +48 V, 6 mA Max *1) INPUT (1L, 2R) jacks *2: 1/4-inch TRS phone type (balanced) PHONES jack: Stereo 1/4-inch phone type OUTPUT (1L, 2R) jacks: 1/4-inch TRS phone type (impedance balanced) MIDI (IN, OUT) connectors USB port: USB B type DC 5V port: USB Micro-B type *1 Current value per channel. *2 INPUT 1L supports high impedance
Controllers	SENS 1L, 2R knobs Hi-Z switch 48V switch OUTPUT knob PHONES knob POWER SOURCE switch DIRECT MONITOR switch GROUND LIFT switch
Indicators	Level indicators (1L, 2R) POWER indicator Hi-Z indicator 48V indicator

[Characteristics]	
Nominal Input Level	INPUT (1L, 2R) connectors (XLR type): -60 – -12 dBu INPUT (1L, 2R) jacks (1/4-inch TRS phone type): -44 – +4 dBu
Maximum Input Level	INPUT (1L, 2R) connectors (XLR type): +2 dBu INPUT (1L, 2R) jacks (1/4-inch TRS phone type): +18 dBu
Nominal Output Level	OUTPUT (1L, 2R) jacks: -6 dBu (impedance balanced)
Maximum Output Level	OUTPUT (1L, 2R) jacks: +8 dBu (impedance balanced)
PHONES Maximum Output Power	20 mW + 20 mW (L + R, 47 ohms load)
Headroom	14 dB
Input Impedance	INPUT (1L, 2R) connectors (XLR type): 4 k ohms or greater (balanced) INPUT (1L, 2R) jacks (1/4-inch TRS phone type): 15 k ohms or greater (balanced) INPUT (1L) jack (1/4-inch phone type *3): 500 k ohms or greater *3 When the Hi-Z is turned on
Output Impedance	OUTPUT (1L, 2R) jacks: 2 k ohms (balanced) PHONES jack: 47 ohms
Frequency Response * for each sample rate)	192.0 kHz: 20 Hz–60 kHz (+0/-2 dB), 20 Hz–90 kHz (+0/-10 dB) 96.0 kHz: 20 Hz–40 kHz (+0/-2 dB) 48.0 kHz: 20 Hz–22 kHz (+0/-2 dB) 44.1 kHz: 20 Hz–20 kHz (+0/-2 dB)
Residual Noise Level	INPUT (1L, 2R) → OUTPUT (1L, 2R): -94 dBu typ. (SENS 1L, SENS 2R knobs: min., input terminated with 600 ohms, IHF-A, typ.)
Dynamic Range	AD block INPUT (1L, 2R) jacks: 104 dB typ. (SENS 1L, SENS 2R knobs: min.) DA block OUTPUT (1L, 2R) jacks: 109 dB typ.

[Other]	
Power Supply	Supplied from the computer via USB, 5V DC
Current Draw	500 mA
Operating System	Microsoft(R) Windows(R) 7, Windows(R) 8, Windows(R) 8.1, Windows(R) 10 Apple Mac OS X 10.10 or later Apple iOS 9 or later
Dimensions	145 (W) x 165 (D) x 46 (H) mm 5-3/4 (W) x 6-1/2 (D) x 1-13/16 (H) inches
Weight (main unit only)	1.0 kg 2 lbs 4 oz
Accessories	Setup Guide Leaflet “USING THE UNIT SAFELY” USB cable Ableton Live Lite Serial Number Card

* 0 dBu = 0.775 Vrms

Roland Rubix24: USB Audio Interface

[System]	
Number of Audio Record/Playback Channels	Record: 2 channels Playback: 4 channels
Signal Processing	PC interface: 24 bits AD/DA conversion: 24 bits
Sample Rate	AD/DA conversion: 44.1 kHz, 48 kHz, 96 kHz, 192 kHz
Interface	Hi-Speed USB MIDI IN, OUT
Connectors	INPUT (1L, 2R) connectors: XLR type (balanced, phantom power: +48 V, 6 mA Max *1) INPUT (1L, 2R) jacks *2: 1/4-inch TRS phone type (balanced) PHONES jack: Stereo 1/4-inch phone type OUTPUT (1L, 2R, 3L, 4R) jacks: 1/4-inch TRS phone type (impedance balanced) MIDI (IN, OUT) connectors USB port: USB B type 5V DC port: USB Micro-B type *1 Current value per channel. *2 INPUT 1L supports high impedance
Controllers	SENS 1L, 2R knobs Hi-Z switch 48V switch THRS knob COMP/LIMIT switch DIRECT MONITOR knob MONO switch OUTPUT knob PHONES knob POWER SOURCE switch LOOPBACK switch COMP/LIMIT TYPE switch GROUND LIFT switch PHONES SOURCE switch
Indicators	Level indicators (1L, 2R) Reduction indicator POWER indicator Hi-Z indicator 48V indicator COMP/LIMIT indicator MONO indicator

[Characteristics]	
Nominal Input Level	INPUT (1L, 2R) connectors (XLR type): -60– -12 dBu INPUT (1L, 2R) jacks (1/4-inch TRS phone type): -44– +4 dBu
Maximum Input Level	INPUT (1L, 2R) connectors (XLR type): +2 dBu INPUT (1L, 2R) jacks (1/4-inch TRS phone type): +18 dBu
Nominal Output Level	OUTPUT (1L, 2R, 3L, 4R) jacks: -6 dBu (impedance balanced)
Maximum Output Level	OUTPUT (1L, 2R, 3L, 4R) jacks: +8 dBu (impedance balanced)
PHONES Maximum Output Power	20 mW + 20 mW (L + R, 47 ohms load)
Headroom	14 dB
Input Impedance	INPUT (1L, 2R) connectors (XLR type): 4 k ohms or greater (balanced) INPUT (1L, 2R) jacks (1/4-inch TRS phone type): 15 k ohms or greater (balanced) INPUT (1L) jack (1/4-inch phone type *3): 500 k ohms or greater *3 When the Hi-Z is turned on
Output Impedance	OUTPUT (1L, 2R, 3L, 4R) jacks: 2 k ohms (balanced) PHONES jack: 47 ohms
Frequency Response * for each sample rate)	192.0 kHz: 20 Hz–60 kHz (+0/-4 dB), 20 Hz–90 kHz (+0/-10 dB) 96.0 kHz: 20 Hz–40 kHz (+0/-2 dB) 48.0 kHz: 20 Hz–22 kHz (+0/-2 dB) 44.1 kHz: 20 Hz–20 kHz (+0/-2 dB)
Residual Noise Level	INPUT (1L, 2R) → OUTPUT (1L, 2R): -94 dBu typ. (SENS 1L, SENS 2R knobs: min., input terminated with 600 ohms, IHF-A, typ.)
Dynamic Range	AD block INPUT (1L, 2R) jacks: 104 dB typ. (SENS 1L, SENS 2R knobs: min.) DA block OUTPUT (1L, 2R, 3L, 4R) jacks: 109 dB typ.

[Other]	
Power Supply	Supplied from the computer via USB, 5V DC
Current Draw	500 mA
Operating System	Microsoft(R) Windows(R) 7, Windows(R) 8, Windows(R) 8.1, Windows(R) 10 Apple Mac OS X 10.10 or later Apple iOS 9 or later
Dimensions	183 (W) x 165 (D) x 46 (H) mm 7-1/4 (W) x 6-1/2 (D) x 1-13/16 (H) inches
Weight (main unit only)	1.2 kg 2 lbs 11 oz
Accessories	Setup Guide Leaflet "USING THE UNIT SAFELY" USB cable Ableton Live Lite Serial Number Card

* 0 dBu = 0.775 Vrms

Roland Rubix44: USB Audio Interface

[System]		[Characteristics]	
Number of Audio Record/Playback Channels	Record: 4 channels Playback: 4 channels	Nominal Input Level	INPUT (1L, 2R, 3L, 4R) connectors (XLR type): -60–-12 dBu INPUT (1L, 2R, 3L, 4R) jacks (1/4-inch TRS phone type): -44–+4 dBu
Signal Processing	PC interface: 24 bits AD/DA conversion: 24 bits	Maximum Input Level	INPUT (1L, 2R, 3L, 4R) connectors (XLR type): +2 dBu INPUT (1L, 2R, 3L, 4R) jacks (1/4-inch TRS phone type): +18 dBu
Sample Rate	AD/DA conversion: 44.1 kHz, 48 kHz, 96 kHz, 192 kHz	Nominal Output Level	OUTPUT (1L, 2R, 3L, 4R) jacks: -6 dBu (impedance balanced)
Interface	Hi-Speed USB MIDI IN, OUT	Maximum Output Level	OUTPUT (1L, 2R, 3L, 4R) jacks: +8 dBu (impedance balanced)
Connectors	INPUT (1L, 2R, 3L, 4R) connectors: XLR type (balanced, phantom power: +48 V, 6 mA Max *1) INPUT (1L, 2R, 3L, 4R) jacks *2: 1/4-inch TRS phone type (balanced) PHONES jack: Stereo 1/4-inch phone type OUTPUT (1L, 2R, 3L, 4R) jacks: 1/4-inch TRS phone type (impedance balanced) MIDI (IN, OUT) connectors USB port: USB B type DC IN jack *1 Current value per channel. *2 INPUT 1L, 3L support high impedance	PHONES Maximum Output Power	20 mW + 20 mW (L + R, 47 ohms load)
Controllers	SENS 1L, 2R, 3L, 4R knobs Hi-Z switches 48V switches THRS knobs COMP/LIMIT switches DIRECT MONITOR 1/2 knob DIRECT MONITOR 3/4 knob MONO switches OUTPUT knob PHONES knob POWER switch GROUND LIFT switch PHONES SOURCE switch LOOPBACK switch COMP/LIMIT TYPE 1/2 switch COMP/LIMIT TYPE 3/4 switch	Headroom	14 dB
Indicators	Level indicators (1L, 2R, 3L, 4R) Reduction indicators POWER indicator Hi-Z indicators 48V indicators COMP/LIMIT indicators MONO indicators	Input Impedance	INPUT (1L, 2R, 3L, 4R) connectors (XLR type): 4 k ohms or greater (balanced) INPUT (1L, 2R, 3L, 4R) jacks (1/4-inch TRS phone type): 15 k ohms or greater (balanced) INPUT (1L, 3L) jacks (1/4-inch phone type): 500 k ohms or greater *3 When the Hi-Z is turned on
		Output Impedance	OUTPUT (1L, 2R, 3L, 4R) jacks: 2 k ohms (balanced) PHONES jack: 47 ohms
		Frequency Response * for each sample rate)	192.0 kHz: 20 Hz–60 kHz (+0/-2 dB), 20 Hz–90 kHz (+0/-8 dB) 96.0 kHz: 20 Hz–40 kHz (+0/-2 dB) 48.0 kHz: 20 Hz–22 kHz (+0/-2 dB) 44.1 kHz: 20 Hz–20 kHz (+0/-2 dB)
		Residual Noise Level	INPUT (1L, 2R) → OUTPUT (1L, 2R): -94 dBu typ. (SENS 1L, SENS 2R knobs: min., input terminated with 600 ohms, IHF-A, typ.)
		Dynamic Range	AD block INPUT (1L, 2R, 3L, 4R) jacks: 104 dB typ. (SENS 1L, SENS 2R knobs: min.) DA block OUTPUT (1L, 2R, 3L, 4R) jacks: 109 dB typ.
[Other]			
Power Supply	AC adaptor		
Current Draw	750 mA		
Operating System	Microsoft(R) Windows(R) 7, Windows(R) 8, Windows(R) 8.1, Windows(R) 10 Apple Mac OS X 10.10 or later Apple iOS 9 or later		
Dimensions	310 (W) x 165 (D) x 46 (H) mm 12-1/4 (W) x 6-1/2 (D) x 1-13/16 (H) inches		
Weight (main unit only)	1.8 kg 4 lbs		
Accessories	Setup Guide Leaflet “USING THE UNIT SAFELY” AC adaptor Power cord USB cable Ableton Live Lite Serial Number Card		

* 0 dBu = 0.775 Vrms

For the USA

FEDERAL COMMUNICATIONS COMMISSION RADIO FREQUENCY INTERFERENCE STATEMENT

This equipment has been tested and found to comply with the limits for a Class B digital device, pursuant to Part 15 of the FCC Rules. These limits are designed to provide reasonable protection against harmful interference in a residential installation. This equipment generates, uses, and can radiate radio frequency energy and, if not installed and used in accordance with the instructions, may cause harmful interference to radio communications. However, there is no guarantee that interference will not occur in a particular installation. If this equipment does cause harmful interference to radio or television reception, which can be determined by turning the equipment off and on, the user is encouraged to try to correct the interference by one or more of the following measures:

- Reorient or relocate the receiving antenna.
- Increase the separation between the equipment and receiver.
- Connect the equipment into an outlet on a circuit different from that to which the receiver is connected.
- Consult the dealer or an experienced radio/TV technician for help.

This device complies with Part 15 of the FCC Rules. Operation is subject to the following two conditions:

- (1) this device may not cause harmful interference, and
- (2) this device must accept any interference received, including interference that may cause undesired operation.

This equipment requires shielded interface cables in order to meet FCC class B limit.

Any unauthorized changes or modifications not expressly approved by the party responsible for compliance could void the user's authority to operate the equipment.

For Canada

CAN ICES-3 (B)/NMB-3 (B)

For Korea

사용자 안내문

기종별	사용자 안내문
B 급 기기 (가정용 방송통신기자재)	이 기기는 가정용(B 급) 전자파적합기기로서 주로 가정에서 사용하는 것을 목적으로 하며, 모든지역에서 사용할 수 있습니다.

For C.A. US (Proposition 65)

WARNING

This product contains chemicals known to cause cancer, birth defects and other reproductive harm, including lead.

Manufacturer: 2036-1 Nakagawa, Hosoe-cho, Kita-ku, Hamamatsu, Shizuoka 431-1304, JAPAN

Importer: ENA 23 Zone 1 nr. 1620 Klaus-Michael Kuehnelaan 13, 2440 Geel, BELGIUM



For the USA

DECLARATION OF CONFORMITY Compliance Information Statement

Model Name : Rubix22, Rubix24, Rubix44
 Type of Equipment : USB Audio Interface
 Responsible Party : Roland Corporation U.S.
 Address : 5100 S. Eastern Avenue Los Angeles, CA 90040-2938
 Telephone : (323) 890-3700

For EU Countries

- UK** This symbol indicates that in EU countries, this product must be collected separately from household waste, as defined in each region. Products bearing this symbol must not be discarded together with household waste.
- DE** Dieses Symbol bedeutet, dass dieses Produkt in EU-Ländern getrennt vom Hausmüll gesammelt werden muss gemäß den regionalen Bestimmungen. Mit diesem Symbol gekennzeichnete Produkte dürfen nicht zusammen mit den Hausmüll entsorgt werden.
- FR** Ce symbole indique que dans les pays de l'Union européenne, ce produit doit être collecté séparément des ordures ménagères selon les directives en vigueur dans chacun de ces pays. Les produits portant ce symbole ne doivent pas être mis au rebut avec les ordures ménagères.
- IT** Questo simbolo indica che nei paesi della Comunità europea questo prodotto deve essere smaltito separatamente dai normali rifiuti domestici, secondo la legislazione in vigore in ciascun paese. I prodotti che riportano questo simbolo non devono essere smaltiti insieme ai rifiuti domestici. Ai sensi dell'art. 13 del D.Lgs. 25 luglio 2005 n. 151.
- ES** Este símbolo indica que en los países de la Unión Europea este producto debe recogerse aparte de los residuos domésticos, tal como está regulado en cada zona. Los productos con este símbolo no se deben depositar con los residuos domésticos.
- PT** Este símbolo indica que nos países da UE, a recolha deste produto deverá ser feita separadamente do lixo doméstico, de acordo com os regulamentos de cada região. Os produtos que apresentem este símbolo não deverão ser eliminados juntamente com o lixo doméstico.
- NL** Dit symbool geeft aan dat in landen van de EU dit product gescheiden van huishoudelijk afval moet worden aangeboden, zoals bepaald per gemeente of regio. Producten die van dit symbool zijn voorzien, mogen niet samen met huishoudelijk afval worden verwijderd.
- DK** Dette symbol angiver, at i EU-lande skal dette produkt opsamles adskilt fra husholdningsaffald, som defineret i hver enkelt region. Produkter med dette symbol må ikke smides ud sammen med husholdningsaffald.
- NO** Dette symbolet indikerer at produktet må behandles som spesialavfall i EU-land, iht. til retningslinjer for den enkelte regionen, og ikke kastes sammen med vanlig husholdningsavfall. Produkter som er merket med dette symbolet, må ikke kastes sammen med vanlig husholdningsavfall.

- SE** Symbolen anger att i EU-länder måste den här produkten kasseras separat från hushållsavfall, i enlighet med varje regions bestämmelser. Produkter med den här symbolen får inte kasseras tillsammans med hushållsavfall.
- FI** Tämä merkintä ilmaisee, että tuote on EU-maissa kerättävä erillään kotitalousjätteistä kunkin alueen voimassa olevien määräysten mukaisesti. Tällä merkinnällä varustettuja tuotteita ei saa hävittää kotitalousjätteiden mukana.
- HU** Ez a szimbólum azt jelenti, hogy az Európai Unióban ezt a terméket a háztartási hulladéktól elkülönítve, az adott régióban érvényes szabályozás szerint kell gyűjteni. Az ezzel a szimbólummal ellátott termékeket nem szabad a háztartási hulladék közé dobni.
- PL** Symbol oznacza, że zgodnie z regulacjami w odpowiednim regionie, w krajach UE produktu nie należy wyrzucać z odpadami domowymi. Produktów opatrzonych tym symbolem nie można utylizować razem z odpadami domowymi.
- CZ** Tento symbol udává, že v zemích EU musí být tento výrobek sbírán odděleně od domácího odpadu, jak je určeno pro každý region. Výrobky nesoucí tento symbol se nesmí vyhazovat spolu s domácím odpadem.
- SK** Tento symbol vyjadruje, že v krajinách EÚ sa musí zber tohto produktu vykonávať oddelene od domového odpadu, podľa nariadení platných v konkrétnej krajine. Produkty s týmto symbolom sa nesmú vyhazovať spolu s domovým odpadom.
- EE** See sümbol näitab, et EL-i maades tuleb see toode olempriigist eraldi koguda, nii nagu on igas piirkonnas määratletud. Selle sümboliga märgitud tooteid ei tohi ära visata koos olmeprügiga.
- LT** Šis simbolis rodo, kad ES šalyse šis produktas turi būti surenkamas atskirai nuo buitinių atliekų, kaip nustatyta kiekvienoje regione. Šiuo simboliu paženklininti produktai neturi būti išmetami kartu su buitiniams atliekomis.
- LV** Šis simbols norāda, ka ES valstīs šo produktu jāievāc atsevišķi no mājsaimniecības atkritumiem, kā noteikts katrā reģionā. Produkts ar šo simbolu nedrīkst izmest kopā ar mājsaimniecības atkritumiem.
- SI** Ta simbol označuje, da je treba proizvod v državah EU zbirati ločeno od gospodinskih odpadkov, tako kot je določeno v vsaki regiji. Proizvoda s tem znakom ni dovoljeno odlagati skupaj z gospodinskimi odpadki.
- GR** Το σύμβολο αυτό υποδηλώνει ότι στις χώρες της Ε.Ε. το συγκεκριμένο προϊόν πρέπει να συλλέγεται χωριστά από τα υπόλοιπα οικιακά απορρίμματα, σύμφωνα με όσα προβλέπονται σε κάθε περιοχή. Τα προϊόντα που φέρουν το συγκεκριμένο σύμβολο δεν πρέπει να απορρίπτονται μαζί με τα οικιακά απορρίμματα.

For C.A. US (Proposition 65)**WARNING**

This product contains chemicals known to cause cancer, birth defects and other reproductive harm, including lead.